



# M710

## LABEL PRINTER

**The fastest, most advanced portable yet**

Get more done in less time



# About BRADY



**Once you have worked with BRADY, our name will stick with you, (just like our labels) because BRADY is one of the world's leading labelling and identification specialists.**

## Innovative

At BRADY we continue to improve. We have many customers from all industries, and we strive to be ahead of their needs by continuing to invest in research for even more performant solutions. By developing more user-friendly and efficient concepts, we give our thousands of customers the best in the market.

## Strength

At BRADY, we believe our biggest strength is the wide range of identification and safety solutions we can offer our customers, whether it's labelling the smallest component or complete signage for an entire warehouse. We're also proud to offer many products and services - from printers, scanners and software to service contracts and on-site training - that compliment any identification job. And don't forget, our wide network of expert distributors can always offer you a tailor-made solution to meet your specific requirements.

## Trust

For over a hundred years, BRADY has been connected with quality, trust and stability. We demand the best for your products and services, because we know, better than anyone, the importance of good and reliable identification. Identification looks like a small detail, but every professional knows that this kind of detail is crucial to any business.

## Inform

We also have specialised dealers in your region, who can answer all your identification, safety and labelling questions, specific to your activity. They will be happy to provide you with all kinds of options and solutions with no obligation.

**Microsoft is a trademark of Microsoft Corporation, Bluetooth is a trademark of Bluetooth Sig, Inc., Android is a trademark of Google Inc.**



Brady products are sold on the condition that the purchaser will test them in actual use and determine for himself/herself their suitability to his/her intended purpose. Brady warrants to the purchaser that Brady products are free from defects in material and workmanship but limits its obligation under this warranty to the replacement of the product which has been shown to Brady's satisfaction to have been defective at the time of its purchase.

The warranty does not extend to any persons who have acquired the product from the purchaser. It is in lieu of any other warranty, including every warranty of sale-ability, marketability or suitability for the intended purpose, and is also in lieu of any other obligation or liability on the part of Brady.

Under no circumstances will Brady be liable for losses, damage, costs or subsequent damage of whatever nature which may arise in connection with the use of, or inability to use, Brady's products.

# M710 Label Printer

## The Brady Advantage

When it comes to identification, safety and compliance, there's a clear advantage to working with Brady. We put our customers first in everything we do.

Our goal is to give you an unrivalled customer experience. We are relentlessly committed to performance and excellence - in our products, services and people.

Our products and solutions perform in ways that others simply can't match.

Our people perform in ways that regularly exceed your expectations. And our focus and discipline work toward solid, long-term performance for our customers.

In short, Brady is the company you trust when performance matters most.

**Learn more about the Brady Advantage at:**  
**[www.bradyeurope.com](http://www.bradyeurope.com)**

## Contents

- 4 One smart printer to print it all
- 5 M710 at a glance
- 6 Font sizes & symbol library
- 7 Applications
- 10 Advantages of labelling
- 11 What is a professional label?
- 12 M710 media offering
- 13 Ribbons
- 14 Electrical, voice/datacom identification
- 30 General & industrial identification
- 34 Safety & facility identification
- 38 Electronics identification
- 40 Laboratory identification
- 49 Master material index
- 52 Brady Workstation software suites
- 53 Printer specifications
- 54 M710 Printer and accessories
- 55 Brady Technical Service







# MORE SPEED. LESS MESS. Print on just about anything.

Take on more jobs, and get them done in record time with the all-new M710 Label Printer. Fast and flexible, it's your tool for seamless label creation from the shop to the field. Design and print with a mobile app, software or keyboard and colour touchscreen. Enjoy printing on the toughest materials around, plus extra durability from a Li-ION battery that lasts all day long. Better jobsite performance starts with the M710.



## GET MORE DONE WITH:



**LIGHTNING-FAST PRINT SPEEDS**



**SHOP-TO-FIELD FLEXIBILITY**



**MORE THAN 60 MATERIAL  
OPTIONS**



Watch the How-to-videos on our Brady YouTube channel.



Click or scan here

# M710 at a glance

## Seamless experience for larger applications

Print 76 mm per second. Cut labels automatically. Print 4,500 labels on a single charge.

Get the job done right on any jobsite with the M710. With built-in speed, plus added durability to withstand longer days and tougher work conditions, it's our most advanced printer yet. Connect to your work more ways with software or a mobile app designed for 100s of industrial applications. Then design and print using the keypad, your phone or a PC. When you're ready to take on more, make sure it's with the M710.

**2 YEAR  
WARRANTY**



**A** Prints up to 76 mm per second



**B** Easy material loading with bulk-size roll option



**C** USB port to import and save files, lists and graphics



**D** Rechargeable Li-Ion battery prints up to 4,500 labels on a single charge

# Get the job done right on any jobsite

## Optimise your performance with Brady materials

The M710 works hard behind the scenes so you can maintain high performance and work seamlessly. Driven by smart technology, it communicates with label materials and software for smoother label setup and printing. It recognizes and adjusts to material size, type, colour, quantity and compatibility, plus sets up proper burn settings and print speed. All this is automatic, saving you trial-and-error adjustments.



### SMART ROLLS

- ▶ Get the job done with over 50 high-performance materials and 1300+ label options.



### BULK ROLLS

- ▶ Save more - buy in bulk: more than 14 materials and 200+ label options.



### CUSTOM OPTIONS

- ▶ Have specific needs? Enjoy unlimited custom label options in 70+ different materials.



### Enjoy a more premium labelling experience with optimised Brady Authentic materials

Authentic materials work seamlessly with Brady printers to produce enhanced performance and reliability you just don't get with materials from the others. We've got you covered with the widest range of colours, finishes and targeted applications in the industry. Get authentic. Get better with Brady.

## Your time and cost-saving benefits include:



DECREASED SETUP TIME



FEWER LABEL ERRORS



COMPLIANT LABEL CREATION



REDUCED MATERIAL WASTE



Watch the How-to-videos on our Brady YouTube channel.



Click or scan here



# Applications

## Electrical, voice/datacom identification

**Wire & cable marking** for twisted pair data cables (UTP, FTP...), fibre optic cables, conductors, computer wires, electrical installation wires & cables, power & ground cables, energy cables...



*Sleeves*



*Self-lams*



*Wrap-around labels*



*Flags*



*Tags*

**Component marking** for patch panels, control panels, punch blocks, terminal blocks, breaker boxes, face-plates...



*Raised panels*

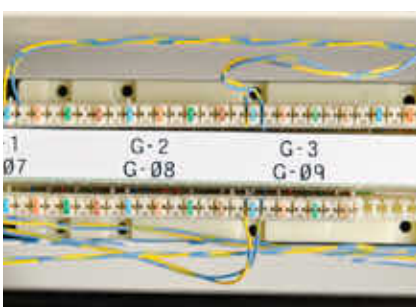

*Terminal block labels*



*Punch block & patch panel labels*

## General & industrial identification

**Asset & component marking** to be used on all kind of surfaces (smooth, rough, textured, low energy...).



*Rating & name plate labels*

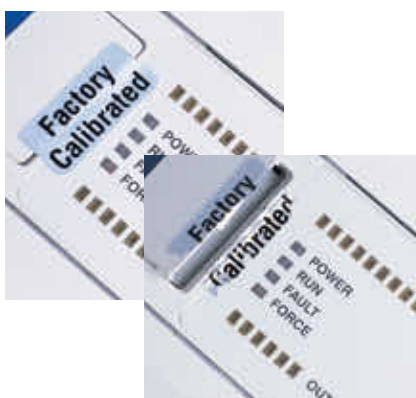

*Security identification labels*



*Rating plate labels*

# Applications

## Safety & facility identification



Pipe & valve marking



Food processing equipment marking



Exit & directional signs



Maintenance labels



Area & pathway marking



Safety signs and labels



Lean warehouse labels



Cold temperature labels



Magnetic labels

## Electronics identification

**Circuit Board Marking** for printed circuit board identification (also static dissipative), PCB SMT – Top/Bottom...



Polyester labels



Polyimide labels



Electrostatic Dissipative



# Applications

## Laboratory identification

**Specimen tracking identification** for sample tracking within histology labs: use barcode technology to prevent misdiagnosis.



*Straws & rods*



*Vial top labels*



*Vial & tube labels*



*Conical & large tube labels*

**Specimen process marking** supporting microscopic analysis of cells and tissues within pathology and clinical labs.



*Centrifuge/microcentrifuge labels*



*Slide labels*

**Specimen storage identification** supporting specimen collection and handling such as blood samples, cryo-samples etc.



*Cryo labels*



*Tissue cassette labels*



*Well plate labels*

**Lean lab identification** for general supplies marking.



*Bottle tamper seals*



*Bottles, flasks & dishes*



*General lab equipment labels*

# Advantages of labelling

## Ever lost time figuring out where each wire goes?

Durable professional labels that remain legible and stay attached in harsh conditions are extremely important to keep power, network, voice and data cables and components organised and running effectively.

## Professional identification on wires, cables and components enables you to:

- immediately recognise what needs checking during troubleshooting
- clearly mark parts for upcoming maintenance upgrades
- trace history, lifespan and supplier
- add safety warnings or precautions

Ask yourself how much time or money you lose while trying to trace an unidentified faulty cable, wire or component.

Ask yourself how fast pressure builds when machinery, production lines, servers and services are impacted.

**This is when professional labelling pays off big time.**

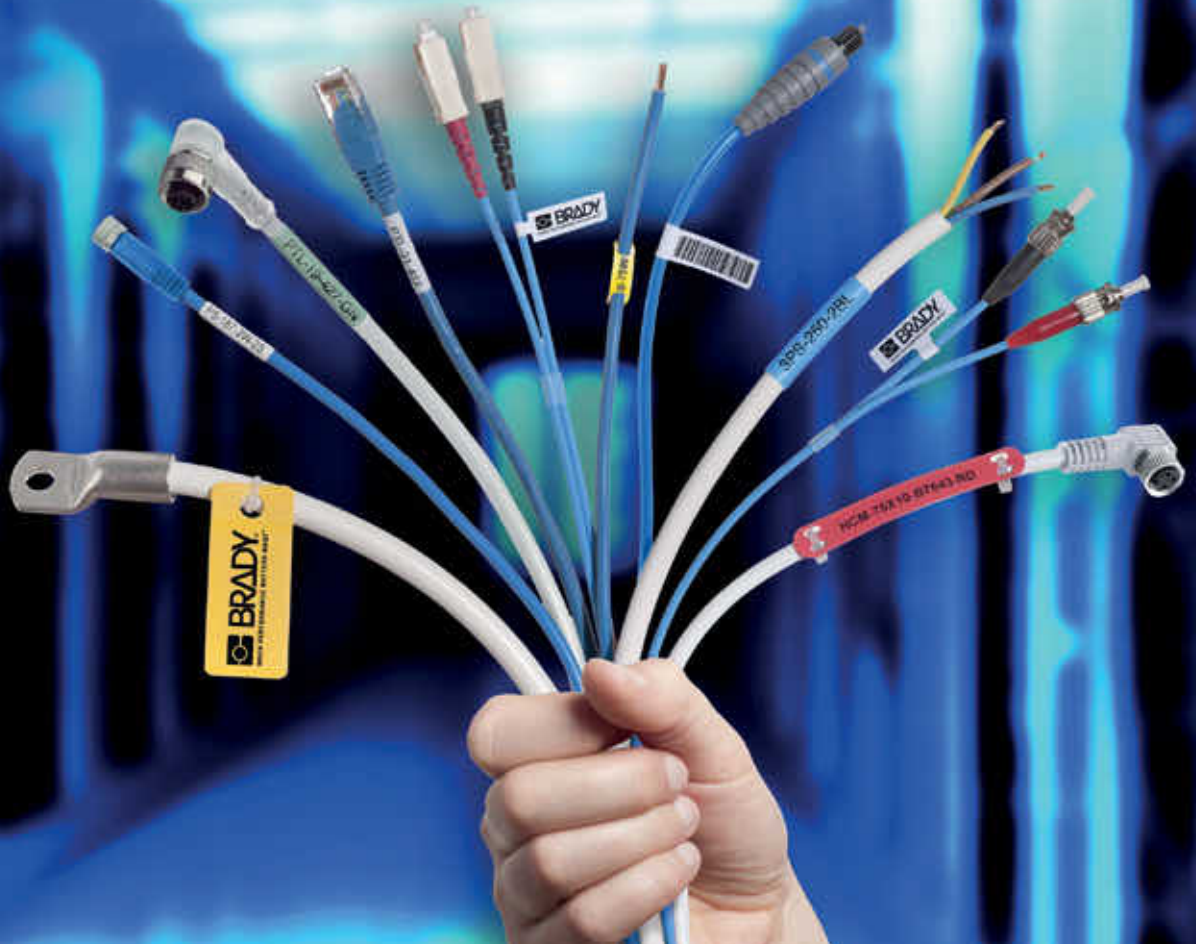

# What is a professional label?

**The combination of label liner, adhesive, substrate and topcoat provide a professional label's features, resistances, capabilities and durability.**

- 1** The topcoat gives the label its colour and finish, receives the print, and increases resistance against weathering, flames, chemicals or heat.
- 2** The substrate gives the label its form and provides tensile properties such as strength and flexibility and physical properties such as chemical and temperature resistance.
- 3** The adhesive attaches the label to a chosen surface type and ensures resistance against a set of environmental contexts.
- 4** The label liner is a very thin carrier that releases the self-adhesive label.

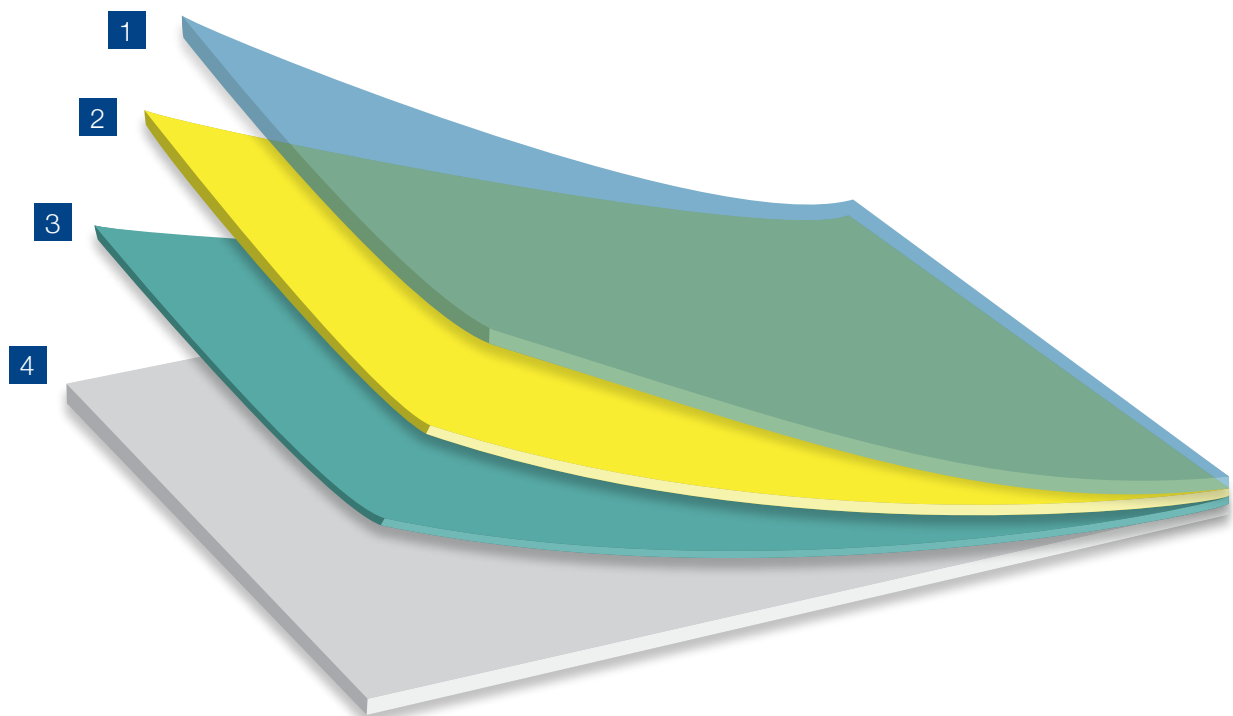

## Which label suits your needs best?

Request your Electrical, Tele- & Datacom Identification guide book to help you choose the optimal Brady label material for your application at:

**[www.bradyeurope.com/cableID](http://www.bradyeurope.com/cableID)**





# M710 media offering

We continuously try to improve & extend our label material offering, therefore make sure to check for firmware upgrades regularly, in order to make sure you always have access to the newest materials.

Material	
B-109	Polyethylene Tag
B-342	Heat-shrink Polyolefin Sleeve
B-348	Polyolefin
B-351	Tamper-resistant Vinyl
B-362	Tamper-resistant Metallised Vinyl
B-412	Polypropylene Tag
B-414	Polyester
B-417	Self-laminating Vinyl
B-422	Polyester
B-423	Polyester
B-424	Paper
B-425A	Polypropylene
B-427	Self-laminating Vinyl
B-428	Metallised Polyester
B-430	Polyester
B-435	Metallised Polyester
B-437	Polyvinylfluoride
B-459	Polyester
B-461	Self-laminating Polyester
B-472	Polyimide
B-473	Static Dissipative Polyester
B-481	StainerBondz™ Polyester
B-483A	Polyester
B-483A/B-634	Polyester with Polyester Overlamine
B-486B	Metallised Polyester
B-488	Polyester
B-489A	Polyester
B-490	FreezerBondz™ Polyester

Material	
B-492	FreezerBondz™ Polyester
B-498	Vinyl Cloth
B-499	Nylon Cloth
B-509	Magnetic Polyester
B-526	Phosphorescent Polyester
B-529	Polypropylene
B-530	Tamper-resistant Vinyl
B-549	Polyester
B-569	Polyester
B-581	Vinyl
B-582	Phosphorescent Polyester
B-584	Reflective Tape
B-595	Vinyl
B-642	Polyvinylfluoride
B-717	Polyimide
B-718	Polyimide
B-719	Polyimide
B-724	Polyimide
B-727	Polyimide
B-7593	Polyethylene Foam Laminate Polyester
B-7598	Polyester Tag
B-7599	Polyethylene Tag
B-7641	Heat-shrink Polyolefin Sleeve
B-7643	Thermoplastic Polyether Polyurethane
B-7696	Vinyl Tag
B-7697	Polyester
B-854	Metal Detectable Polyester
B-855	Polyester

## Compatible consumables



Most of the M610 consumables are compatible with the M710 Label Printer by using the black media guide provided with the M710. Extra media guides are available as an accessory (order ref.: M71-ADAPT-BK)



## Bulk packaging for high volume printing



Bulk labels are designed as a cost-effective solution for high volume labelling needs. Order references beginning with 'B' indicate bulk rolls. Bulk Label printing requires the media feeder and smart cell spool which are included in the bulk label material packaging.



### Get your custom M710 labels according to your specifications!

Frequently used custom labels include:

- Specific shapes and/or dimensions
- Specific colouring: material appearance through label colouring
- Specific materials to meet your requirements: chemical resistance, UV resistance, scratch resistance
- Specific printing or layout



Click or scan here



# Ribbons

All materials in the printer work with a series of M7 ribbons that easily fit into the printer. It is recommended to insert the ribbon before loading the consumable.



▶ Watch the how-to videos on our Brady YouTube channel.

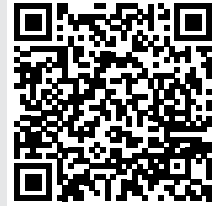

Order Reference	Colour	Roll Width (mm)	Roll Length (m)	Formulation	Notes / Details
M7-R10000	Black	50.00	45.72	Resin	Featuring a 5-second "drop and click" supply change, this smear-proof M710 Ribbon needs no threading or calibration. And, it's built super-tough for outdoor and industrial use.
M7-R10000-BL	Blue	50.00	45.72	Resin	Featuring a 5-second "drop and click" supply change, this smear-proof M710 Ribbon needs no threading or calibration. And, it's built super-tough for outdoor and industrial use.
M7-R10000-GN	Green	50.00	45.72	Resin	Featuring a 5-second "drop and click" supply change, this smear-proof M710 Ribbon needs no threading or calibration. And, it's built super-tough for outdoor and industrial use.
M7-R10000-RD	Red	50.00	45.72	Resin	Featuring a 5-second "drop and click" supply change, this smear-proof M710 Ribbon needs no threading or calibration. And, it's built super-tough for outdoor and industrial use.
M7-R10000-WT	White	50.00	45.72	Resin	Featuring a 5-second "drop and click" supply change, this smear-proof M710 Ribbon needs no threading or calibration. And, it's built super-tough for outdoor and industrial use.
M7-R10000-YL	Yellow	50.00	45.72	Resin	Featuring a 5-second "drop and click" supply change, this smear-proof M710 Ribbon needs no threading or calibration. And, it's built super-tough for outdoor and industrial use.
M7-R4400-WT	White	50.00	45.72	Resin	High density ribbon with excellent solvent resistance, high heat resistance, and super scratch resistance.
M7-R6000	Black	50.00	45.72	Resin	High density ribbon, excellent solvent resistance, high heat resistance, and super scratch resistance.
M7-R6200	Black	50.00	45.72	Resin	Designed for harsh environment labelling applications. Superior abrasion, chemical and heat resistance.
M7-R6400	Black	50.00	45.72	Resin	Ultra high chemical resistance at high temperatures. Superior solvent resistance.
M7-R6600	Black	50.00	45.72	Resin	Diesel resistant ribbon for thermal printing on Brady PermaSleeve and Heatex Sleeves. This ribbon has with excellent chemical and abrasion resistance
M7-R6800-WT	White	50.00	36.58	Resin	Strong environmental resistance against smearing and chemicals. Also, reliable, sharp-edge print quality to maximise bar code readability.
M7-R6900-BL	Blue	50.00	45.72	Resin	High density ribbon with excellent solvent resistance, high heat resistance, and super scratch resistance.
M7-R6900-GN	Green	50.00	45.72	Resin	High density ribbon with excellent solvent resistance, high heat resistance, and super scratch resistance.
M7-R6900-MA	Magenta	50.00	45.72	Resin	High density ribbon with excellent solvent resistance, high heat resistance, and super scratch resistance.
M7-R6900-RD	Red	50.00	45.72	Resin	High density ribbon with excellent solvent resistance, high heat resistance, and super scratch resistance.
M7-R6900-YL	Yellow	50.00	45.72	Resin	High density ribbon with excellent solvent resistance, high heat resistance, and super scratch resistance.
M7-R4300	Black	50.00	45.72	Wax/Resin	Strong environmental resistance against smearing and chemicals. Also, reliable, sharp-edge print quality to maximise bar code readability.
M7-R6700-WT	White	50.00	45.72	Wax/Resin	The White 6700 Series Thermal Transfer Ribbon offers high performance against scratching, smudging, and harsh chemicals. The ribbon can be used for printing on Brady's Black PermaSleeve™ materials

## ▶ Smart-Cell Technology

Brady Authentic labels have smart cell technology built into them, so labels are formatted automatically, without any guesswork on your part. They have bi-directional communication, which establishes the correct printer and software settings for optimal label performance and creation.



## Wire & cable marking



### PermaSleeve heat-shrink sleeve markers

- These heat-shrink sleeves are the ultimate in marker identification, protection, durability and aesthetic appearance.
- Fast shrink rate saves time and costs during installation.

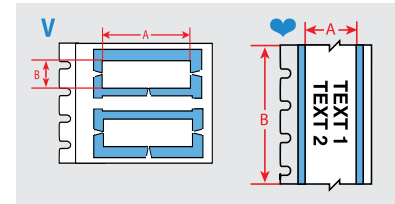

Diagram	Order Reference	Shrink Ratio	Colour	Sleeve Width A (mm)	Sleeve Height B (mm)	Sleeve Length B (mm)	Min. Wire Diameter (mm)	Max. Wire Diameter (mm)	Sleeves per roll	Printer Ribbon Series
B-342: Heat-shrink Polyolefin										
V	BM-094-1-342-2	3:1	White	12.70	4.62	-	0.58	2.03	5000	R6600
V	BM-094-175-342-2	3:1	White	22.23	4.62	-	0.58	2.03	5000	R4300
V	BM-094-1-342	3:1	White	25.40	4.62	-	0.58	2.03	2500	R4300
V	M7-094-1-342	3:1	White	25.40	4.62	-	0.58	2.03	100	R6600
V	BM-094-1-342-YL	3:1	Yellow	25.40	4.62	-	0.58	2.03	2500	R4300
V	M7-094-1-342-YL	3:1	Yellow	25.40	4.62	-	0.58	2.03	100	R6600
V	BM-094-175-342	3:1	White	44.45	4.62	-	0.58	2.03	2500	R4300
V	M7-094-175-342	3:1	White	44.45	4.62	-	0.58	2.03	100	R6600
V	BM-094-175-342-YL	3:1	Yellow	44.45	4.62	-	0.58	2.03	2500	R4300
V	M7-094-175-342-YL	3:1	Yellow	44.45	4.62	-	0.58	2.03	100	R6600
♥	BM7C-125-342	3:1	White	-	5.97	15.24	1.17	2.79	1	R4300
V	BM-125-1-342-2	3:1	White	12.70	5.97	-	1.17	2.79	2000	R4300
V	BM-125-175-342-3	3:1	White	14.81	5.97	-	1.17	2.79	3000	R4300
V	BM-125-175-342-2	3:1	White	22.23	5.97	-	1.17	2.79	2000	R6600
V	BM-125-1-342	3:1	White	25.40	5.97	-	1.17	2.79	1000	R4300
V	M7-125-1-342	3:1	White	25.40	5.97	-	1.17	2.79	100	R6600
V	BM-125-1-342-YL	3:1	Yellow	25.40	5.97	-	1.17	2.79	1000	R4300
V	M7-125-1-342-YL	3:1	Yellow	25.40	5.97	-	1.17	2.79	100	R6600
V	BM-125-175-342	3:1	White	44.45	5.97	-	1.17	2.79	1000	R4300
V	M7-125-175-342	3:1	White	44.45	5.97	-	1.17	2.79	100	R6600
V	BM-125-175-342-YL	3:1	Yellow	44.45	5.97	-	1.17	2.79	1000	R4300
V	M7-125-175-342-YL	3:1	Yellow	44.45	5.97	-	1.17	2.79	100	R6600
♥	BM7C-187-342	3:1	White	-	8.51	15.24	1.57	3.81	1	R4300
V	BM-187-175-342-4	3:1	White	11.10	8.51	-	1.57	3.81	4000	R4300
V	BM-187-175-342-3	3:1	White	14.81	8.51	-	1.57	3.81	3000	R4300
V	BM-187-175-342-2	3:1	White	22.23	8.51	-	1.57	3.81	2000	R4300
V	BM-187-1-342	3:1	White	25.40	8.51	-	1.57	3.81	1000	R4300
V	M7-187-1-342	3:1	White	25.40	8.51	-	1.57	3.81	100	R6600
V	BM-187-1-342-YL	3:1	Yellow	25.40	8.51	-	1.57	3.81	1000	R4300
V	M7-187-1-342-YL	3:1	Yellow	25.40	8.51	-	1.57	3.81	100	R6600
V	BM-187-175-342-OR	3:1	Orange	44.45	8.51	-	1.57	3.81	1000	R4300
V	BM-187-175-342-RD	3:1	Red	44.45	8.51	-	1.57	3.81	1000	R4300
V	BM-187-175-342	3:1	White	44.45	8.51	-	1.57	3.81	1000	R4300
V	M7-187-175-342	3:1	White	44.45	8.51	-	1.57	3.81	100	R6600

Order references beginning with "B" indicate bulk rolls.

>>



## Wire & cable marking

### PermaSleeve heat-shrink sleeve markers (continued)

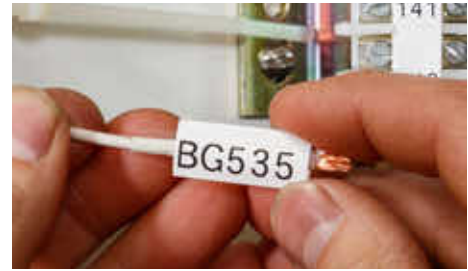
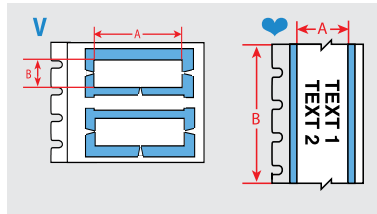

Diagram	Order Reference	Shrink Ratio	Colour	Sleeve Width A (mm)	Sleeve Height B (mm)	Sleeve Length B (mm)	Min. Wire Diameter (mm)	Max. Wire Diameter (mm)	Sleeves per roll	Printer Ribbon Series
B-342: Heat-shrink Polyolefin										
V	BM-187-175-342-YL	3:1	Yellow	44.45	8.51	-	1.57	3.81	1000	R4300
V	M7-187-175-342-YL	3:1	Yellow	44.45	8.51	-	1.57	3.81	100	R6600
♥	BM7C-250-342	3:1	White	-	11.15	15.24	2.39	5.46	1	R4300
V	BM-250-1-342	3:1	White	25.40	11.15	-	2.39	5.46	1000	R4300
V	M7-250-1-342	3:1	White	25.40	11.15	-	2.39	5.46	100	R6600
V	BM-250-1-342-YL	3:1	Yellow	25.40	11.15	-	2.39	5.46	1000	R4300
V	M7-250-1-342-YL	3:1	Yellow	25.40	11.15	-	2.39	5.46	100	R6600
V	BM-250-175-342	3:1	White	44.45	11.15	-	2.39	5.46	1000	R4300
V	M7-250-175-342	3:1	White	44.45	11.15	-	2.39	5.46	100	R6600
V	BM-250-175-342-YL	3:1	Yellow	44.45	11.15	-	2.39	5.46	1000	R4300
V	M7-250-175-342-YL	3:1	Yellow	44.45	11.15	-	2.39	5.46	100	R6600
♥	BM7C-375-342	3:1	White	-	16.38	15.24	3.18	8.13	1	R4300
V	BM-375-1-342-2	3:1	White	12.70	16.38	-	3.18	8.13	2000	R6600
V	BM-375-175-342-2	3:1	White	22.23	16.38	-	3.18	8.13	2000	R4300
V	BM-375-1-342	3:1	White	25.40	16.38	-	3.18	8.13	1000	R4300
V	M7-375-1-342	3:1	White	25.40	16.38	-	3.18	8.13	100	R6600
V	BM-375-1-342-YL	3:1	Yellow	25.40	16.38	-	3.18	8.13	1000	R6600
V	M7-375-1-342-YL	3:1	Yellow	25.40	16.38	-	3.18	8.13	100	R6600
V	BM-375-175-342	3:1	White	44.45	16.38	-	3.18	8.13	1000	R4300
V	M7-375-175-342	3:1	White	44.45	16.38	-	3.18	8.13	100	R6600
V	BM-375-175-342-YL	3:1	Yellow	44.45	16.38	-	3.18	8.13	1000	R4300
V	M7-375-175-342-YL	3:1	Yellow	44.45	16.38	-	3.18	8.13	100	R6600
♥	BM7C-500-342	3:1	White	-	21.62	15.24	4.75	11.43	1	R4300
V	BM-500-175-342-YL-3	3:1	Yellow	14.81	21.62	-	4.75	11.43	3000	R4300
V	BM-500-1-342	3:1	White	25.40	21.62	-	4.75	11.43	1000	R4300
V	M7-500-1-342	3:1	White	25.40	21.62	-	4.75	11.43	100	R6600
V	BM-500-1-342-YL	3:1	Yellow	25.40	21.62	-	4.75	11.43	1000	R4300
V	M7-500-1-342-YL	3:1	Yellow	25.40	21.62	-	4.75	11.43	100	R6600
V	BM-500-175-342	3:1	White	44.45	21.62	-	4.75	11.43	1000	R4300
V	BM-500-175-342-YL	3:1	Yellow	44.45	21.62	-	4.75	11.43	1000	R4300
V	M7-500-175-342-YL	3:1	Yellow	44.45	21.62	-	4.75	11.43	100	R6600
♥	BM7C-1000-342	3:1	White	-	42.16	15.24	8.46	24.13	1	R4300
V	M7-1000-1-342	3:1	White	25.40	42.16	-	8.46	24.13	50	R6600
V	BM-1000-175-342	3:1	White	44.45	42.16	-	8.46	24.13	500	R4300
V	M7-1000-175-342	3:1	White	44.45	42.16	-	8.46	24.13	50	R6600
V	M7-1000-1-342-YL	3:1	Yellow	25.40	42.34	-	8.46	24.13	50	R6600
V	M7-1000-175-342-YL	3:1	Yellow	44.45	42.34	-	8.46	24.13	50	R6600

Order references beginning with "B" indicate bulk rolls.

▶ See pages 49 - 51 for a detailed material index.

## Wire & cable marking



### PermaSleeve low smoke zero halogen wire marking sleeves, 2:1 shrink ratio

- These heat-shrink sleeves are the ultimate in marker identification, protection, durability and aesthetic appearance.
- These low smoke zero halogen wire marking sleeves offer outstanding fire safety properties and minimal smoke emission.
- Fast shrink rate saves time and costs during installation. Available as individual die-cut markers or continuous cut-to-length tubing.

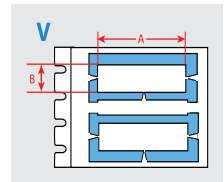

Sleeves are shown in order of sleeve height and per sleeve width.

Diagram	Order Reference	Shrink Ratio	Colour	Sleeve Width A (mm)	Sleeve Height B (mm)	Min. Wire Diameter (mm)	Max. Wire Diameter (mm)	Sleeves per roll	Printer Ribbon Series
B-7641: Heat-shrink Polyolefin									
V	BM-094-1-7641	2:1	White	25.40	4.62	1.19	2.03	2500	R6000HF R6600
V	M7-094-1-7641	2:1	White	25.40	4.62	1.19	2.03	100	R6000HF R6600
V	M7-094-1-7641-YL	2:1	Yellow	25.40	4.62	1.19	2.03	100	R6000HF R6600
V	M7-094-175-7641	2:1	White	44.45	4.62	1.19	2.03	100	R6000HF R6600
V	M7-094-175-7641-YL	2:1	Yellow	44.45	4.62	1.19	2.03	100	R6000HF R6600
V	BM-125-1-7641	2:1	White	25.40	5.97	1.57	2.79	1000	R6000HF R6600
V	M7-125-1-7641	2:1	White	25.40	5.97	1.57	2.79	100	R6000HF R6600
V	M7-125-1-7641-YL	2:1	Yellow	25.40	5.97	1.57	2.79	100	R6000HF R6600
V	BM-125-175-7641	2:1	White	44.45	5.97	1.57	2.79	1000	R6000HF R6600
V	M7-125-175-7641	2:1	White	44.45	5.97	1.57	2.79	100	R6000HF R6600
V	M7-125-175-7641-YL	2:1	Yellow	44.45	5.97	1.57	2.79	100	R6000HF R6600
V	BM-187-1-7641	2:1	White	25.40	8.51	2.39	3.81	1000	R6000HF R6600

Order references beginning with "B" indicate bulk rolls.

>>

## Wire & cable marking

### PermaSleeve low smoke zero halogen wire marking sleeves, 2:1 shrink ratio (continued)

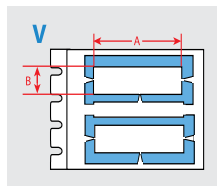

Sleeves are shown in order of sleeve height and per sleeve width.

Diagram	Order Reference	Shrink Ratio	Colour	Sleeve Width A (mm)	Sleeve Height B (mm)	Min. Wire Diameter (mm)	Max. Wire Diameter (mm)	Sleeves per roll	Printer Ribbon Series
B-7641: Heat-shrink Polyolefin									
V	M7-187-1-7641	2:1	White	25.40	8.51	2.39	3.81	100	R6000HF R6600
V	M7-187-1-7641-YL	2:1	Yellow	25.40	8.51	2.39	3.81	100	R6000HF R6600
V	BM-187-175-7641	2:1	White	44.45	8.51	2.39	3.81	1000	R6000HF R6600
V	M7-187-175-7641	2:1	White	44.45	8.51	2.39	3.81	100	R6000HF R6600
V	M7-187-175-7641-YL	2:1	Yellow	44.45	8.51	2.39	3.81	100	R6000HF R6600
V	BM-250-1-7641	2:1	White	25.40	11.15	3.18	5.46	1000	R6000HF R6600
V	M7-250-1-7641	2:1	White	25.40	11.15	3.18	5.46	100	R6000HF R6600
V	M7-250-1-7641-YL	2:1	Yellow	25.40	11.15	3.18	5.46	100	R6000HF R6600
V	M7-250-175-7641	2:1	White	44.45	11.15	3.18	5.46	100	R6000HF R6600
V	M7-250-175-7641-YL	2:1	Yellow	44.45	11.15	3.18	5.46	100	R6000HF R6600
V	BM-375-1-7641	2:1	White	25.40	16.38	4.78	8.13	1000	R6000HF R6600
V	M7-375-1-7641	2:1	White	25.40	16.38	4.78	8.13	100	R6000HF R6600
V	M7-375-1-7641-YL	2:1	Yellow	25.40	16.38	4.78	8.13	100	R6000HF R6600
V	BM-375-175-7641	2:1	White	44.45	16.38	4.78	8.13	1000	R6000HF R6600
V	M7-375-175-7641	2:1	White	44.45	16.38	4.78	8.13	100	R6000HF R6600
V	M7-375-175-7641-YL	2:1	Yellow	44.45	16.38	4.78	8.13	100	R6000HF R6600
V	M7-500-1-7641	2:1	White	25.40	21.62	6.35	11.43	100	R6000HF R6600
V	M7-500-1-7641-YL	2:1	Yellow	25.40	21.62	6.35	11.43	100	R6000HF R6600
V	M7-500-175-7641	2:1	White	44.45	21.62	6.35	11.43	100	R6000HF R6600
V	M7-500-175-7641-YL	2:1	Yellow	44.45	21.62	6.35	11.43	100	R6000HF R6600
V	M7-750-1-7641	2:1	White	25.40	31.75	9.53	17.78	75	R6000HF R6600
V	M7-750-1-7641-YL	2:1	Yellow	25.40	31.75	9.53	17.78	75	R6000HF R6600
V	M7-750-175-7641	2:1	White	44.45	31.75	9.53	17.78	75	R6000HF R6600
V	M7-750-175-7641-YL	2:1	Yellow	44.45	31.75	9.53	17.78	75	R6000HF R6600

Order references beginning with "B" indicate bulk rolls.

▶ See pages 49 - 51 for a detailed material index.



## Wire & cable marking



### Self-laminating labels

- Features a clear, non-printable area that wraps around the cable and serves as an overlaminate to the printed text.
- Offers superior resistance to abrasion, dirt, oils, solvents and water.

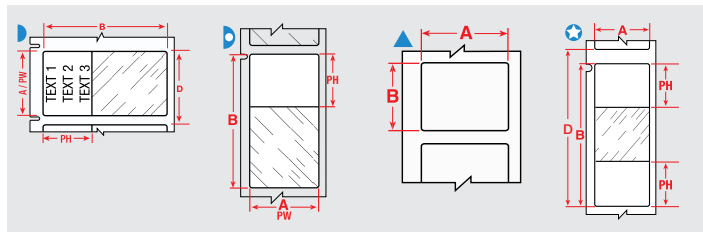

Diagram	Order Reference	Colour	Label Width A (mm)	Label Height B (mm)	Printable Area Width PW (mm)	Printable Area Height PH (mm)	Vertical Repeat D (mm)	Min. Wire Diameter (mm)	Max. Wire Diameter (mm)	Labels per Roll	Printer Ribbon Series
<b>B-417: Self-laminating Vinyl</b>											
▶	M7-11-417	White, Transparent	12.70	19.05	12.70	9.53	-	1.52	3.03	500	R4300
▶	M7-29-417	White, Transparent	12.70	38.10	12.70	12.70	-	2.03	4.04	500	R4300
▶	M7-96-417	White, Transparent	25.40	19.05	25.40	9.53	22.23	1.52	3.03	250	R4300
▶	M7-19-417	White, Transparent	25.40	25.40	25.40	9.53	-	1.52	3.03	250	R4300
▶	M7-103-417	White, Transparent	25.40	31.75	25.40	12.70	-	3.40	6.10	250	R4300
▶	M7-31-417	White, Transparent	25.40	38.10	25.40	12.70	-	4.00	8.10	250	R4300
▶	M7-21-417	White, Transparent	25.40	63.50	25.40	19.05	-	3.05	6.07	100	R4300
▶	M7-32-417	White, Transparent	38.10	38.10	38.10	12.70	-	2.03	4.04	250	R4300
▶	M7-109-417	White, Transparent	38.10	101.60	38.10	38.10	-	6.10	12.14	100	R4300
▶	M7-66-417	White, Transparent	49.23	80.00	49.23	25.40	83.57	4.06	8.08	100	R4300
<b>B-427: Self-laminating Vinyl</b>											
▶	M7-10-427	White, Transparent	6.35	19.05	6.35	9.53	9.53	2.00	3.00	750	R4300
▶	M7-28-427	White, Transparent	6.35	38.10	6.35	12.70	9.53	4.00	8.10	750	R4300
▶	M7-11-427	White, Transparent	12.70	19.05	12.70	9.53	15.88	2.00	3.00	500	R4300
▶	BM-11-427	White, Transparent	12.70	19.05	12.70	9.53	15.88	2.00	3.00	5000	R4300
▶	M7-17-427	White, Transparent	12.70	25.40	12.70	9.53	15.88	2.70	5.10	500	R4300
▶	BM-17-427	White, Transparent	12.70	25.40	12.70	9.53	15.88	2.70	5.10	5000	R4300
▶	M7-29-427	White, Transparent	12.70	38.10	12.70	12.70	15.88	4.00	8.10	500	R4300
▶	BM-29-427	White, Transparent	12.70	38.10	12.70	12.70	15.88	4.00	8.10	5000	R4300
▶	M7-18-427	White, Transparent	19.05	25.40	19.05	9.53	22.23	2.70	5.10	250	R4300
▶	BM-18-427	White, Transparent	19.05	25.40	19.05	9.53	22.23	2.70	5.10	2500	R4300
▶	M7-30-427	White, Transparent	19.05	38.10	19.05	12.70	22.23	4.00	8.10	250	R4300
▶	BM-30-427	White, Transparent	19.05	38.10	19.05	12.70	22.23	4.00	8.10	2500	R4300
▶	M7-30-427-BL	Blue, Transparent	19.05	38.10	19.05	12.70	22.23	4.00	8.10	250	R4300, R4400, R6700
▶	M7-30-427-PL	Purple, Transparent	19.05	38.10	19.05	12.70	22.23	4.00	8.10	250	R4300, R4400, R6700
▶	M7-30-427-RD	Red, Transparent	19.05	38.10	19.05	12.70	22.23	4.00	8.10	250	R4300, R4400, R6700
▶	M7-96-427	White, Transparent	25.40	19.05	25.40	9.53	22.23	2.00	3.00	250	R4300
▶	M7-19-427	White, Transparent	25.40	25.40	25.40	9.53	28.58	2.70	5.10	250	R4300
▶	BM-19-427	White, Transparent	25.40	25.40	25.40	9.53	28.58	2.70	5.10	2500	R4300

## Wire & cable marking

### Self-laminating labels (continued)

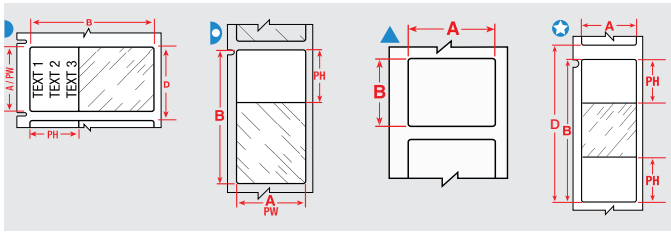

Diagram	Order Reference	Colour	Label Width A (mm)	Label Height B (mm)	Printable Area Width PW (mm)	Printable Area Height PH (mm)	Vertical Repeat D (mm)	Min. Wire Diameter (mm)	Max. Wire Diameter (mm)	Labels per Roll	Printer Ribbon Series
▶	M7-19-427-YL	Yellow, Transparent	25.40	25.40	25.40	9.53	28.58	2.70	5.10	250	R4300, R4400, R6700
▶	M7-103-427	White, Transparent	25.40	31.75	25.40	12.70	34.93	3.40	6.10	250	R4300
▶	M7-31-427-YL	Yellow, Transparent	25.40	38.10	25.40	12.70	28.58	4.00	8.10	250	R4300
▶	M7-31-427	White, Transparent	25.40	38.10	25.40	12.70	28.58	4.00	8.10	250	R4300
▶	BM-31-427	White, Transparent	25.40	38.10	25.40	12.70	28.58	4.00	8.10	2500	R4300
▶	M7-31-427-GN	Green, Transparent	25.40	38.10	25.40	12.70	28.58	4.00	8.10	250	R4300, R4400, R6700
▶	M7-31-427-RD	Red, Transparent	25.40	38.10	25.40	12.70	28.58	4.00	8.10	250	R4300, R4400, R6700
▶	M7-21-427	White, Transparent	25.40	63.50	25.40	19.05	66.68	6.70	14.20	100	R4300
▶	BM-21-427	White, Transparent	25.40	63.50	25.40	19.05	66.68	6.70	14.20	1000	R4300
▶	M7-21-427-YL	Yellow, Transparent	25.40	63.50	25.40	19.05	66.68	6.70	14.20	100	R4300, R4400, R6700
★	M7-64-427	White, Transparent	25.40	85.73	25.40	28.58	88.90	9.10	18.20	100	R4300
★	BM-64-427	White, Transparent	25.40	85.73	25.40	28.58	88.90	9.10	18.20	1000	R4300
▶	M7-23-427	White, Transparent	25.40	101.60	25.40	25.40	104.78	10.80	24.30	100	R4300
▶	BM-23-427	White, Transparent	25.40	101.60	25.40	25.40	104.78	10.80	24.30	1000	R4300
▲	M7-30-427-AW	White	38.10	19.05	-	-	22.23	4.00	8.00	250	R4300, R4400, R6700
▶	M7-104-427	White, Transparent	38.10	25.40	38.10	9.53	28.58	2.70	5.10	250	R4300
▶	M7-32-427	White, Transparent	38.10	38.10	38.10	12.70	41.28	4.00	8.10	250	R4300
▶	BM-32-427	White, Transparent	38.10	38.10	38.10	12.70	41.28	4.00	8.10	1000	R4300
▶	M7-32-427-YL	Yellow, Transparent	38.10	38.10	38.10	12.70	41.28	4.00	8.10	250	R4300, R4400, R6700
▶	M7-33-427-YL	Yellow, Transparent	38.10	101.60	38.10	25.40	104.78	10.80	24.30	100	R4300
▶	M7-33-427	White, Transparent	38.10	101.60	38.10	25.40	104.78	10.80	24.30	100	R4300
▶	BM-33-427	White, Transparent	38.10	101.60	38.10	25.40	104.78	10.80	24.30	500	R4300
▶	BM-109-427	White, Transparent	38.10	101.60	38.10	38.10	104.78	10.80	20.20	500	R4300
▶	M7-109-427	White, Transparent	38.10	101.60	38.10	38.10	104.78	10.80	20.20	100	R4300
▶	M7-34-427	White, Transparent	38.10	152.40	38.10	38.10	155.58	16.20	36.40	50	R4300
▶	BM-34-427	White, Transparent	38.10	152.40	38.10	38.10	155.58	16.20	36.40	500	R4300
▶	M7-88-427	White, Transparent	44.45	38.10	44.45	12.70	41.28	4.00	8.10	250	R4300
▶	M7-66-427	White, Transparent	49.23	80.00	49.23	25.40	83.57	8.50	17.40	100	R4300
▶	BM-107-427	White, Transparent	50.80	38.10	50.80	12.70	53.98	4.00	8.10	1000	R4300
▶	M7-107-427	White, Transparent	50.80	38.10	50.80	12.70	53.98	4.00	8.10	100	R4300
<b>B-642: Polyvinylfluoride</b>											
▶	M7-19-642	White, Transparent	25.40	25.40	25.40	9.53	28.58	3.00	5.05	250	R4300
▶	M7-31-642	White, Transparent	25.40	38.10	25.40	12.70	28.58	4.00	8.10	250	R4300, R6200
▶	M7-21-642	White, Transparent	25.40	63.50	25.40	19.05	66.68	6.70	14.20	100	R4300, R6200

Order references beginning with "B" indicate bulk rolls. \*Order references ending with "AW" indicate all white labels with no clear area.

## Wire & cable marking



### Wrap around labels

- These durable cloth wrap around labels are available with either an adhesive that allows the markers to be removed cleanly and reapplied if necessary (B-498) or with a permanent adhesive (B-437, B-499).
- A 3 mm overlap is recommended with these materials for an ideal, long lasting solution.

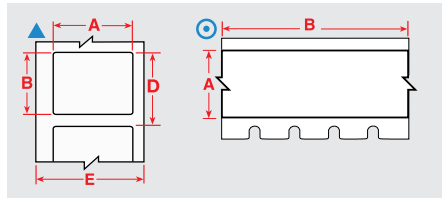

Diagram	Order Reference	Colour	Label Width A (mm)	Label Height B (mm)	Label Length B (m)	Vertical Repeat D (mm)	Max. Wire Diameter (mm)	Labels per Roll	Printer Ribbon Series
<b>B-472: Polyimide</b>									
⊙	M7C-1000-472-YL	Yellow	25.40	-	15.24	-	-	1	R4300, R6200
⊙	M7C-1000-472	White	25.40	-	15.24	-	-	1	R4300, R6200
▲	M7-17-472	White	25.40	12.70	-	15.88	-	500	R4300, R6200, R5000
⊙	M7C-1500-472-YL	Yellow	38.10	-	15.24	-	-	1	R4300, R6200
⊙	M7C-1500-472	White	38.10	-	15.24	-	-	1	R4300, R6200
▲	M7-30-472	White	38.10	19.05	-	22.23	-	250	R4300, R6200, R5000
⊙	M7C-2000-472-YL	Yellow	50.80	-	15.24	-	-	1	R4300, R6200
⊙	M7C-2000-472	White	50.80	-	15.24	-	-	1	R4300, R6200
<b>B-498: Vinyl Cloth</b>									
⊙	M7C-240-498	White	6.10	-	9.14	-	-	1	R6200
⊙	BM7C-240-498	White	6.10	-	83.82	-	-	1	R6200
▲	M7-10-498	White	6.35	19.05	-	9.53	4.55	750	R6200
⊙	M7C-318-498	White	8.08	-	9.14	-	-	1	R6200
⊙	M7C-375-498	White	9.53	-	9.14	-	-	1	R6200
⊙	BMC-375-498	White	9.53	-	83.82	-	-	1	R6200
▲	M7-16-498	White	9.53	25.40	-	12.70	6.06	500	R6200
⊙	M7C-500-498	White	12.70	-	9.14	-	-	1	R6200
▲	M7-7-498	White	12.70	12.70	-	15.88	3.03	500	R6200
▲	M7-11-498	White	12.70	19.05	-	15.88	4.55	500	R6200
▲	BM-11-498	White	12.70	19.05	-	15.88	4.55	5000	R6200
▲	BM-29-498	White	12.70	38.10	-	15.88	9.10	5000	R6200
▲	M7-18-498	White	19.05	25.40	-	22.23	6.06	250	R6200
▲	BM-18-498	White	19.05	25.40	-	22.23	6.06	2500	R6200
▲	M7-30-498	White	19.05	38.10	-	22.23	9.10	250	R6200
⊙	M7C-1000-498	White	25.40	-	9.14	-	-	1	R6200
▲	M7-17-498	White	25.40	12.70	-	15.88	6.06	500	R6200
▲	M7-19-498	White	25.40	25.40	-	28.58	6.06	250	R6200
▲	BM-19-498	White	25.40	25.40	-	28.58	6.06	2500	R6200
▲	M7-31-498	White	25.40	38.10	-	28.58	9.10	250	R6200
▲	M7-21-498	White	25.40	63.50	-	66.68	15.60	100	R6200
▲	M7-33-498	White	38.10	101.60	-	104.78	24.26	100	R6200
▲	M7-29-498	White	38.10	12.70	-	15.88	9.10	500	R6200
▲	M7-32-498	White	38.10	38.10	-	41.28	9.10	250	R6200
⊙	M7C-1900-498	White	48.26	-	9.14	-	-	1	R6200

Order references beginning with "B" indicate bulk rolls.

>>

▶ See pages 49 - 51 for a detailed material index.



## Wire & cable marking

### Wrap around labels (continued)

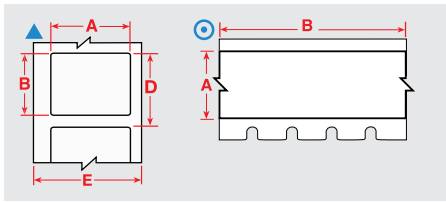

Diagram	Order Reference	Colour	Label Width A (mm)	Label Height B (mm)	Label Length B (m)	Vertical Repeat D (mm)	Max. Wire Diameter (mm)	Labels per Roll	Printer Ribbon Series
<b>B-499: Nylon Cloth</b>									
▲	M7-16-499	White	9.53	25.40	-	12.70	6.06	500	R4300
⊙	M7C-500-499	White	12.70	-	9.14	-	-	1	R4300, R6000HF, R6200
▲	M7-7-499	White	12.70	12.70	-	15.88	3.03	500	R4300
▲	M7-11-499	White	12.70	19.05	-	15.88	4.55	500	R4300
▲	BM-11-499	White	12.70	19.05	-	15.88	4.55	5000	R4300, R6000HF
▲	M7-29-499	White	12.70	38.10	-	15.88	9.10	500	R6200
▲	M7-67-499-YL	Yellow	15.00	9.00	-	-	-	750	R4300
▲	M7-41-499-YL	Yellow	16.00	5.00	-	-	-	750	R4300
▲	M7-18-499	White	19.05	25.40	-	22.23	6.06	250	R4300
▲	M7-30-499	White	19.05	38.10	-	22.23	9.10	250	R4300
▲	M7-84-499	White	22.86	12.70	-	15.88	6.06	500	R4300, R4500, R4900, R6000HF, R6200
⊙	M7C-1000-499	White	25.40	-	9.14	-	-	1	R4300, R6000HF, R6200
▲	M7-31-499	White	25.40	38.10	-	28.58	9.10	250	R4300, R6000HF, R6200
▲	M7-21-499	White	25.40	63.50	-	66.68	15.60	100	R4300, R4500, R4900, R6000HF, R6200
▲	M7-28-499	White	38.10	6.35	-	9.53	9.10	750	R4300, R4500, R4900, R6000HF, R6200
⊙	M7C-1900-499	White	48.26	-	9.14	-	-	1	R4300, R6000HF, R6200
▲	M7-78-499	White	48.26	25.40	-	28.58	10.00	250	R4300
▲	M7-81-499	White	48.26	6.35	-	9.53	10.00	750	R4300

Order references beginning with "B" indicate bulk rolls.



## Fibre optic labels/flags

These fibre optic flags allow more legible information to be printed on smaller diameter wires and permit you to handle and view labels without touching the wires.

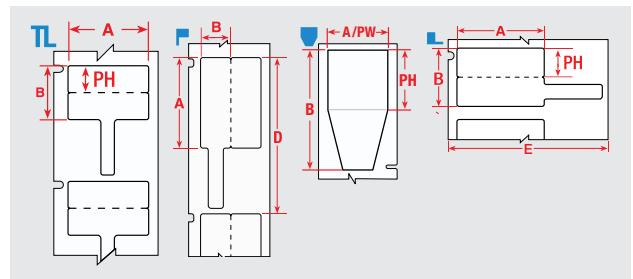

Diagram	Order Reference	Colour	Label Width A (mm)	Label Height B (mm)	Printable Area Height PH (mm)	Vertical Repeat D (mm)	Labels per Roll	Printer Ribbon Series
<b>B-425A: Polypropylene</b>								
TL	M7-1-425-FT	White	29.97	20.00	9.91	43.56	250	R4300
L	M7-1-425-FP	White	29.97	20.02	-	23.50	250	R4300
F	M7-2-425-FP	White	44.45	25.40	-	66.68	100	R4300 R6200 R6400
<b>B-483: Polyester</b>								
U	M7-214-483	White	25.40	50.80	-	-	250	R6000HF

# Electrical, voice/datacom identification

## Wire & cable marking



### RAPIDO plastic wiremarkers

- Yellow coated polyethylene tag suitable for durable wire marking for electrical devices and fibre installations.

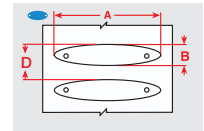

Diagram	Order Reference	Colour	Label Width A (mm)	Label Height B (mm)	Max. Lines of Text	Max. Characters per Line	Vertical Repeat D (mm)	Min. Wire Diameter (mm)	Max. Wire Diameter (mm)	Labels per Roll	Printer Ribbon Series
B-7599: Polyethylene											
	BM-1-7599-YL-R	Yellow	23.00	5.20	1	11	8.38	-	-	2500	R6200
	BM-2-7599-YL-R	Yellow	23.00	5.20	1	8	8.38	-	-	2500	R6200
	BM-3-7599-YL-R	Yellow	25.00	5.70	2	7	8.89	-	-	2500	R6200
	BM-4-7599-YL-R	Yellow	26.00	7.00	2	7	12.01	-	-	2500	R6200
	BM-5-7599-YL-R	Yellow	41.00	11.00	3	17	14.20	-	-	2500	R6200

Order references beginning with "B" indicate bulk rolls.



### Tear resistant cable markers

- These extremely tear resistant cable markers can be used for a variety of applications including identification of multiconductor cables, inventory and equipment.

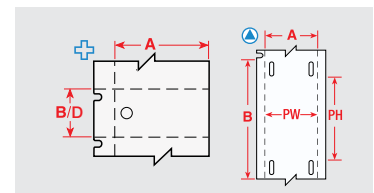

Diagram	Order Reference	Colour	Label Width A (mm)	Label Height B (mm)	Printable Area Width PW (mm)	Printable Area Height PH (mm)	Vertical Repeat D (mm)	Labels per Roll	Printer Ribbon Series
B-109: Polyethylene									
	BM-60-109	White	12.00	50.00	12.00	33.00	50.17	1000	R4300
	M7-12-109	White	19.05	76.20	12.45	52.07	76.20	100	R6200 R4300
	BM-12-109	White	19.05	76.20	12.45	52.07	76.20	1000	R6200 R4300
	M7-36-109	White	44.45	28.58	44.45	28.58	28.56	250	R6200 R4300

Order references beginning with "B" indicate bulk rolls.

### Coloured Nylon Ties

- Perfect for colour coded applications.

Order Reference	Colour	Width (mm)	Length (mm)	Quantity
196283	Black	3.50	200.00	100
196311	White	3.50	200.00	100
196352	Yellow	3.50	200.00	100
196349	Blue	3.60	200.00	100
196350	Green	3.60	200.00	100
196351	Red	3.60	200.00	100



## Wire & cable marking



### B-7598 Polyester cable tag

The B-7598 polyester tag is a general identification tag for cables exposed to extreme conditions. It requires cable ties to apply to cables with various diameters. Common applications for this cable tag material are:

- Identification of multi-conductor cables
- Identification of cables in mobile phone towers
- Identification of datacom or telecom cables in general
- General cable identification that must be extremely resistant

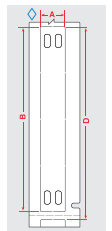

Diagram	Order Reference	Colour	Label Width A (mm)	Label Height B (mm)	Vertical Repeat D (mm)	Labels per Roll	Printer Ribbon Series
B-7598: Polyester							
◇	BM-10X60-7598-BK	Black	10.00	60.00	65.09	500	R4400-WT
◇	BM-10X60-7598-BL	Blue	10.00	60.00	65.09	500	R6000HF
◇	BM-10X60-7598-GN	Green	10.00	60.00	65.09	500	R6000HF
◇	BM-10X60-7598-RD	Red	10.00	60.00	65.09	500	R6000HF
◇	BM-10X60-7598-SV	Silver	10.00	60.00	65.09	500	R6000HF
◇	BM-10X60-7598-WT	White	10.00	60.00	65.09	500	R6000HF
◇	BM-10X60-7598-YL	Yellow	10.00	60.00	65.09	500	R6000HF
◇	BM-10X75-7598-BK	Black	10.00	75.00	80.43	250	R4400-WT
◇	BM-10X75-7598-BL	Blue	10.00	75.00	80.43	250	R6000HF
◇	BM-10X75-7598-GN	Green	10.00	75.00	80.43	250	R6000HF
◇	BM-10X75-7598-RD	Red	10.00	75.00	80.43	250	R6000HF
◇	BM-10X75-7598-SV	Silver	10.00	75.00	80.43	250	R6000HF
◇	BM-10X75-7598-WT	White	10.00	75.00	80.43	250	R6000HF
◇	BM-10X75-7598-YL	Yellow	10.00	75.00	80.43	250	R6000HF
◇	BM-15X75-7598-BK	Black	15.00	75.00	80.43	250	R4400-WT
◇	BM-15X75-7598-BL	Blue	15.00	75.00	80.43	250	R6000HF
◇	BM-15X75-7598-GN	Green	15.00	75.00	80.43	250	R6000HF
◇	BM-15X75-7598-RD	Red	15.00	75.00	80.43	250	R6000HF
◇	BM-15X75-7598-SV	Silver	15.00	75.00	80.43	250	R6000HF
◇	BM-15X75-7598-WT	White	15.00	75.00	80.43	250	R6000HF
◇	BM-15X75-7598-YL	Yellow	15.00	75.00	80.43	250	R6000HF
◇	BM-25X75-7598-BK	Black	25.00	75.00	80.43	250	R4400-WT
◇	BM-25X75-7598-BL	Blue	25.00	75.00	80.43	250	R6000HF
◇	BM-25X75-7598-GN	Green	25.00	75.00	80.43	250	R6000HF
◇	BM-25X75-7598-RD	Red	25.00	75.00	80.43	250	R6000HF
◇	BM-25X75-7598-SV	Silver	25.00	75.00	80.43	250	R6000HF
◇	BM-25X75-7598-WT	White	25.00	75.00	80.43	250	R6000HF
◇	BM-25X75-7598-YL	Yellow	25.00	75.00	80.43	250	R6000HF

Order references beginning with "B" indicate bulk rolls.

▶ See pages 49 - 51 for a detailed material index.



## Wire & cable marking

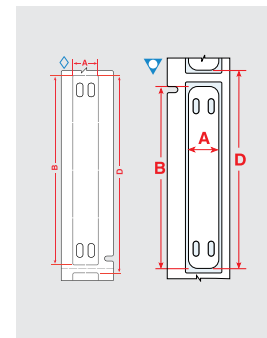

### B-7643 Halogen-free cable tag

- These cable markers are made of halogen-free polyurethane material.
- The markers are tough, imperishable and with a very high degree of mark permanence in almost any environment.

Diagram	Order Reference	Colour	Label Width A (mm)	Label Height B (mm)	Vertical Repeat D (mm)	Labels per Roll	Printer Ribbon Series
B-7643: Thermoplastic Polyether Polyurethane							
▽	BM-10x60-7643-WT-L	White	10.00	60.00	65.88	250	R6000HF
▽	BM-10x60-7643-YL-L	Yellow	10.00	60.00	65.88	250	R6000HF
▽	BM-10x75-7643-WT-L	White	10.00	75.00	81.17	250	R6000HF
▽	BM-10x75-7643-YL-L	Yellow	10.00	75.00	81.17	250	R6000HF
◇	BM-15x75-7643-BK	Black	15.00	75.00	80.43	250	R4400-WT
◇	BM-15x75-7643-BL	Blue	15.00	75.00	80.43	250	R6000HF
◇	BM-15x75-7643-GN	Green	15.00	75.00	80.43	250	R6000HF
◇	BM-15x75-7643-OR	Orange	15.00	75.00	80.43	250	R6000HF
◇	BM-15x75-7643-RD	Red	15.00	75.00	80.43	250	R6000HF
◇	BM-15x75-7643-WT	White	15.00	75.00	80.43	250	R6000HF
◇	BM-15x75-7643-YL	Yellow	15.00	75.00	80.43	250	R6000HF
◇	BM-25x75-7643-BK	Black	25.00	75.00	80.43	250	R4400-WT
◇	BM-25x75-7643-BL	Blue	25.00	75.00	80.43	250	R6000HF
◇	BM-25x75-7643-GN	Green	25.00	75.00	80.43	250	R6000HF
◇	BM-25x75-7643-OR	Orange	25.00	75.00	80.43	250	R6000HF
◇	BM-25x75-7643-RD	Red	25.00	75.00	80.43	250	R6000HF
◇	BM-25x75-7643-WT	White	25.00	75.00	80.43	250	R6000HF
▽	BM-25x75-7643-WT-L	White	25.00	75.00	82.55	250	R6000HF
◇	BM-25x75-7643-YL	Yellow	25.00	75.00	80.43	250	R6000HF
▽	BM-25x75-7643-YL-L	Yellow	25.00	75.00	82.55	250	R6000HF
◇	BM7-10x60-7643-BK	Black	10.00	60.00	65.09	250	R4400
◇	BM7-10x60-7643-BL	Blue	10.00	60.00	65.09	250	R6000HF
◇	BM7-10x60-7643-GN	Green	10.00	60.00	65.09	250	R6000HF
◇	BM7-10x60-7643-OR	Orange	10.00	60.00	65.09	250	R6000HF
◇	BM7-10x60-7643-RD	Red	10.00	60.00	65.09	250	R6000HF
◇	BM7-10x60-7643-WT	White	10.00	60.00	65.09	250	R6000HF
◇	BM7-10x60-7643-YL	Yellow	10.00	60.00	65.09	250	R6000HF
◇	BM7-10x75-7643-BK	Black	10.00	75.00	80.43	250	R4400-WT
◇	BM7-10x75-7643-BL	Blue	10.00	75.00	80.43	250	R6000HF
◇	BM7-10x75-7643-GN	Green	10.00	75.00	80.43	250	R6000HF
◇	BM7-10x75-7643-OR	Orange	10.00	75.00	80.43	250	R6000HF
◇	BM7-10x75-7643-RD	Red	10.00	75.00	80.43	250	R6000HF
◇	BM7-10x75-7643-WT	White	10.00	75.00	80.43	250	R6000HF
◇	BM7-10x75-7643-YL	Yellow	10.00	75.00	80.43	250	R6000HF

Order references beginning with "B" indicate bulk rolls.

## Wire & cable marking

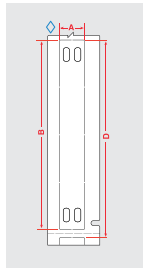

### B-348 Mass transit tag

- The B-348 Mass Transit Tag complies with minimal smoke and halogen emission requirements of the most strict underground norms for mass transit vehicles.
- Printable both on-site and in the field, the tag is a practical solution for mass transit manufacturers to identify thick cables and cable bundles.

Diagram	Order Reference	Colour	Label Width A (mm)	Label Height B (mm)	Vertical Repeat D (mm)	Labels per Roll	Printer Ribbon Series
B-348: Polyolefin							
◇	BM-10x60-348-WT	White	10.00	60.00	65.09	250	R6000HF
◇	BM-10x60-348-YL	Yellow	10.00	60.00	65.09	250	R6000HF
◇	BM-10x75-348-WT	White	10.00	75.00	80.43	250	R6000HF
◇	BM-10x75-348-YL	Yellow	10.00	75.00	80.43	250	R6000HF
◇	BM-15x75-348-WT	White	15.00	75.00	80.43	250	R6000HF
◇	BM-15x75-348-YL	Yellow	15.00	75.00	80.43	250	R6000HF
◇	BM-25x75-348-WT	White	25.00	75.00	80.43	250	R6000HF
◇	BM-25x75-348-YL	Yellow	25.00	75.00	80.43	250	R6000HF



### BradyGrip™ print-on hook material

BradyGrip™ Print-on Hook Material is a one-of-a-kind solution that allows identification to be easily printed and placed on bundles. A grippy backing makes it easy to reposition or remove, so no need for costly rework. Just print on and place - it's that simple.

- Maximises your uptime with faster, printable ID for cable bundles.
- Apply, reposition and remove with exclusive, print-and-place material.
- Offers a non-damaging alternative to nylon cable ties.
- Customise labels to fit big or small jobs by printing on different-width material.

Diagram	Order Reference	Colour	Label Width A (mm)	Label Length B (m)
B-414: Polyester				
⊙	M7C-250-414	White	6.35	6.10 m
⊙	M7C-500-414	White	12.70	6.10 m
⊙	M7C-750-414	White	19.05	6.10 m
⊙	M7C-1000-414	White	25.40	6.10 m
⊙	M7C-1500-414	White	38.10	6.10 m

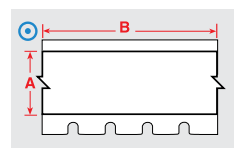

▶ See pages 49 - 51 for a detailed material index.

## Wire & cable marking



### DuraSleeve inserts

- Brady DuraSleeve printable inserts create a durable legend.
- Tags and inserts easily slide into the clear carriers.
- The legend can be changed before or after termination.

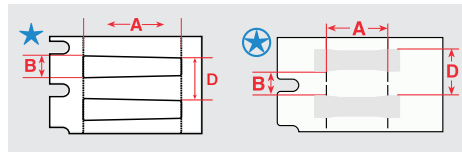

Diagram	Order Reference	Colour	Label Width A (mm)	Label Height B (mm)	Vertical Repeat D (mm)	Labels per Roll	Printer Ribbon Series
<b>B-7696: Vinyl</b>							
★	M7-10x4.4-7696-WT	White	10.00	4.40	7.58	500	R6000HF
★	M7-10x4.4-7696-YL	Yellow	10.00	4.40	7.58	500	R6000HF
★	BM-10x4.4-7696-WT	White	10.00	4.40	7.56	2500	R6000HF
★	BM-10x4.4-7696-YL	Yellow	10.00	4.40	7.56	2500	R6000HF
★	M7-12x4.4-7696-WT	White	12.00	4.40	7.58	500	R6000HF
★	M7-12x4.4-7696-YL	Yellow	12.00	4.40	7.58	500	R6000HF
★	BM-12x4.4-7696-WT	White	12.00	4.40	7.56	2500	R6000HF
★	BM-12x4.4-7696-YL	Yellow	12.00	4.40	7.56	2500	R6000HF
★	M7-16x4.4-7696-WT	White	16.00	4.40	7.58	500	R6000HF
★	BM-16x4.4-7696-WT	White	16.00	4.40	7.56	2500	R6000HF
★	BM-16x4.4-7696-YL	Yellow	16.00	4.40	7.56	5000	R6000HF
★	M7-23x4.4-7696-WT	White	23.00	4.40	7.58	500	R6000HF
★	M7-23x4.4-7696-YL	Yellow	23.00	4.40	7.58	500	R6000HF
★	BM-23x4.4-7696-WT	White	23.00	4.40	7.56	2500	R6000HF
★	BM-23x4.4-7696-YL	Yellow	23.00	4.40	7.56	2500	R6000HF
★	M7-30x4.4-7696-WT	White	30.00	4.40	7.58	500	R6000HF
★	BM-30x4.4-7696-WT	White	30.00	4.40	7.56	2500	R6000HF
★	BM-30x4.4-7696-YL	Yellow	30.00	4.40	7.56	5000	R6000HF
<b>B-7697: Polyester</b>							
★	M7-10x4.4-7697-WT	White	10.00	4.40	7.58	500	R4300, R6200
★	M7-12x4.4-7697-WT	White	12.00	4.40	7.58	500	R4300, R6200
★	M7-16x4.4-7697-WT	White	16.00	4.40	7.58	500	R4300, R6200
★	M7-23x4.4-7697-WT	White	23.00	4.40	7.58	500	R4300, R6200
★	M7-30x4.4-7697-WT	White	30.63	4.40	7.58	500	R4300, R6200

Order references beginning with "B" indicate bulk rolls.

### DuraSleeve tag carrier

DuraSleeve tag carriers are produced in transparent PVC. The special shape of the carrier allows it to adapt to cables of various diameters. There are several sizes of carriers which cater for cables with external diameters from 1.30 mm up to 15 mm.

- Temperature range: -40 °C to 60 °C
- Material: PVC

Please contact your local Brady representative to identify and select the most appropriate carrier for your individual application.



Order Reference	Colour	Carrier Length	Min. Wire Diameter (mm)	Max. Wire Diameter (mm)	Carriers per Box
<b>Polyvinylchloride</b>					
DMC-1.5/2.5-10	Transparent	10.00	1.50	2.50	1000
DMC-2/4-10	Transparent	10.00	2.00	4.00	1000
DMC-4/7-10	Transparent	10.00	4.00	7.00	500
DMC-6/10-10	Transparent	10.00	6.00	10.00	500
DMC-10/14-10	Transparent	10.00	10.00	14.00	200
DMC-1.5/2.5-12	Transparent	12.00	1.50	2.50	1000
DMC-2/4-12	Transparent	12.00	2.00	4.00	1000
DMC-4/7-12	Transparent	12.00	4.00	7.00	500
DMC-6/10-12	Transparent	12.00	6.00	10.00	500
DMC-10/14-12	Transparent	12.00	10.00	14.00	200
DMC-10/14-16	Transparent	16.00	10.00	14.00	200
DMC-1.5/2.5-16	Transparent	16.00	1.50	2.50	1000

Order Reference	Colour	Carrier Length	Min. Wire Diameter (mm)	Max. Wire Diameter (mm)	Carriers per Box
DMC-2/4-16	Transparent	16.00	2.00	4.00	1000
DMC-4/7-16	Transparent	16.00	4.00	7.00	500
DMC-6/10-16	Transparent	16.00	6.00	10.00	500
DMC-1.5/2.5-23	Transparent	23.00	1.50	2.50	500
DMC-2/4-23	Transparent	23.00	2.00	4.00	500
DMC-4/7-23	Transparent	23.00	4.00	7.00	500
DMC-6/10-23	Transparent	23.00	6.00	10.00	200
DMC-10/14-23	Transparent	23.00	10.00	14.00	200
DMC-1.5/2.5-30	Transparent	30.00	1.50	2.50	500
DMC-2/4-30	Transparent	30.00	2.00	4.00	500
DMC-4/7-30	Transparent	30.00	4.00	7.00	200
DMC-6/10-30	Transparent	30.00	6.00	10.00	200
DMC-10/14-30	Transparent	30.00	10.00	14.00	200



## Component & equipment marking

### EPREP: Engraved Plate REplacement Labels

Brady EPREP labels are innovative labels specifically designed to replace engraved and plotted plates for identification of electrical components, electrical cabinets, push buttons, patch panels etc.

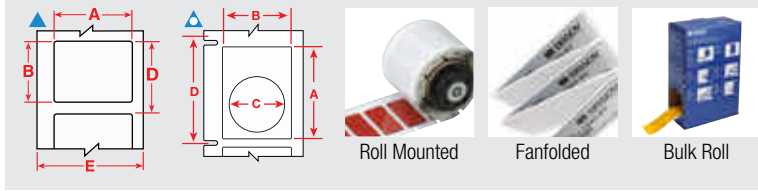

Diagram	Order Reference	Colour	Label Width A (mm)	Label Height B (mm)	Hole Diameter C (mm)	Vertical Repeat D (mm)	Labels per Roll	Layout	Printer Ribbon Series
B-7593: Polyethylene Foam Laminate Polyester									
▲	M7-1-7593-SL	Silver	27.00	7.95	-	11.18	250		R6000HF
▲	M7-1-7593-WT	White	27.00	7.95	-	11.18	250		R6000HF
▲	M7-2-7593-SL	Silver	27.00	12.45	-	15.63	250		R6000HF
▲	M7-2-7593-WT	White	27.00	12.45	-	15.63	250		R6000HF
▲	M7-3-7593-SL	Silver	27.00	15.00	-	18.14	150		R6000HF
▲	M7-3-7593-WT	White	27.00	15.00	-	18.14	150		R6000HF
▲	M7-4-7593-SL	Silver	27.00	18.00	-	21.25	150		R6000HF
▲	M7-4-7593-WT	White	27.00	18.00	-	21.25	150		R6000HF
△	M7-5-7593-BK	Black	30.00	40.00	24.00	50.80	100	Fan-folded	R4400-WT
△	M7-5-7593-GN	Green	30.00	40.00	24.00	50.80	100	Fan-folded	R6000HF
△	M7-5-7593-RD	Red	30.00	40.00	24.00	50.80	100	Fan-folded	R6000HF
△	M7-5-7593-SL	Silver	30.00	40.00	24.00	50.80	100	Fan-folded	R6000HF
△	M7-5-7593-WT	White	30.00	40.00	24.00	50.80	100	Fan-folded	R6000HF
△	M7-5-7593-YL	Yellow	30.00	40.00	24.00	50.80	100	Fan-folded	R6000HF
▲	M7-7-7593-SL	Silver	35.00	18.00	-	21.49	100		R6000HF
▲	M7-7-7593-WT	White	35.00	18.00	-	21.49	100		R6000HF
▲	M7-7-7593-YL	Yellow	35.00	18.00	-	21.49	100		R6000HF
▲	M7-6-7593-BK	Black	45.00	15.00	-	40.37	100	Fan-folded	R4400-WT
▲	M7-6-7593-RD	Red	45.00	15.00	-	40.37	100	Fan-folded	R6000HF
▲	BM-06-7593-SL	Silver	45.00	15.00	-	18.26	500		R6000HF
▲	BM-06-7593-WT	White	45.00	15.00	-	18.26	500		R6000HF
▲	M7-6-7593-YL	Yellow	45.00	15.00	-	40.37	100	Fan-folded	R6000HF
▲	M7-8-7593-SL	Silver	48.00	19.00	-	22.46	125		R6000HF
▲	M7-8-7593-WT	White	48.00	19.00	-	22.46	125		R6000HF

Order references beginning with "B" indicate bulk rolls.

### Terminal block markers

Repositionable vinyl cloth marker with a firm adhesive offering excellent holding power, but can be easily removed and reapplied.

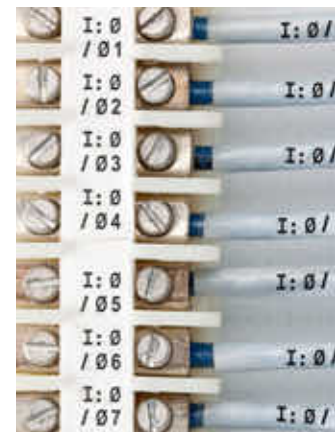
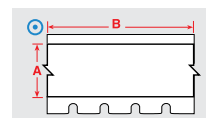

Diagram	Order Reference	Colour	Label Width A (mm)	Label Length B (m)	Labels per Roll	Printer Ribbon Series
B-498: Vinyl Cloth						
⊙	M7C-240-498	White	6.10	9.14	1	R6200
⊙	M7C-318-498	White	8.08	9.14	1	R6200
⊙	M7C-375-498	White	9.53	9.14	1	R6200
⊙	M7C-500-498	White	12.70	9.14	1	R6200
⊙	BM7C-240-498	White	6.10	83.82	1	R6200
⊙	BMC-375-498	White	9.53	83.82	1	R6200

Order references beginning with "B" indicate bulk rolls.

▶ See pages 49 - 51 for a detailed material index.

## Component & equipment marking



### Punch block and patch panel labels

- Create a fully-formatted serialised punch block label to fit your equipment.
- Label your ports, jack and outlets with adhesive labels or slide-in strips.

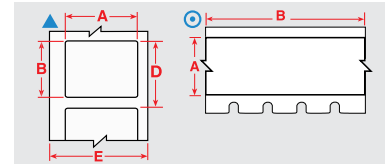

Diagram	Order Reference	Colour	Label Width A (mm)	Label Height B (mm)	Label Length B (m)	Vertical Repeat D (mm)	Labels per Roll	Printer Ribbon Series
<b>B-412: Polypropylene</b>								
⊙	M7C-230-412	White	5.84	-	15.24	-	1	R6200 R4300
⊙	M7C-375-412	White	9.53	-	15.24	-	1	R6200 R4300
⊙	M7C-475-412	White	12.07	-	15.24	-	1	R6200 R4300
⊙	M7C-785-412	White	19.94	-	15.24	-	1	R6200 R4300
<b>B-422: Polyester</b>								
▲	M7-45-422	White	38.10	9.53	-	12.70	500	R6000HF
▲	M7-30-422	White	38.10	19.05	-	22.23	250	R6000HF
⊙	M7C-375-422	White	9.53	-	15.24	-	1	R6000HF
⊙	M7C-475-422	White	12.07	-	15.24	-	1	R6000HF
⊙	M7C-500-422	White	12.70	-	15.24	-	1	R6000HF
⊙	M7C-625-422	White	15.88	-	15.24	-	1	R6000HF
⊙	M7C-1000-422	White	25.40	-	15.24	-	1	R6000HF
<b>B-423: Polyester</b>								
▲	M7-1-423	White	6.35	6.35	-	9.53	750	R6000HF
▲	M7-3-423	White	9.53	9.53	-	12.70	500	R6000HF
▲	M7-4-423	White	10.16	10.16	-	13.34	500	R6000HF
▲	M7-7-423	White	12.70	12.70	-	15.88	500	R6000HF
▲	M7-6-423	White	12.70	6.99	-	10.16	750	R6000HF
▲	M7-5-423	White	12.70	5.08	-	8.26	750	R6000HF
▲	BM-7-423	White	12.70	12.70	-	15.88	5000	R6000HF
▲	M7-9-423	White	16.51	5.08	-	8.26	750	R6000HF
▲	M7-10-423	White	19.05	6.35	-	9.53	750	R6000HF
▲	M7-13-423	White	22.86	6.35	-	9.53	750	R6000HF
▲	M7-19-423	White	25.40	25.40	-	28.58	250	R6000HF
▲	M7-17-423	White	25.40	12.70	-	15.88	500	R6000HF
▲	M7-16-423	White	25.40	9.53	-	12.70	500	R6000HF
▲	M7-15-423	White	25.40	6.99	-	10.16	750	R6000HF
▲	M7-14-423	White	25.40	4.75	-	8.26	750	R6000HF
▲	BM-17-423	White	25.40	12.70	-	15.88	5000	R6000HF
▲	BM-16-423	White	25.40	9.53	-	12.70	5000	R6000HF
▲	BM-19-423	White	25.40	25.40	-	28.58	2500	R6000HF
▲	M7-25-423	White	31.75	6.35	-	9.53	750	R6000HF
▲	M7-32-423	White	38.10	38.10	-	41.28	250	R6000HF
▲	M7-31-423	White	38.10	25.40	-	28.58	250	R6000HF
▲	M7-29-423	White	38.10	12.70	-	15.88	500	R6000HF
▲	M7-28-423	White	38.10	6.35	-	9.53	750	R6000HF
▲	M7-27-423	White	38.10	3.18	-	6.35	750	R6000HF
▲	BM-29-423	White	38.10	12.70	-	15.88	5000	R6000HF

Order references beginning with "B" indicate bulk rolls.

>>

▶ See pages 49 - 51 for a detailed material index.

## Component & equipment marking

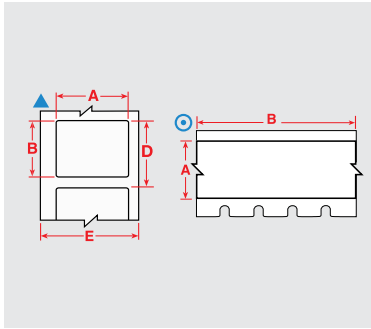

## Punch block and patch panel labels (continued)

Diagram	Order Reference	Colour	Label Width A (mm)	Label Height B (mm)	Label Length B (m)	Vertical Repeat D (mm)	Labels per Roll	Printer Ribbon Series
	M7C-500-423	White	12.70	-	15.24	-	1	R6000HF
<b>B-428: Metallised Polyester</b>								
	M7-17-428	Light Grey	25.40	12.70	-	15.88	500	R4300
	M7-15-428	Light Grey	25.40	6.99	-	10.16	750	R4300
	BM-17-428	Light Grey	25.40	12.70	-	15.88	5000	R4300
	M7-29-428	Light Grey	38.10	12.70	-	15.88	500	R4300
	M7C-500-428	Light Grey	12.70	-	15.24	-	1	R4300
<b>B-430: Polyester</b>								
	M7-71-430	Transparent	8.89	5.08	-	9.53	750	R6000HF
	M7-17-430	Transparent	25.40	12.70	-	15.88	500	R6000HF
	M7-16-430	Transparent	25.40	9.53	-	12.70	500	R6000HF
	M7-45-430	Transparent	38.10	9.53	-	12.70	500	R6000HF
	M7C-375-430	Transparent	9.53	-	15.24	-	1	R6000HF
	M7C-500-430	Transparent	12.70	-	15.24	-	1	R6000HF
	M7C-1000-430	Transparent	25.40	-	15.24	-	1	R6000HF
<b>B-483A: Polyester</b>								
	M7-19-483	White	25.40	25.40	-	28.58	250	R6000HF
	M7-17-483	White	25.40	12.70	-	15.88	500	R6000HF
	M7-16-483	White	25.40	9.53	-	12.70	500	R6000HF
	M7-65-483	White	34.93	25.40	-	28.58	250	R6000HF
	M7-31-483	White	38.10	25.40	-	28.58	250	R6000HF
	M7-30-483	White	38.10	19.05	-	22.23	250	R6000HF
	M7-29-483	White	38.10	12.70	-	15.88	500	R6000HF
	M7C-500-483	White	12.70	-	15.24	-	1	R6000HF
	M7C-1000-483	White	25.40	-	15.24	-	1	R6000HF

Order references beginning with "B" indicate bulk rolls.

## Workstation labels

A variety of durable and resistant materials to label your workstation.

Diagram	Order Reference	Colour	Label Width A (mm)	Label Height B (mm)	Vertical Repeat D (mm)	Labels per Roll	For Data Cables Sized to Fit	Printer Ribbon Series
<b>B-412: Polypropylene</b>								
	M7-40-412	White	49.23	9.53	9.53	750	DesiStrip	R6200 R4300
	BM-40-412	White	49.23	9.53	9.53	5000		R6200 R4300
<b>B-422: Polyester</b>								
	M7-45-422	White	38.10	9.53	12.70	500	Location Identification	R6000HF
<b>B-430: Polyester</b>								
	M7-71-430	Transparent	8.89	5.08	9.53	750	Faceplates & Outlets	R6000HF
	M7-17-430	Transparent	25.40	12.70	15.88	500	1-4 Outlet Faceplates Location Identification	R6000HF
	M7-16-430	Transparent	25.40	9.53	12.70	500		R6000HF
	M7-45-430	Transparent	38.10	9.53	12.70	500	Location Identification 1-4 Outlet Faceplates	R6000HF

Order references beginning with "B" indicate bulk rolls.

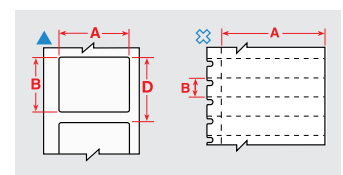



## Asset & component marking



## Rating and name plate labels

Choose from several materials with aggressive adhesives for use in commercial/industrial applications, including low surface energy and textured surfaces.

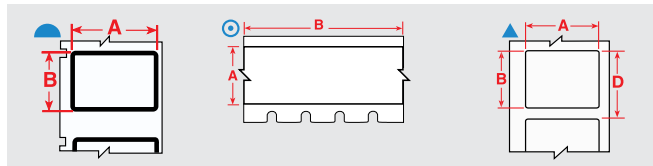

## For rough surfaces

Diagram	Order Reference	Colour	Label Width A (mm)	Label Height B (mm)	Label Length B (m)	Vertical Repeat D (mm)	Labels per Roll	Printer Ribbon Series
<b>B-483A: Polyester</b>								
▲	M7-61-483	White	12.70	50.80	-	53.98	100	R6000HF
▲	M7-20-483	White	25.40	50.80	-	53.98	100	R6000HF
▲	M7-19-483	White	25.40	25.40	-	28.58	250	R6000HF
▲	M7-17-483	White	25.40	12.70	-	15.88	500	R6000HF
▲	M7-16-483	White	25.40	9.53	-	12.70	500	R6000HF
▲	M7-65-483	White	34.93	25.40	-	28.58	250	R6000HF
▲	M7-31-483	White	38.10	25.40	-	28.58	250	R6000HF
▲	M7-30-483	White	38.10	19.05	-	22.23	250	R6000HF
▲	M7-29-483	White	38.10	12.70	-	15.88	500	R6000HF
▲	M7-37-483	White	76.20	48.26	-	79.38	100	R6000HF
▲	M7-38-483	White	101.60	48.26	-	104.78	100	R6000HF
▲	M7-23-483	White	101.60	25.40	-	104.78	100	R6000HF
⊙	M7C-500-483	White	12.70	-	15.24	-	1	R6000HF
⊙	M7C-1000-483	White	25.40	-	15.24	-	1	R6000HF
⊙	M7C-1900-483	White	50.80	-	15.24	-	1	R6000HF
<b>B-486B: Metallised Polyester</b>								
▲	M7-20-486	Light Grey	25.40	50.80	-	53.98	100	R4300
▲	M7-17-486	Light Grey	25.40	12.70	-	15.88	500	R4300
▲	M7-30-486	Light Grey	38.10	19.05	-	22.23	250	R4300
▲	M7-29-486	Light Grey	38.10	12.70	-	15.88	500	R6200
▲	M7-37-486	Light Grey	76.20	48.26	-	79.38	100	R4300
<b>B-489A: Polyester</b>								
▲	M7-17-489	White	25.40	12.70	-	15.88	500	R4300
▲	M7-32-489	White	38.10	38.10	-	41.28	250	R6200
▲	M7-29-489	White	38.10	12.70	-	15.88	500	R4300
▲	M7-38-489	White	101.60	48.26	-	104.78	100	R6200

## For low energy and textured surfaces

Diagram	Order Reference	Colour	Label Width A (mm)	Label Height B (mm)	Label Length B (m)	Vertical Repeat D (mm)	Labels per Roll	Printer Ribbon Series
<b>B-422: Polyester</b>								
▲	M7-45-422	White	38.10	9.53	-	12.70	500	R6000HF
▲	M7-30-422	White	38.10	19.05	-	22.23	250	R6000HF
▲	BM-20-422	White	50.80	25.40	-	53.98	1000	R6000HF
▲	M7-37-422	White	76.20	48.26	-	79.38	100	R6000HF
⊙	M7C-375-422	White	9.53	-	15.24	-	1	R6000HF
⊙	M7C-475-422	White	12.07	-	15.24	-	1	R6000HF
⊙	M7C-500-422	White	12.70	-	15.24	-	1	R6000HF
⊙	M7C-625-422	White	15.88	-	15.24	-	1	R6000HF
⊙	M7C-1000-422	White	25.40	-	15.24	-	1	R6000HF
⊙	M7C-1900-422	White	50.80	-	15.24	-	1	R6000HF
<b>B-435: Metallised Polyester</b>								
▲	M7-20-435	Silver	25.40	50.80	-	-	100	R6000HF
▲	M7-17-435	Silver	25.40	12.70	-	15.88	500	R6000HF
▲	M7-31-435	Silver	45.72	25.40	-	28.58	250	R6000HF
▲	M7-30-435	Silver	45.72	19.05	-	22.23	250	R6000HF
▲	M7-37-435	Silver	48.26	76.20	-	79.38	100	R6000HF

Order references beginning with "B" indicate bulk rolls.

▶ See pages 49 - 51 for a detailed material index.

## Asset & component marking

### Rating and name plate labels (continued)

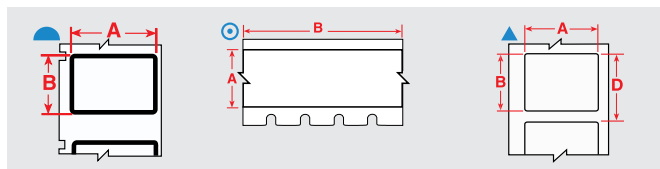

### For low energy and textured surfaces (continued)

Diagram	Order Reference	Colour	Label Width A (mm)	Label Height B (mm)	Label Length B (m)	Vertical Repeat D (mm)	Labels per Roll	Printer Ribbon Series
<b>B-499: Nylon Cloth</b>								
▲	M7-16-499	White	9.53	25.40	-	12.70	500	R4300
▲	M7-7-499	White	12.70	12.70	-	15.88	500	R4300
▲	M7-29-499	White	12.70	38.10	-	15.88	500	R6200
▲	M7-11-499	White	12.70	19.05	-	15.88	500	R4300
▲	BM-11-499	White	12.70	19.05	-	15.88	5000	R4300, R6000HF
▲	M7-67-499-YL	Yellow	15.00	9.00	-	-	750	R4300
▲	M7-41-499-YL	Yellow	16.00	5.00	-	-	750	R4300
▲	M7-30-499	White	19.05	38.10	-	22.23	250	R4300
▲	M7-18-499	White	19.05	25.40	-	22.23	250	R4300
▲	M7-84-499	White	22.86	12.70	-	15.88	500	R4300, R4500, R4900, R6000HF, R6200
▲	M7-31-499	White	25.40	38.10	-	28.58	250	R4300, R6000HF, R6200
▲	M7-19-499	White	25.40	25.40	-	28.58	250	R4300
▲	M7-21-499	White	25.40	63.50	-	66.68	100	R4300, R4500, R4900, R6000HF, R6200
▲	M7-28-499	White	38.10	6.35	-	9.53	750	R4300, R4500, R4900, R6000HF, R6200
▲	M7-81-499	White	48.26	6.35	-	9.53	750	R4300
▲	M7-78-499	White	48.26	25.40	-	28.58	250	R4300
⊙	M7C-500-499	White	12.70	-	9.14	-	1	R4300, R6000HF, R6200
⊙	M7C-1000-499	White	25.40	-	9.14	-	1	R4300, R6000HF, R6200
⊙	M7C-1900-499	White	48.26	-	9.14	-	1	R4300, R6000HF, R6200
<b>B-595: Vinyl</b>								
⊙	M7C-500-595-BK	Black	12.70	-	15.24	-	1	R4400-WT
⊙	M7C-500-595-BL	Blue	12.70	-	15.24	-	1	R6000HF, R4400-WT
⊙	M7C-500-595-GN	Green	12.70	-	15.24	-	1	R6000HF, R4400-WT
⊙	M7C-500-595-OR	Orange	12.70	-	15.24	-	1	R6000HF, R4400-WT
⊙	M7C-500-595-RD	Red	12.70	-	15.24	-	1	R6000HF, R4400-WT
⊙	M7C-500-595-CL	Transparent	12.70	-	15.24	-	1	R6000HF, 4400-WT
⊙	M7C-500-595-WT	White	12.70	-	15.24	-	1	R6000HF
⊙	M7C-500-595-YL	Yellow	12.70	-	15.24	-	1	R6000HF, R4400-WT
⊙	M7C-1000-595-BK	Black	25.40	-	15.24	-	1	R4400-WT
⊙	M7C-1000-595-BL	Blue	25.40	-	15.24	-	1	R6000HF, R4400-WT
⊙	M7C-1000-595-GN	Green	25.40	-	15.24	-	1	R6000HF, R4400-WT
⊙	M7C-1000-595-OR	Orange	25.40	-	15.24	-	1	R6000HF, R4400-WT
⊙	M7C-1000-595-RD	Red	25.40	-	15.24	-	1	R6000HF, R4400-WT
⊙	M7C-1000-595-CL	Transparent	25.40	-	15.24	-	1	R6000HF, R4400-WT
⊙	M7C-1000-595-WT	White	25.40	-	15.24	-	1	R6000HF
⊙	M7C-1000-595-YL	Yellow	25.40	-	15.24	-	1	R6000HF, R4400-WT
⊙	M7C-2000-595-BK	Black	50.80	-	15.24	-	1	R4400-WT
⊙	M7C-2000-595-BL	Blue	50.80	-	15.24	-	1	R6000HF, R4400-WT
⊙	M7C-2000-595-GN	Green	50.80	-	15.24	-	1	R6000HF, R4400-WT
⊙	M7C-2000-595-OR	Orange	50.80	-	15.24	-	1	R6000HF, R4400-WT
⊙	M7C-2000-595-RD	Red	50.80	-	15.24	-	1	R6000HF, R4400-WT
⊙	M7C-2000-595-CL	Transparent	50.80	-	15.24	-	1	R6000HF, R4400-WT
⊙	M7C-2000-595-WT	White	50.80	-	15.24	-	1	R6000HF
⊙	M7C-2000-595-YL	Yellow	50.80	-	15.24	-	1	R6000HF, R4400-WT

Order references beginning with "B" indicate bulk rolls.

## Asset & component marking

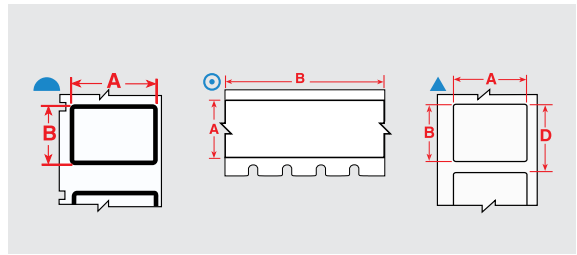

## Rating and name plate labels (Continued)

For smooth, high energy surfaces

Diagram	Order Reference	Colour	Label Width A (mm)	Label Height B (mm)	Label Length B (m)	Vertical Repeat D (mm)	Labels per Roll	Printer Ribbon Series
<b>B-423: Polyester</b>								
▲	M7-1-423	White	6.35	6.35	-	9.53	750	R6000HF
▲	M7-3-423	White	9.53	9.53	-	12.70	500	R6000HF
▲	M7-4-423	White	10.16	10.16	-	13.34	500	R6000HF
▲	M7-7-423	White	12.70	12.70	-	15.88	500	R6000HF
▲	M7-6-423	White	12.70	6.99	-	10.16	750	R6000HF
▲	M7-5-423	White	12.70	5.08	-	8.26	750	R6000HF
▲	BM-7-423	White	12.70	12.70	-	15.88	5000	R6000HF
▲	M7-9-423	White	16.51	5.08	-	8.26	750	R6000HF
▲	M7-10-423	White	19.05	6.35	-	9.53	750	R6000HF
▲	M7-13-423	White	22.86	6.35	-	9.53	750	R6000HF
▲	M7-20-423	White	25.40	50.80	-	53.98	100	R6000HF
▲	M7-19-423	White	25.40	25.40	-	28.58	250	R6000HF
▲	M7-17-423	White	25.40	12.70	-	15.88	500	R6000HF
▲	M7-16-423	White	25.40	9.53	-	12.70	500	R6000HF
▲	M7-15-423	White	25.40	6.99	-	10.16	750	R6000HF
▲	M7-14-423	White	25.40	4.75	-	8.26	750	R6000HF
▲	BM-17-423	White	25.40	12.70	-	15.88	5000	R6000HF
▲	BM-16-423	White	25.40	9.53	-	12.70	5000	R6000HF
▲	BM-19-423	White	25.40	25.40	-	28.58	2500	R6000HF
▲	M7-24-423-BK	White	28.70	12.70	-	15.88	500	R6000HF
▲	M7-25-423	White	31.75	6.35	-	9.53	750	R6000HF
▲	M7-32-423	White	38.10	38.10	-	41.28	250	R6000HF
▲	M7-31-423	White	38.10	25.40	-	28.58	250	R6000HF
▲	M7-29-423	White	38.10	12.70	-	15.88	500	R6000HF
▲	M7-28-423	White	38.10	6.35	-	9.53	750	R6000HF
▲	M7-27-423	White	38.10	3.18	-	6.35	750	R6000HF
▲	BM-29-423	White	38.10	12.70	-	15.88	5000	R6000HF
▲	M7-2-423	White	50.80	6.35	-	53.98	100	R6000HF
▲	BM-20-423	White	50.80	25.40	-	53.98	1000	R6000HF
▲	M7-26-423	White	69.85	31.75	-	73.03	100	R6000HF
▲	M7-37-423	White	76.20	48.26	-	79.38	100	R6000HF
▲	M7-22-423	White	76.20	25.40	-	79.38	100	R6000HF
▲	M7-38-423	White	101.60	48.26	-	104.78	100	R6000HF
▲	M7-23-423	White	101.60	25.40	-	104.78	100	R6000HF
⊙	M7C-500-423	White	12.70	-	15.24	-	1	R6000HF
<b>B-428: Metallised Polyester</b>								
▲	M7-20-428	Light Grey	25.40	50.80	-	53.98	100	R4300
▲	M7-17-428	Light Grey	25.40	12.70	-	15.88	500	R4300
▲	M7-15-428	Light Grey	25.40	6.99	-	10.16	750	R4300
▲	BM-17-428	Light Grey	25.40	12.70	-	15.88	5000	R4300
▲	M7-29-428	Light Grey	38.10	12.70	-	15.88	500	R4300
▲	BM-20-428	Light Grey	50.80	25.40	-	53.98	1000	R4300
▲	M7-26-428	Light Grey	69.85	31.75	-	73.03	100	R4300
▲	M7-22-428	Light Grey	76.20	25.40	-	79.38	100	R4300
▲	M7-38-428	Light Grey	101.60	48.26	-	104.78	100	R4300
⊙	M7C-500-428	Light Grey	12.70	-	15.24	-	1	R4300

Order references beginning with "B" indicate bulk rolls.

>>

▶ See pages 49 - 51 for a detailed material index.

## Asset & component marking

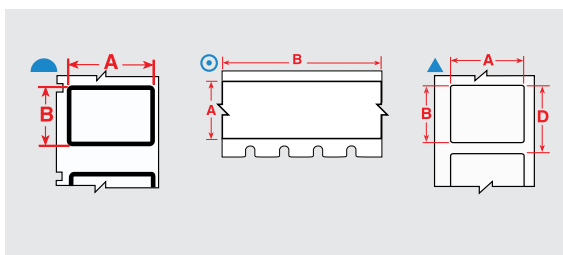

## Rating and name plate labels (Continued)

For smooth, high energy surfaces (Continued)

Diagram	Order Reference	Colour	Label Width A (mm)	Label Height B (mm)	Label Length B (m)	Vertical Repeat D (mm)	Labels per Roll	Printer Ribbon Series
<b>B-430: Polyester</b>								
▲	M7-71-430	Transparent	8.89	5.08	-	9.53	750	R6000HF
▲	M7-17-430	Transparent	25.40	12.70	-	15.88	500	R6000HF
▲	M7-16-430	Transparent	25.40	9.53	-	12.70	500	R6000HF
▲	M7-45-430	Transparent	38.10	9.53	-	12.70	500	R6000HF
◎	M7C-375-430	Transparent	9.53	-	15.24	-	1	R6000HF
◎	M7C-500-430	Transparent	12.70	-	15.24	-	1	R6000HF
◎	M7C-1000-430	Transparent	25.40	-	15.24	-	1	R6000HF
◎	M7C-1900-430	Transparent	50.80	-	15.24	-	1	R6000HF
<b>B-488: Polyester</b>								
▲	M7-80-488	White	19.05	22.86	-	28.58	250	R4300
▲	M7-97-488	White	22.86	22.86	-	28.58	250	R4300
▲	M7-81-488	White	48.26	6.35	-	9.53	750	R4300
<b>B-529: Polypropylene</b>								
◎	M7C-1000-529	White	25.40	-	15.24	-	1	R6000HF
◎	M7C-2000-529	White	50.80	-	15.24	-	1	R6000HF

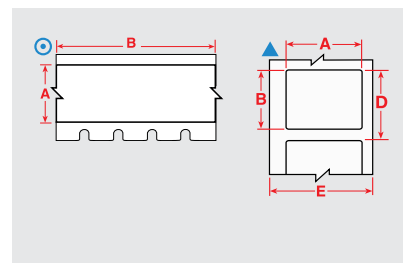

## Security identification labels

Tamper-resistant tape destructs into tiny fragments when being removed, makes any attempts to remove the label very difficult and time consuming.

Diagram	Order Reference	Colour	Label Width A (mm)	Label Height B (mm)	Label Length B (m)	Vertical Repeat D (mm)	Labels per Roll	Printer Ribbon Series
<b>B-351: Tamper-resistant Vinyl</b>								
▲	M7-20-351	White	25.40	50.80	-	53.98	100	R6000HF
▲	M7-17-351	White	25.40	12.70	-	15.88	500	R6000HF
▲	M7-31-351	White	38.10	25.40	-	28.58	250	R6000HF
▲	M7-37-351	White	76.20	48.26	-	79.38	100	R6000HF
<b>B-362: Tamper-resistant Metallised Vinyl</b>								
▲	M7-17-362	Silver	25.40	12.70	-	15.88	500	R6000HF
▲	M7-31-362	Silver	25.40	38.10	-	28.58	250	R6000HF
▲	M7-20-362	Silver	50.80	25.40	-	53.98	100	R6000HF
▲	M7-37-362	Silver	76.20	48.26	-	79.38	100	R6000HF
<b>B-530: Tamper-resistant Vinyl</b>								
◎	M7C-500-530	White	12.70	-	15.24	-	1	R6000HF
◎	M7C-1000-530	White	25.40	-	15.24	-	1	R6000HF
◎	M7C-2000-530	White	50.80	-	15.24	-	1	R6000HF



# Safety & facility identification

## Pipe and valve marking / Safety signage



## High performance indoor/outdoor vinyl

- Adheres to difficult low surface energy items, including: PVC piping, blow-molded equipment cases, ABS plastics, powder-coated surfaces and equipment made from recycled plastics.
- Excels at sticking to highly textured surfaces such as painted cinder block walls, finished uneven wood, textured plastics, rough-pipes and paper-jacketed pipes.
- 8 to 10\*\* year outdoor durability average in temperatures from -40°C to 82°C, can be applied as low as -18 °C

Diagram	Order Reference	Colour	Finish	Label Width A (mm)	Label Length B (m)	Labels per Roll	Printer Ribbon Series
B-595: Vinyl							
⊙	M7C-500-595-BK	Black	Gloss	12.70	15.24 m	1	R4400-WT
⊙	M7C-500-595-BL	Blue	Gloss	12.70	15.24 m	1	R6000HF, R4400-WT
⊙	M7C-500-595-BR	Brown	Gloss	12.70	15.24 m	1	R6000HF, R4400-WT
⊙	M7C-500-595-GD	Gold	Gloss	12.70	15.24 m	1	R6000HF, R4400-WT
⊙	M7C-500-595-GN	Green	Gloss	12.70	15.24 m	1	R6000HF, R4400-WT
⊙	M7C-500-595-GY	Grey	Gloss	12.70	15.24 m	1	R6000HF, R4400-WT
⊙	M7C-500-595-LB	Light Blue	Gloss	12.70	15.24 m	1	R6000HF, R4400-WT
⊙	M7C-500-595-OC	Ochre	Gloss	12.70	15.24 m	1	R6000HF, R4400-WT
⊙	M7C-500-595-OR	Orange	Gloss	12.70	15.24 m	1	R6000HF, R4400-WT
⊙	M7C-500-595-PK	Pink	Gloss	12.70	15.24 m	1	R6000HF, R4400-WT
⊙	M7C-500-595-PL	Purple	Gloss	12.70	15.24 m	1	R6000HF, R4400-WT
⊙	M7C-500-595-RD	Red	Gloss	12.70	15.24 m	1	R6000HF, R4400-WT
⊙	M7C-500-595-SB	Sky Blue	Gloss	12.70	15.24 m	1	R6000HF, R4400-WT
⊙	M7C-500-595-TN	Tan	Gloss	12.70	15.24 m	1	R6000HF, R4400-WT
⊙	M7C-500-595-CL	Transparent	Gloss	12.70	15.24 m	1	R6000HF, R4400-WT
⊙	M7C-500-595-WT	White	Gloss	12.70	15.24 m	1	R6000HF
⊙	M7C-500-595-YL	Yellow	Gloss	12.70	15.24 m	1	R6000HF, R4400-WT
⊙	M7C-1000-595-BK	Black	Gloss	25.40	15.24 m	1	R4400-WT
⊙	M7C-1000-595-BL	Blue	Gloss	25.40	15.24 m	1	R6000HF, R4400-WT
⊙	M7C-1000-595-BR	Brown	Gloss	25.40	15.24 m	1	R6000HF, R4400-WT
⊙	M7C-1000-595-GD	Gold	Gloss	25.40	15.24 m	1	R6000HF, R4400-WT
⊙	M7C-1000-595-GN	Green	Gloss	25.40	15.24 m	1	R6000HF, R4400-WT
⊙	M7C-1000-595-GY	Grey	Gloss	25.40	15.24 m	1	R6000HF, R4400-WT
⊙	M7C-1000-595-LB	Light Blue	Gloss	25.40	15.24 m	1	R6000HF, R4400-WT
⊙	M7C-1000-595-OC	Ochre	Gloss	25.40	15.24 m	1	R6000HF, R4400-WT
⊙	M7C-1000-595-OR	Orange	Gloss	25.40	15.24 m	1	R6000HF, R4400-WT
⊙	M7C-1000-595-PK	Pink	Gloss	25.40	15.24 m	1	R6000HF, R4400-WT
⊙	M7C-1000-595-PL	Purple	Gloss	25.40	15.24 m	1	R6000HF, R4400-WT
⊙	M7C-1000-595-RD	Red	Gloss	25.40	15.24 m	1	R6000HF, R4400-WT
⊙	M7C-1000-595-SB	Sky Blue	Gloss	25.40	15.24 m	1	R6000HF, R4400-WT
⊙	M7C-1000-595-TN	Tan	Gloss	25.40	15.24 m	1	R6000HF, R4400-WT
⊙	M7C-1000-595-CL	Transparent	Gloss	25.40	15.24 m	1	R6000HF, R4400-WT
⊙	M7C-1000-595-WT	White	Gloss	25.40	15.24 m	1	R6000HF
⊙	M7C-1000-595-YL	Yellow	Gloss	25.40	15.24 m	1	R6000HF, R4400-WT
⊙	M7C-2000-595-BK	Black	Gloss	50.80	15.24 m	1	R4400-WT
⊙	M7C-2000-595-BL	Blue	Gloss	50.80	15.24 m	1	R6000HF, R4400-WT
⊙	M7C-2000-595-BR	Brown	Gloss	50.80	15.24 m	1	R6000HF, R4400-WT
⊙	M7C-2000-595-GD	Gold	Gloss	50.80	15.24 m	1	R6000HF, R4400-WT
⊙	M7C-2000-595-GN	Green	Gloss	50.80	15.24 m	1	R6000HF, R4400-WT
⊙	M7C-2000-595-GY	Grey	Gloss	50.80	15.24 m	1	R6000HF, R4400-WT
⊙	M7C-2000-595-LB	Light Blue	Gloss	50.80	15.24 m	1	R6000HF, R4400-WT
⊙	M7C-2000-595-OC	Ochre	Gloss	50.80	15.24 m	1	R6000HF, R4400-WT
⊙	M7C-2000-595-OR	Orange	Gloss	50.80	15.24 m	1	R6000HF, R4400-WT
⊙	M7C-2000-595-PK	Pink	Gloss	50.80	15.24 m	1	R6000HF, R4400-WT
⊙	M7C-2000-595-PL	Purple	Gloss	50.80	15.24 m	1	R6000HF, R4400-WT
⊙	M7C-2000-595-RD	Red	Gloss	50.80	15.24 m	1	R6000HF, R4400-WT
⊙	M7C-2000-595-SB	Sky Blue	Gloss	50.80	15.24 m	1	R6000HF, R4400-WT
⊙	M7C-2000-595-TN	Tan	Gloss	50.80	15.24 m	1	R6000HF, R4400-WT
⊙	M7C-2000-595-CL	Transparent	Gloss	50.80	15.24 m	1	R6000HF, R4400-WT
⊙	M7C-2000-595-WT	White	Gloss	50.80	15.24 m	1	R6000HF
⊙	M7C-2000-595-YL	Yellow	Gloss	50.80	15.24 m	1	R6000HF, 4400-WT

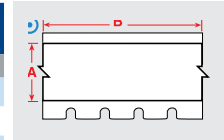

\*\*Average expected outdoor life of product will depend on user definition of failure, climatic conditions, mounting techniques and material colour. The up to 8 to 10 year outdoor durability applies to the vinyl label stock only; ribbon durability will vary. A polyester overlamine is recommended for harsh environments - long term exposure to wind and rain.

>>

## Safety signage

### Cold temperature application material

- Special adhesive permanently adheres to extremely cold surfaces
- Ideal for cold storage warehouses, fridges, freezers and short-term outdoor use in winter
- Service temp: -40 °C to 100 °C
- Application temp: -23 °C to 100 °C



Diagram	Order Reference	Colour	Finish	Label Width A (mm)	Label Length B (m)	Printer Ribbon Series
B-549: Polyester						
∞	M7C-1000-549-WT	White	Gloss	25.40	15.24 m	R6000HF, R10000
∞	M7C-1000-549-YL	Yellow	Gloss	25.40	15.24 m	R6000HF, R10000
∞	M7C-2000-549-WT	White	Gloss	50.80	15.24 m	R6000HF, R10000
∞	M7C-2000-549-YL	Yellow	Gloss	50.80	15.24 m	R6000HF, R10000

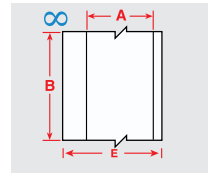

### High performance polyester tape

- Recommended for low-halide labeling onto stainless steel pipes and surfaces in harsh environments.
- Applies best to very smooth surfaces and ideal for mounting to rigid panels.



Diagram	Order Reference	Colour	Finish	Label Width A (mm)	Label Length B (m)	Labels per Roll	Printer Ribbon Series
B-569: Polyester							
∞	M7C-1000-569-BL	Blue	Gloss	25.40	15.24 m	1	R6000HF, R10000
∞	M7C-1000-569-GN	Green	Gloss	25.40	15.24 m	1	R6000HF, R10000
∞	M7C-1000-569-RD	Red	Gloss	25.40	15.24 m	1	R6000HF, R10000
∞	M7C-1000-569-WT	White	Gloss	25.40	15.24 m	1	R6000HF, R10000
∞	M7C-1000-569-YL	Yellow	Gloss	25.40	15.24 m	1	R6000HF, R10000
∞	M7C-2000-569-BL	Blue	Gloss	50.80	15.24 m	1	R6000HF, R10000
∞	M7C-2000-569-GN	Green	Gloss	50.80	15.24 m	1	R6000HF, R10000
∞	M7C-2000-569-RD	Red	Gloss	50.80	15.24 m	1	R6000HF, R10000
∞	M7C-2000-569-WT	White	Gloss	50.80	15.24 m	1	R6000HF, R10000
∞	M7C-2000-569-YL	Yellow	Gloss	50.80	15.24 m	1	R6000HF, R10000

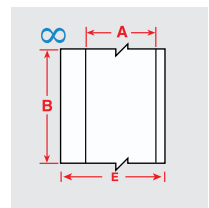

### Food processing equipment marking

#### ToughWash series labels

- Durable label construction resists harsh washdown environments and has been tested at washdown temperatures up to 80°C (175° F) and pressures up to 1500 PSI.
- B-854 is a metal detectable version, capable of being detected by commercially available metal detectors.



Diagram	Order Reference	Colour	Finish	Label Width A (mm)	Label Length B (m)	Printer Ribbon Series
B-854: Metal Detectable Polyester						
⊙	BM7C-2000-854-CAU	Black, Yellow on White	Matt	104.78		R6000HF
⊙	BM7C-1000-854-WT	White	Matt	25.40	22.86 m	R6000HF
⊙	BM7C-1000-854-YL	Yellow	Matt	25.40	22.86 m	R6000HF
⊙	BM7C-2000-854-WT	White	Matt	50.80	22.86 m	R6000HF
⊙	BM7C-2000-854-YL	Yellow	Matt	50.80	22.86 m	R6000HF
B-855: Polyester						
⊙	BM7C-1000-855-WT	White	Matt	25.40	22.86 m	R6000HF
⊙	BM7C-1000-855-YL	Yellow	Matt	25.40	22.86 m	R6000HF
⊙	BM7C-2000-855-WT	White	Matt	50.80	22.86 m	R6000HF
⊙	BM7C-2000-855-YL	Yellow	Matt	50.80	22.86 m	R6000HF

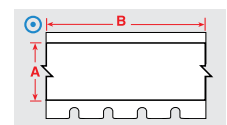

### Exit & directional signs

#### Photoluminescent polyester tapes

Glow-in-the-dark material. Ideal for exit and directional signs, identification of fire alarms and extinguishers, low location egress pathway markings, and directional systems for escape or evacuation routes.

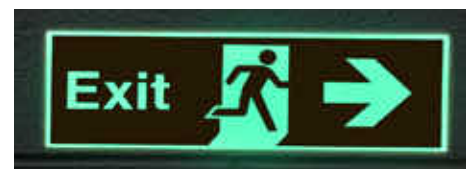
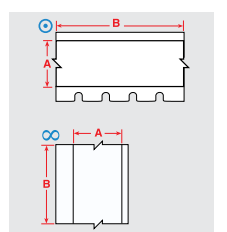

Diagram	Order Reference	Colour	Finish	Label Width A (mm)	Label Length B (m)	Printer Ribbon Series
B-526: Phosphorescent Polyester						
∞	BM7C-1000-526	White	Gloss	25.40	22.86 m	R10000
∞	BM7C-2000-526	White	Gloss	50.80	22.86 m	R10000
B-582: Phosphorescent Polyester						
⊙	BM7C-1000-582	Photoluminescent Green	Gloss	25.40	22.86 m	R6000HF
⊙	BM7C-2000-582	Photoluminescent Green	Gloss	50.80	22.86 m	R6000HF



Order references beginning with "B" indicate bulk rolls.

▶ See pages 49 - 51 for a detailed material index.

# Safety & facility identification

## Maintenance

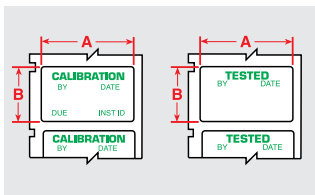

## Pre-printed maintenance labels

- M710 printable maintenance labels with pre-printed text allow customers to print variable information next to relevant pre-printed titles.

Order Reference	Legend	Colour	Finish	Label Width A (mm)	Label Height B (mm)	Repeat (mm)	Labels per Roll	Printer Ribbon Series
B-428: Metallised Polyester								
M7-30-428-CALI	CALIBRATION	Green on Grey	Matt	38.10	19.05	22.23	250	R4300
B-423: Polyester								
M7-30-423-TEST	TESTED	Green on White	Gloss	38.10	19.05	22.23	250	R6000HF

## Area and pathway marking



## ToughStripe area marking tape

- Create custom-printed floor labels, with easy 3-step process: print label, position on floor, apply overlaminat.
- Each kit includes 1 roll of B-483 tape and 1 roll of B-634 overlaminat.

Diagram	Order Reference	Colour	Finish	Label Width A (mm)	Label Length B (m)	Printer Ribbon Series
B-483A/B-634: Polyester with Polyester Overlaminat						
⊙	M7-1000-483-BK-KT	Black	Gloss	25.40	15.24 m	R4400-WT, R6000HF
⊙	M7-1000-483-BL-KT	Blue	Gloss	25.40	15.24 m	R6000HF, R4400
⊙	M7-1000-483-GN-KT	Green	Gloss	25.40	15.24 m	R6000HF, R4400
⊙	M7-1000-483-OR-KT	Orange	Gloss	25.40	15.24 m	R6000HF, R4400
⊙	M7-1000-483-RD-KT	Red	Gloss	25.40	15.24 m	R6000HF, R4400
⊙	M7-1000-483-WT-KT	White	Gloss	25.40	15.24 m	R6000HF
⊙	M7-1000-483-YL-KT	Yellow	Gloss	25.40	15.24 m	R6000HF, R4400
⊙	M7-2000-483-BK-KT	Black	Gloss	50.80	15.24 m	R4400-WT, R6000HF
⊙	M7-2000-483-BL-KT	Blue	Gloss	50.80	15.24 m	R6000HF, R4400
⊙	M7-2000-483-GN-KT	Green	Gloss	50.80	15.24 m	R6000HF, R4400
⊙	M7-2000-483-OR-KT	Orange	Gloss	50.80	15.24 m	R6000HF, R4400
⊙	M7-2000-483-RD-KT	Red	Gloss	50.80	15.24 m	R6000HF, R4400
⊙	M7-2000-483-WT-KT	White	Gloss	50.80	15.24 m	R4400-WT
⊙	M7-2000-483-YL-KT	Yellow	Gloss	50.80	15.24 m	R6000HF, R4400

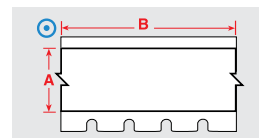

## Safety signs and labels

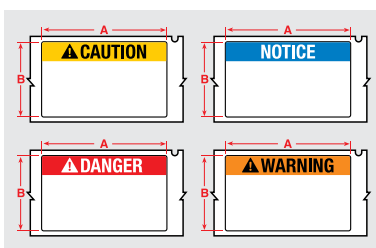

## Pre-printed safety labels

M710 printable safety labels with pre-printed headers allow customers to print variable information next to highly visible titles.

Order Reference	Legend	Colour	Finish	Label Width A (mm)	Label Height B (mm)	Repeat (mm)	Labels per Roll	Printer Ribbon Series
B-483A: Polyester								
M7-38-483-CAUTION	CAUTION	Black, Yellow on White	Gloss	101.60	48.26	104.78	100	R6000HF
M7-38-483-DANGER	DANGER	Red on White	Gloss	101.60	48.26	104.78	100	R6000HF
M7-38-483-NOTICE	NOTICE	Blue on White	Gloss	101.60	48.26	104.78	100	R6000HF
M7-38-483-WARNING	WARNING	Black, Orange on White	Gloss	101.60	48.26	104.78	100	R6000HF

## Safety signs and labels

### Reflective tapes

The reflective quality of this material makes it ideal for reading labels in low light conditions (with flashlights).



Diagram	Order Reference	Colour	Finish	Label Width A (mm)	Label Length B (m)	Printer Ribbon Series
B-584: Reflective Tape						
⊙	BMC-1000-584-OR	Orange	Gloss	25.40	22.86 m	R6000HF
⊙	BMC-1000-584-WT	White	Gloss	25.40	22.86 m	R6000HF
⊙	BMC-1000-584-YL	Yellow	Gloss	25.40	22.86 m	R6000HF
⊙	BMC-2000-584-OR	Orange	Gloss	50.80	22.86 m	R6000HF
⊙	BMC-2000-584-WT	White	Gloss	50.80	22.86 m	R6000HF
⊙	BMC-2000-584-YL	Yellow	Gloss	50.80	22.86 m	R6000HF

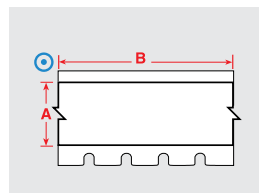

Order references with "C" (e.g. M71C) indicate continuous. Order references beginning with "B" indicate bulk rolls.

## Lean warehouse labels

### Printable magnetic supply

- Non-adhesive magnetic material that can be printed on directly
- Ideal for reusable and repositionable identification applications



Diagram	Order Reference	Colour	Finish	Label Width A (mm)	Label Length B (m)	Printer Ribbon Series
B-509: Magnetic Polyester						
∞	BM7C-1000-509-WT	White	Gloss	25.40	7.62	R10000
∞	BM7C-1000-509-YL	Yellow	Matt	25.40	7.62	R10000
∞	BM7C-1800-509-WT	White	Matt	45.72	7.62	R10000
∞	BM7C-1800-509-YL	Yellow	Matt	45.72	7.62	R10000

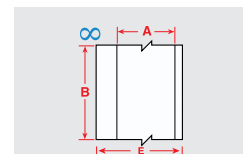

### Paper labels

- Economical choice for light duty general id.
- White finish and mattx topcoat.
- Excellent contrast and smear resistance for barcode printing.



Diagram	Order Reference	Colour	Label Width A (mm)	Label Height B (mm)	Vertical Repeat D (mm)	Labels per Roll	Printer Ribbon Series
B-424: Paper							
▲	M7-20-424	White	25.40	50.80	53.98	100	R4300
▲	BM-20-424	White	50.80	25.40	53.98	1000	R4300

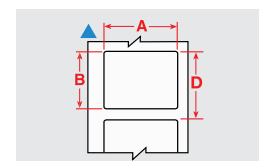

Order references beginning with "B" indicate bulk rolls.

### Repositionable vinyl

Best choice for indoor marking where frequent repositioning is required, such as shelves. Special adhesive allows easy removal of label to re-apply again and again.



Diagram	Order Reference	Colour	Finish	Label Width A (mm)	Label Length B (m)	Printer Ribbon Series
B-581: Vinyl						
⊙	M7C-500-581-WT	White	Gloss	12.70	15.24 m	R6000HF
⊙	M7C-500-581-YL	Yellow	Gloss	12.70	15.24 m	R6000HF
⊙	M7C-1000-581-WT	White	Gloss	25.40	15.24 m	R6000HF
⊙	M7C-1000-581-YL	Yellow	Gloss	25.40	15.24 m	R6000HF
⊙	M7C-2000-581-WT	White	Gloss	50.80	15.24 m	R6000HF
⊙	M7C-2000-581-YL	Yellow	Gloss	50.80	15.24 m	R6000HF

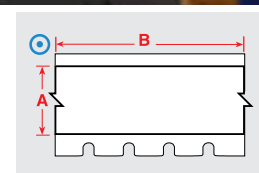

▶ See pages 49 - 51 for a detailed material index.



## Circuit board marking

### Thermal transfer printable products circuit board process chart

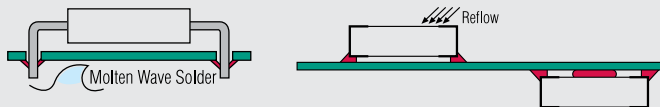

	Through Hole Technology		Surface Mount Technology (SMT)	
	Top	Bottom	Top or Bottom	After Process
B-717, B-718, B-719, B-724, B-727	Yes	Yes	Yes	Yes
B-422, B-423, B-430, B-437, B-459, B-473, B-488	Yes*	No	No	Yes

\*In extreme high temperature, testing of these materials is recommended



### Polyester labels

Various types of high resistant polyester materials for relays, solenoids, PCB's, electronic components and more.

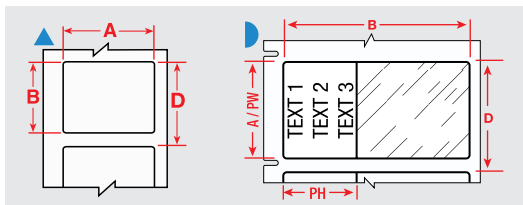

Diagram	Order Reference	Colour	Label Width A (mm)	Label Height B (mm)	Vertical Repeat D (mm)	Labels per Roll	Printer Ribbon Series
B-423: Polyester							
▲	M7-1-423	White	6.35	6.35	9.53	750	R6000HF
▲	M7-3-423	White	9.53	9.53	12.70	500	R6000HF
▲	M7-4-423	White	10.16	10.16	13.34	500	R6000HF
▲	M7-7-423	White	12.70	12.70	15.88	500	R6000HF
▲	M7-6-423	White	12.70	6.99	10.16	750	R6000HF
▲	M7-5-423	White	12.70	5.08	8.26	750	R6000HF
▲	BM-7-423	White	12.70	12.70	15.88	5000	R6000HF
▲	M7-9-423	White	16.51	5.08	8.26	750	R6000HF
▲	M7-10-423	White	19.05	6.35	9.53	750	R6000HF
▲	M7-13-423	White	22.86	6.35	9.53	750	R6000HF
▲	M7-19-423	White	25.40	25.40	28.58	250	R6000HF
▲	M7-17-423	White	25.40	12.70	15.88	500	R6000HF
▲	M7-16-423	White	25.40	9.53	12.70	500	R6000HF
▲	M7-15-423	White	25.40	6.99	10.16	750	R6000HF
▲	M7-14-423	White	25.40	4.75	8.26	750	R6000HF
▲	BM-17-423	White	25.40	12.70	15.88	5000	R6000HF
▲	BM-16-423	White	25.40	9.53	12.70	5000	R6000HF
▲	BM-19-423	White	25.40	25.40	28.58	2500	R6000HF
▲	M7-25-423	White	31.75	6.35	9.53	750	R6000HF
▲	M7-32-423	White	38.10	38.10	41.28	250	R6000HF
▲	M7-31-423	White	38.10	25.40	28.58	250	R6000HF
▲	M7-29-423	White	38.10	12.70	15.88	500	R6000HF
▲	M7-28-423	White	38.10	6.35	9.53	750	R6000HF
▲	M7-27-423	White	38.10	3.18	6.35	750	R6000HF
▲	BM-29-423	White	38.10	12.70	15.88	5000	R6000HF

Order references beginning with "B" indicate bulk rolls.

>>

## Circuit board marking

### Polyester labels (continued)

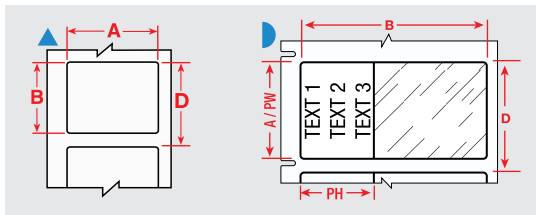

Diagram	Order Reference	Colour	Label Width A (mm)	Label Height B (mm)	Vertical Repeat D (mm)	Labels per Roll	Printer Ribbon Series
<b>B-459: Polyester</b>							
▲	M7-20-459	White	25.40	50.80	53.98	100	R6000HF
▲	M7-30-459	White	38.10	19.05	22.23	250	R6000HF
▲	M7-29-459	White	38.10	12.70	15.88	500	R6000HF
<b>B-473: Static Dissipative Polyester</b>							
▲	M7-6-473	White	12.70	6.99	10.16	750	R6000HF
▲	M7-9-473	White	16.51	5.08	8.26	750	R6000HF
▲	M7-10-473	White	19.05	6.35	9.53	750	R6000HF
▲	M7-17-473	White	25.40	12.70	15.88	500	R6000HF
▲	M7-16-473	White	25.40	9.53	12.70	500	R6000HF
▾	M7-28-473	White	38.10	6.35	9.53	750	R6000HF

### Polyimide labels

Various types of high resistant polyimide materials for relays, solenoids, PCB's and electronic components.

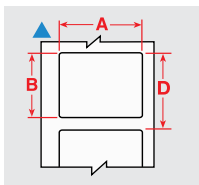

Diagram	Order Reference	Colour	Label Width A (mm)	Label Height B (mm)	Vertical Repeat D (mm)	Labels per Roll	Printer Ribbon Series
<b>B-717: Polyimide</b>							
▲	M7-14-717	White	25.40	4.75	8.26	750	R6000HF
▲	M7-2-717	White	50.80	6.35	53.98	100	R6000HF
<b>B-718: Polyimide</b>							
▲	M7-4-718	White	10.16	10.16	13.34	500	R6000HF
▲	M7-9-718	White	16.51	5.08	8.26	750	R6000HF
▲	M7-25-718	White	31.75	6.35	9.53	750	R6000HF
<b>B-724: Polyimide</b>							
▲	M7-9-724	Amber	16.51	5.08	8.26	750	R4300
▲	M7-13-724	Amber	22.86	6.35	9.53	750	R4300
▲	M7-17-724	Amber	25.40	12.70	15.88	500	R4300
▲	M7-16-724	Amber	25.40	9.53	12.70	500	R4300
▲	M7-28-724	Amber	38.10	6.35	9.53	750	R4300
<b>B-727: Polyimide</b>							
▲	M7-10-727	White	19.05	6.35	9.53	750	R6000HF
▲	M7-16-727	White	25.40	9.53	12.70	500	R6000HF

▶ See pages 49 - 51 for a detailed material index.

## Specimen tracking identification



### Straw & rod labelling

Brady offers a range of labels designed to fit the small surface area of straws and rods and will withstand long-term storage.

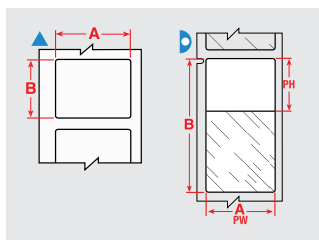

Labels are shown per vial / tube size and in order of label width.

The background colours in the Order Reference column represent the material colour.

Diagram	Material	Special Properties	Label Width A (mm)	Label Height B (mm)	Printable Area Width PW (mm)	Printable Area Height PH (mm)	Order Reference	Printer Ribbon Series	Labels per Roll
<b>0.25 ml</b>									
▷	B-427	F N S	25.40	25.40	25.40	9.53	BM-19-427	R4300	2500
▷	B-461	F N A H S L	25.40	25.40	25.40	9.53	M7-19-461	R4300	250
▷	B-427	F N S	25.40	25.40	25.40	9.53	M7-19-427	R4300	250
▷	B-427	F N S	25.40	25.40	25.40	9.53	M7-19-427-YL	R4300, R4400, R6700	250
<b>0.25 ml Straw</b>									
▲	B-492	F N H L	25.40	25.40	-	-	M7-19-492	R6400	250
<b>0.3 ml</b>									
▷	B-427	F N S	25.40	63.50	25.40	19.05	BM-21-427	R4300	1000
▷	B-427	F N S	25.40	63.50	25.40	19.05	M7-21-427	R4300	100
▷	B-427	F N S	25.40	63.50	25.40	19.05	M7-21-427-YL	R4300, R4400, R6700	100

Order references beginning with "B" indicate bulk rolls.



### Vial tops

Save time by using the Vial and Vial top combination labels - print your information in one go.

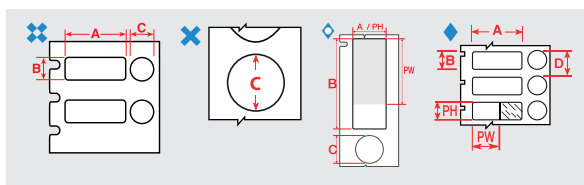

Diagram	Material	Special Properties	Label Width A (mm)	Label Height B (mm)	Diameter C (mm)	Printable Area Width PW (mm)	Printable Area Height PH (mm)	Order Reference	Printer Ribbon Series	Labels per Roll
<b>0.6 - 1.5 ml</b>										
✕	B-499	F A	-	-	9.53	-	-	M7-82-499	R4300, R6000HF, R6200	500
<b>1.0 - 2.0 ml</b>										
✕	B-499	F A	-	-	12.70	-	-	M7-83-499	R4300, R6000HF, R6200	500
◇	B-461	F A H S L	15.24	41.28	12.70	15.24	30.00	M7-116-461	R6200	150
✱	B-492	F H L	25.40	12.70	9.53	-	-	M7-118-492	R6400	500
◆	B-461	F A H S L	40.00	15.00	9.53	29.97	15.00	M7-101-461	R6200	250
<b>1.0 - 8.0 ml</b>										
✱	B-499	F A	22.86	12.70	12.70	-	-	M7-126-499	R4300	500

F Freezer environment N Liquid nitrogen environment A Autoclave environment H Hot water bath (100°C) S Self-laminating label L Low-profile (extremely thin) label R Removable

▶ See pages 49 - 51 for a detailed material index.

## Specimen tracking identification

### Vial / tube labels

Brady's vial and test tube labels are designed to withstand extreme laboratory solvents like Xylene, Ethanol, Alcohol and DMSO, ensuring that the specimen identification is always legible - and will not smear, fade or fall off.

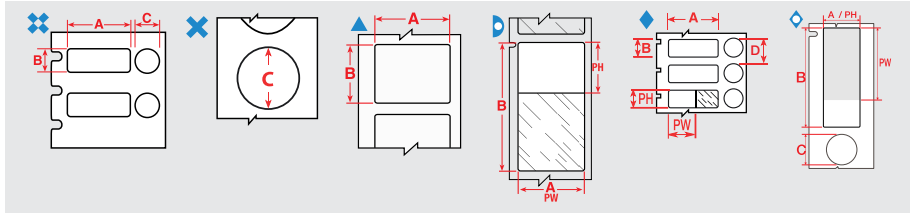

Labels are shown per vial / tube size and in order of label width.

The background colours in the Order Reference column represent the material colour.

Diagram	Material	Special Properties	Label Width A (mm)	Label Height B (mm)	Label Length B (m)	Diameter C (mm)	Printable Area Width PW (mm)	Printable Area Height PH (mm)	Order Reference	Printer Ribbon Series	Labels per Roll
<b>0.5 - 0.7 ml</b>											
▲	B-498	F	R	9.53	25.40	-	-	-	M7-16-498	R6200	500
▷	B-461	F N A H S L	9.53	45.72	-	-	9.53	19.05	M7-73-461	R6200	250
▲	B-498	F	R	12.70	19.05	-	-	-	BM-11-498	R6200	5000
▲	B-492	F N H L	25.40	9.53	-	-	-	-	M7-16-492	R6400	500
✘	B-499	F A	25.40	9.53	-	9.53	-	-	M7-98-499	R4300	500
<b>0.6 - 1.5 ml</b>											
✘	B-499	F A	-	-	-	9.53	-	-	M7-82-499	R4300, R6000H, R6200	500
<b>1.0 - 2.0 ml</b>											
✘	B-499	F A	-	-	-	12.70	-	-	M7-83-499	R4300, R6000HF, R6200	500
▷	B-461	F N A H S L	15.24	38.10	-	-	15.24	33.00	M7-100-461	R6200	500
◇	B-461	F A H S L	15.24	41.28	-	12.70	15.24	30.00	M7-116-461	R6200	150
✘	B-492	F H L	25.40	12.70	-	9.53	-	-	M7-118-492	R6400	500
▷	B-461	F N A H S L	25.40	44.45	-	-	25.40	25.40	M7-106-461	R6200	250
◆	B-461	F A H S L	40.00	15.00	-	9.53	29.97	15.00	M7-101-461	R6200	250
<b>1.0 - 8.0 ml</b>											
▷	B-461	F N A H S L	15.24	41.28	-	-	15.24	25.40	M7-76-461	R6200	500
▷	B-461	F N A H S L	15.24	66.68	-	-	15.24	25.40	M7-86-461	R6200	100
✘	B-499	F A	22.86	12.70	-	12.70	-	-	M7-126-499	R4300	500
▷	B-461	F N A H S L	25.40	66.68	-	-	25.40	25.40	M7-115-461	R6200	100
▲	B-490	F N H L	41.28	15.24	-	-	-	-	M7-76-490	R4300	500
▲	B-492	F N H L	48.26	25.40	-	-	-	-	M7-78-492	R6400	250
<b>2.0 - 4.0 ml</b>											
▷	B-461	F N A H S L	15.24	48.26	-	-	15.24	40.00	M7-119-461	R6200	500
<b>12.0 - 24.0 ml</b>											
▲	B-498	F	R	12.70	38.10	-	-	-	BM-29-498	R6200	5000
▲	B-498	F	R	38.10	12.70	-	-	-	M7-29-498	R6200	500
<b>50.0 ml</b>											
▷	B-427	F N S	19.05	38.10	-	-	19.05	12.70	BM-30-427	R4300	2500
▲	B-498	F	R	25.40	12.70	-	-	-	M7-17-498	R6200	500
▲	B-498	F	R	25.40	38.10	-	-	-	M7-31-498	R6200	250
▲	B-427	F N S	38.10	19.05	-	-	-	-	M7-30-427-AW	R4300, R4400, R6700	250

Order references beginning with "B" indicate bulk rolls. \*AW = All White / no transparent area.

F Freezer environment N Liquid nitrogen environment A Autoclave environment H Hot water bath (100°C) S Self-laminating label L Low-profile (extremely thin) label R Removable



## Specimen tracking identification



### Conical & large tube labelling

Brady offers several sample identification labels which are perfect to identify conicals. They are easy to handle, have great flexibility and easily wrap around curved sample containers. Your sample identification label will remain attached and legible, even when the sample is stored in a freezer, in liquid nitrogen or heated in an autoclave.

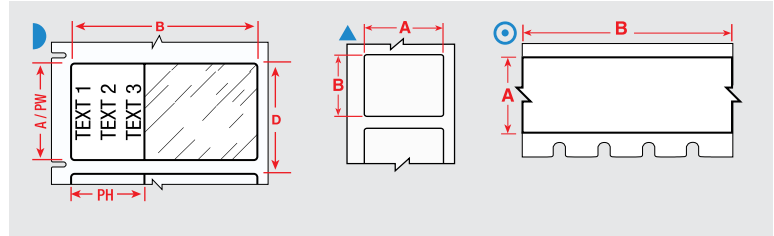

Labels are shown per vial / tube size and in order of label width.

The background colours in the Order Reference column represent the material colour.

Diagram	Material	Special Properties	Label Width A (mm)	Label Height B (mm)	Label Length C (mm)	Diameter D (mm)	Printable Area Width PW (mm)	Printable Area Height PH (mm)	Order Reference	Printer Ribbon Series	Labels per Roll
<b>1.0 - 8.0 ml</b>											
▲	B-499	F N A	48.26	25.40	-	-	-	-	M7-78-499	R4300	250
<b>1.5 ml</b>											
◎	B-430	F A H	12.70	-	15.24	-	-	-	M7C-500-430	R6000HF	1
<b>12.0 - 24.0 ml</b>											
▲	B-498	F	12.70	38.10	-	-	-	-	BM-29-498	R6200	5000
▲	B-499	F N A	12.70	38.10	-	-	-	-	M7-29-499	R6200	500
▲	B-498	F	38.10	12.70	-	-	-	-	M7-29-498	R6200	500
<b>50.0 ml</b>											
▲	B-423	F A H	12.70	12.70	-	-	-	-	BM-7-423	R6000HF	5000
▲	B-423	F A H	12.70	12.70	-	-	-	-	M7-7-423	R6000HF	500
▲	B-499	F N A	19.05	38.10	-	-	-	-	M7-30-499	R4300	250
▶	B-427	F N S	19.05	38.10	-	-	19.05	12.70	BM-30-427	R4300	2500
▲	B-423	F A H	25.40	4.75	-	-	-	-	M7-14-423	R6000HF	750
▲	B-423	F A H	25.40	6.99	-	-	-	-	M7-15-423	R6000HF	750
▲	B-423	F A H	25.40	12.70	-	-	-	-	M7-17-423	R6000HF	500
▲	B-492	F N H L	25.40	12.70	-	-	-	-	M7-17-492	R6400	500
▲	B-498	F	25.40	12.70	-	-	-	-	M7-17-498	R6200	500
▲	B-498	F	25.40	38.10	-	-	-	-	M7-31-498	R6200	250
▲	B-499	F N A	25.40	38.10	-	-	-	-	M7-31-499	R4300, R6000HF, R6200	250
▲	B-423	F A H	25.40	50.80	-	-	-	-	M7-20-423	R6000HF	100
▲	B-427	F N S	38.10	19.05	-	-	-	-	M7-30-427-AW	R4300, R4400, R6700	250
▲	B-423	F A H	38.10	25.40	-	-	-	-	M7-31-423	R6000HF	250
▲	B-423	F A H	50.80	25.40	-	-	-	-	BM-20-423	R6000HF	1000
▲	B-423	F A H	76.20	25.40	-	-	-	-	M7-22-423	R6000HF	100

Order references beginning with "B" indicate bulk rolls. \*AW = All White / no transparent area.

F Freezer environment N Liquid nitrogen environment A Autoclave environment H Hot water bath (100°C) S Self-laminating label L Low-profile (extremely thin) label R Removable

▶ See pages 49 - 51 for a detailed material index.

## Specimen process marking

### Centrifuge / microcentrifuge labels

- Brady offers a wide range of Centrifuge, Eppendorf and PCR Labels.
- When applying a self-laminating label, we recommend you avoid touching the adhesive side of the label when wrapping it around a vial or tube, to ensure maximum adhesion.

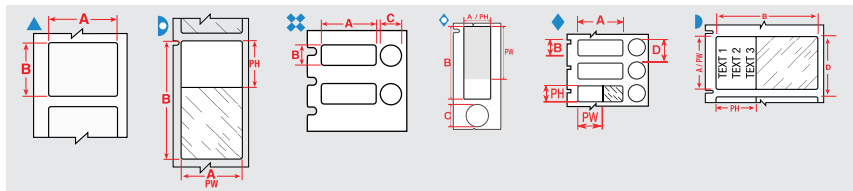

Labels are shown per vial / tube size and in order of label width.

The background colours in the Order Reference column represent the material colour.

Diagram	Material	Special Properties	Label Width A (mm)	Label Height B (mm)	Label Length B (m)	Diameter C (mm)	Printable Area Width PW (mm)	Printable Area Height PH (mm)	Order Reference	Printer Ribbon Series	Labels per Roll
<b>0.5 - 0.7 ml</b>											
▲	B-498	F R	9.53	25.40	-	-	-	-	M7-16-498	R6200	500
▲	B-499	F N A	9.53	25.40	-	-	-	-	M7-16-499	R4300	500
▷	B-461	F N A H S L	9.53	45.72	-	-	9.53	19.05	M7-73-461	R6200	250
▲	B-498	F R	12.70	19.05	-	-	-	-	BM-11-498	R6200	5000
▲	B-498	F R	12.70	19.05	-	-	-	-	M7-11-498	R6200	500
▲	B-499	F N A	12.70	19.05	-	-	-	-	M7-11-499	R4300	500
⊠	B-499	F A	25.40	9.53	-	9.53	-	-	M7-98-499	R4300, R6000HF, R6200, R6900	500
<b>0.6 ml</b>											
▲	B-499	F N A	22.86	12.70	-	-	-	-	M7-84-499	R4300, R6000F, R6200, R6900	500
<b>1.0 - 2.0 ml</b>											
▷	B-461	F N A H S L	15.24	38.10	-	-	15.24	33.00	M7-100-461	R6200	500
◇	B-461	F A H S L	15.24	41.28	-	12.70	15.24	30.00	M7-116-461	R6200	150
▷	B-461	F N A H S L	25.40	44.45	-	-	25.40	25.40	M7-106-461	R6200	250
◆	B-461	F A H S L	40.00	15.00	-	9.53	29.97	15.00	M7-101-461	R6200	250
<b>1.0 - 8.0 ml</b>											
▷	B-461	F N A H S L	15.24	41.28	-	-	15.24	25.40	M7-76-461	R6200	500
▷	B-461	F N A H S L	15.24	66.68	-	-	15.24	25.40	M7-86-461	R6200	100
▷	B-461	F N A H S L	25.40	66.68	-	-	25.40	25.40	M7-115-461	R6200	100
▲	B-490	F N H L	41.28	15.24	-	-	-	-	M7-76-490	R4300	500
▷	B-461	F N A H S L	66.68	25.40	-	-	25.40	25.40	BM-75-461	R6200	1000
<b>2.0 - 4.0 ml</b>											
▷	B-461	F N A H S L	15.24	48.26	-	-	15.24	40.00	M7-119-461	R6200	500
<b>50.0 ml</b>											
▷	B-427	F N S	19.05	38.10	-	-	19.05	12.70	BM-30-427	R4300	2500
▲	B-427	F N S	38.10	19.05	-	-	-	-	M7-30-427-AW	R4300	250

Order references beginning with "B" indicate bulk rolls. \*AW = All White / no transparent area.

### Slide labels

Brady offers labels specifically designed to identify slides and to resist exposure to harsh chemicals during the slide staining process. They perform well in the hematoxylin and eosin slide staining process and offer superior chemical resistance also useful in other laboratory contexts.

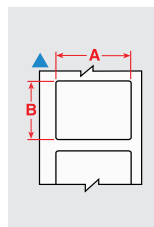

Diagram	Material	Special Properties	Label Width A (mm)	Label Height B (mm)	Order Reference	Printer Ribbon Series	Labels per Roll
▲	B-488	F A	19.05	22.86	M7-80-488	R4300	250
▲	B-488	F A	22.86	22.86	M7-97-488	R4300	250
▲	B-481	F H	22.86	22.86	M7-97-481	R6400	250

F Freezer environment N Liquid nitrogen environment A Autoclave environment H Hot water bath (100°C) S Self-laminating label L Low-profile (extremely thin) label R Removable

# Laboratory identification

## Specimen storage identification

### Cryo tubes & vials



- Brady offers a range of labels designed specifically to identify laboratory samples for cryo storage.
- These labels can be applied to room temperature or to already frozen samples, albeit with a small overlap.
- The label will remain legible and will stick to the sample container during processing, even when exposed to extreme heat or chemicals like DMSO, Xylene and Ethanol, ensuring secure sample identification in the most challenging laboratory conditions.

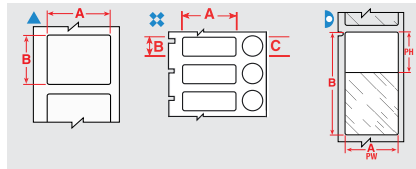

Labels are shown per vial / tube size and in order of label width.

The background colours in the Order Reference column represent the material colour.

Diagram	Material	Special Properties	Label Width A (mm)	Label Height B (mm)	Diameter C (mm)	Printable Area Width PW (mm)	Printable Area Height PH (mm)	Order Reference	Printer Ribbon Series	Labels per Roll
<b>0.3 ml Straw</b>										
▲	B-492	F N H L	25.40	25.40	-	-	-	M7-19-492	R6400	250
<b>0.5 - 0.7 ml</b>										
▲	B-499	F N A	12.70	19.05	-	-	-	M7-11-499	R4300	500
▲	B-492	F N H L	25.40	9.53	-	-	-	M7-16-492	R6400	500
⊞	B-499	F A	25.40	9.53	9.53	-	-	M7-98-499	R4300	500
<b>0.6 ml</b>										
▲	B-499	F N A	22.86	12.70	-	-	-	M7-84-499	R4300, R4500, R4900, R6000HF, R6200	500
<b>1.0 - 2.0 ml</b>										
⊞	B-492	F H L	25.40	12.70	9.53	-	-	M7-118-492	R6400	500
<b>1.0 - 8.0 ml</b>										
▲	B-490	F N H L	41.28	15.24	-	-	-	M7-76-490	R4300	500
▲	B-492	F N H L	48.26	25.40	-	-	-	M7-78-492	R6400	250
▶	B-461	F N A H S L	66.68	25.40	-	25.40	25.40	BM-75-461	R6200	1000
<b>12.0 - 24.0 ml</b>										
▲	B-498	F R	12.70	38.10	-	-	-	BM-29-498	R6200	5000
▲	B-499	F N A	12.70	38.10	-	-	-	M7-29-499	R6200	500
▲	B-498	F R	38.10	12.70	-	-	-	M7-29-498	R6200	500
<b>50.0 ml</b>										
▲	B-492	F N H L	25.40	12.70	-	-	-	M7-17-492	R6400	500

Order references beginning with "B" indicate bulk rolls.



### Tissue cassette labels

- Tissue cassettes are often re-identified when labs collect samples from various biorepositories. Typically, each laboratory has its own unique way of identifying samples, which creates a need to re-identify samples in a common way.
- Brady B-498 post-process labels offer customers the optimal way to organise these specimens and conduct further studies. These labels can be applied directly onto the cassettes, on pure paraffin wax and on top of another label or identifier.

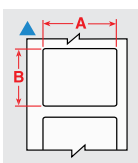

Diagram	Material	Special Properties	Label Width A (mm)	Label Height B (mm)	Order Reference	Printer Ribbon Series	Labels per Roll
▲	B-498	F R	6.35	19.05	M7-10-498	R6200	750
▲	B-498	F R	12.70	12.70	M7-7-498	R6200	500
▲	B-498	F R	12.70	19.05	BM-11-498	R6200	5000
▲	B-498	F R	12.70	19.05	M7-11-498	R6200	500
▲	B-498	F R	19.05	25.40	BM-18-498	R6200	2500
▲	B-498	F R	19.05	25.40	M7-18-498	R6200	250
▲	B-498	F R	25.40	12.70	M7-17-498	R6200	500

Order references beginning with "B" indicate bulk rolls.

F Freezer environment N Liquid nitrogen environment A Autoclave environment H Hot water bath (100°C) S Self-laminating label L Low-profile (extremely thin) label R Removable

## Specimen storage identification

### Well plate labels

When total tracking of all sample collections is required then Brady has a solution for Well plate identification. Our well plate labels guarantee crystal clear text and barcoding for most lab environments.

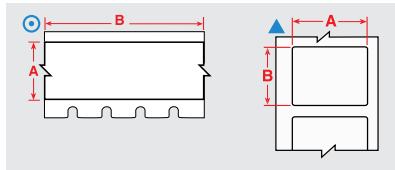

Labels are shown in order of label width.

The background colours in the Order Reference column represent the material colour.

Diagram	Material	Special Properties	Label Width A (mm)	Label Height B (mm)	Label Length B (m)	Order Reference	Printer Ribbon Series	Labels per Roll
⊙	B-498	F	6.10	-	9.14	M7C-240-498	R6200	1
⊙	B-498	F	6.10	-	83.82	BM7C-240-498	R6200	1
▲	B-498	F R	6.35	19.05	-	M7-10-498	R6200	750
⊙	B-498	F	8.08	-	9.14	M7C-318-498	R6200	1
⊙	B-498	F	9.53	-	9.14	M7C-375-498	R6200	1
⊙	B-498	F	9.53	-	83.82	BMC-375-498	R6200	1
⊙	B-498	F R	12.70	-	9.14	M7C-500-498	R6200	1
⊙	B-595	F	12.70	-	15.24	M7C-500-595-BK	R4400-WT	1
⊙	B-595	F	12.70	-	15.24	M7C-500-595-BL	R6000HF, R4400-WT	1
⊙	B-595	F	12.70	-	15.24	M7C-500-595-BR	R6000HF, R4400-WT	1
⊙	B-595	F	12.70	-	15.24	M7C-500-595-CL	R6000HF, R4400-WT	1
⊙	B-595	F	12.70	-	15.24	M7C-500-595-GD	R6000HF, R4400-WT	1
⊙	B-595	F	12.70	-	15.24	M7C-500-595-GN	R6000HF, R4400-WT	1
⊙	B-595	F	12.70	-	15.24	M7C-500-595-GY	R6000HF, R4400-WT	1
⊙	B-595	F	12.70	-	15.24	M7C-500-595-LB	R6000HF, R4400-WT	1
⊙	B-595	F	12.70	-	15.24	M7C-500-595-OC	R6000HF, R4400-WT	1
⊙	B-595	F	12.70	-	15.24	M7C-500-595-OR	R6000HF, R4400-WT	1
⊙	B-595	F	12.70	-	15.24	M7C-500-595-PK	R6000HF, R4400-WT	1
⊙	B-595	F	12.70	-	15.24	M7C-500-595-PL	R6000HF, R4400-WT	1
⊙	B-595	F	12.70	-	15.24	M7C-500-595-RD	R6000HF, R4400-WT	1
⊙	B-595	F	12.70	-	15.24	M7C-500-595-SB	R6000HF, R4400-WT	1
⊙	B-595	F	12.70	-	15.24	M7C-500-595-TN	R6000HF, R4400-WT	1
⊙	B-595	F	12.70	-	15.24	M7C-500-595-WT	R6000HF	1
⊙	B-595	F	12.70	-	15.24	M7C-500-595-YL	R6000HF, R4400-WT	1
⊙	B-430	F A H	12.70	-	15.24	M7C-500-430	R6000HF	1
▲	B-423	F A H	12.70	12.70	-	BM-7-423	R6000HF	5000
▲	B-499	F N A	12.70	12.70	-	M7-7-499	R4300	500
▲	B-498	F R	12.70	12.70	-	M7-7-498	R6200	500
▲	B-423	F A H	12.70	12.70	-	M7-7-423	R6000HF	500
▲	B-499	F N A	12.70	19.05	-	BM-11-499	R4300, R6000HF	5000
▲	B-498	F R	12.70	38.10	-	BM-29-498	R6200	5000
▲	B-499	F N A	12.70	38.10	-	M7-29-499	R6200	500
▲	B-499	F N A	15.00	9.00	-	M7-67-499-YL	R4300	750
▲	B-499	F N A	16.00	5.00	-	M7-41-499-YL	R4300	750
▲	B-498	F R	19.05	25.40	-	BM-18-498	R6200	2500
▲	B-499	F N A	19.05	25.40	-	M7-18-499	R4300	250
▲	B-498	F R	19.05	25.40	-	M7-18-498	R6200	250
▲	B-499	F N A	19.05	38.10	-	M7-30-499	R4300	250
▲	B-498	F R	19.05	38.10	-	M7-30-498	R6200	250
⊙	B-499	F N A	25.40	-	9.14	M7C-1000-499	R4300, R6000HF, R6200	1
⊙	B-498	F	25.40	-	9.14	M7C-1000-498	R6200	1
⊙	B-595	F	25.40	-	15.24	M7C-1000-595-BK	R4400-WT	1
⊙	B-595	F	25.40	-	15.24	M7C-1000-595-BL	R6000HF, R4400-WT	1
⊙	B-595	F	25.40	-	15.24	M7C-1000-595-BR	R6000HF, R4400-WT	1
⊙	B-595	F	25.40	-	15.24	M7C-1000-595-CL	R6000HF, R4400-WT	1
⊙	B-595	F	25.40	-	15.24	M7C-1000-595-GD	R6000HF, R4400-WT	1

Order references beginning with "B" indicate bulk rolls.

>>



# Laboratory identification

## Specimen storage identification



### Well plate labels (Continued)

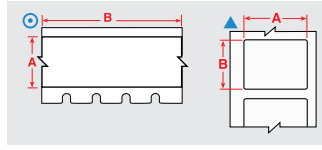

Labels are shown in order of label width.

The background colours in the Order Reference column represent the material colour.

Diagram	Material	Special Properties	Label Width A (mm)	Label Height B (mm)	Label Length B (m)	Order Reference	Printer Ribbon Series	Labels per Roll
⊙	B-595	F	25.40	-	15.24	M7C-1000-595-GN	R6000HF, R4400-WT	1
⊙	B-595	F	25.40	-	15.24	M7C-1000-595-GY	R6000HF, R4400-WT	1
⊙	B-595	F	25.40	-	15.24	M7C-1000-595-LB	R6000HF, R4400-WT	1
⊙	B-595	F	25.40	-	15.24	M7C-1000-595-OC	R6000HF, R4400-WT	1
⊙	B-595	F	25.40	-	15.24	M7C-1000-595-OR	R6000HF, R4400-WT	1
⊙	B-595	F	25.40	-	15.24	M7C-1000-595-PK	R6000HF, R4400-WT	1
⊙	B-595	F	25.40	-	15.24	M7C-1000-595-PL	R6000HF, R4400-WT	1
⊙	B-595	F	25.40	-	15.24	M7C-1000-595-RD	R6000HF, R4400-WT	1
⊙	B-595	F	25.40	-	15.24	M7C-1000-595-SB	R6000HF, R4400-WT	1
⊙	B-595	F	25.40	-	15.24	M7C-1000-595-TN	R6000HF, R4400-WT	1
⊙	B-595	F	25.40	-	15.24	M7C-1000-595-WT	R6000HF	1
⊙	B-595	F	25.40	-	15.24	M7C-1000-595-YL	R6000HF, R4400-WT	1
▲	B-423	F A H	25.40	4.75	-	M7-14-423	R6000HF	750
▲	B-423	F A H	25.40	6.99	-	M7-15-423	R6000HF	750
▲	B-498	F R	25.40	12.70	-	M7-17-498	R6200	500
▲	B-430	F A H	25.40	12.70	-	M7-17-430	R6000HF	500
▲	B-423	F A H	25.40	12.70	-	M7-17-423	R6000HF	500
▲	B-498	F	25.40	25.40	-	BM-19-498	R6200	2500
▲	B-499	F N A	25.40	25.40	-	M7-19-499	R4300	250
▲	B-498	F R	25.40	25.40	-	M7-19-498	R6200	250
▲	B-499	F N A	25.40	38.10	-	M7-31-499	R4300, R6000HF, R6200	250
▲	B-498	F R	25.40	38.10	-	M7-31-498	R6200	250
▲	B-423	F A H	25.40	50.80	-	M7-20-423	R6000HF	100
▲	B-499	F N A	38.10	6.35	-	M7-28-499	R4300, R4500, R4900, R6000HF, R6200	750
▲	B-498	F R	38.10	12.70	-	M7-29-498	R6200	500
▲	B-423	F A H	38.10	25.40	-	M7-31-423	R6000HF	250
▲	B-498	F R	38.10	38.10	-	M7-32-498	R6200	250
⊙	B-499	F N A	48.26	-	9.14	M7C-1900-499	R4300, R6000HF, R6200	1
⊙	B-498	F	48.26	-	9.14	M7C-1900-498	R6200	1
▲	B-499	F N A	48.26	6.35	-	M7-81-499	R4300	750
▲	B-488	F A	48.26	6.35	-	M7-81-488	R4300	750
▲	B-499	F N A	48.26	25.40	-	M7-78-499	R4300	250
▲	B-423	F A H	50.80	6.35	-	M7-2-423	R6000HF	100
▲	B-423	F A H	50.80	25.40	-	BM-20-423	R6000HF	1000
▲	B-423	F A H	76.20	25.40	-	M7-22-423	R6000HF	100

Order references beginning with "B" indicate bulk rolls.

### Bottle tamper seal labels

Brady's bottle seal identification provides tracking information with the added feature of security. These labelling materials are designed to fracture easily in order to show signs of sample tampering and to prevent one-piece label removal.



Diagram	Material	Special Properties	Label Width A (mm)	Label Height B (mm)	Order Reference	Printer Ribbon Series	Labels per Roll
▲	B-351	F	25.40	12.70	M7-17-351	R6000HF	500
▲	B-351	F	25.40	50.80	M7-20-351	R6000HF	100
▲	B-351	F	38.10	25.40	M7-31-351	R6000HF	250
▲	B-351	F	76.20	48.26	M7-37-351	R6000HF	100

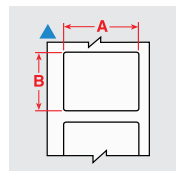

## Lean lab identification

### Bottles / flasks & dishes

Brady's labels for bottles, flasks and dishes are flexible, which makes them easy to apply to curved containers and remain attached and legible, even after being subjected to freezing, liquid nitrogen and heat.

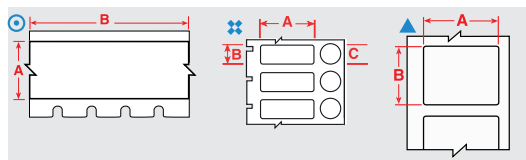

Labels are shown in order of label width.

The background colours in the Order Reference column represent the material colour.

Diagram	Material	Special Properties	Label Width A (mm)	Label Height B (mm)	Label Length B (m)	Diameter C (mm)	Order Reference	Printer Ribbon Series	Labels per Roll
⊙	B-430	F A H	12.70	-	15.24	-	M7C-500-430	R6000HF	1
▲	B-423	F A H	12.70	12.70	-	-	BM-7-423	R6000HF	5000
▲	B-423	F A H	12.70	12.70	-	-	M7-7-423	R6000HF	500
▲	B-498	F R	12.70	38.10	-	-	BM-29-498	R6200	5000
▲	B-499	F N A	12.70	38.10	-	-	M7-29-499	R6200	500
▲	B-499	F N A	19.05	38.10	-	-	M7-30-499	R4300	250
▲	B-423	F A H	25.40	4.75	-	-	M7-14-423	R6000HF	750
▲	B-423	F A H	25.40	6.99	-	-	M7-15-423	R6000HF	750
▲	B-492	F N H L	25.40	9.53	-	-	M7-16-492	R6400	500
▲	B-498	F R	25.40	12.70	-	-	M7-17-498	R6200	500
▲	B-492	F N H L	25.40	12.70	-	-	M7-17-492	R6400	500
▲	B-430	F A H	25.40	12.70	-	-	M7-17-430	R6000HF	500
▲	B-423	F A H	25.40	12.70	-	-	M7-17-423	R6000HF	500
⊗	B-492	F H L	25.40	12.70	-	9.53	M7-118-492	R6400	500
▲	B-492	F N H L	25.40	25.40	-	-	M7-19-492	R6400	250
▲	B-423	F A H	25.40	50.80	-	-	M7-20-423	R6000HF	100
▲	B-498	F R	38.10	12.70	-	-	M7-29-498	R6200	500
▲	B-427	F N S	38.10	19.05	-	-	M7-30-427-AW	R4300, R4400, R6700	250
▲	B-490	F N H L	41.28	15.24	-	-	M7-76-490	R4300	500
▲	B-499	F N A	48.26	25.40	-	-	M7-78-499	R4300	250
▲	B-492	F N H L	48.26	25.40	-	-	M7-78-492	R6400	250
▲	B-423	F A H	50.80	25.40	-	-	BM-20-423	R6000HF	1000
▲	B-423	F A H	76.20	25.40	-	-	M7-22-423	R6000HF	100

Order references beginning with "B" indicate bulk rolls. \*Order references ending with "AW" indicate all white labels with no clear area.

## Lean lab identification



### General lab equipment labels

With proper identification, time spent looking for the right sample or tool can be invested in what really matters. Brady offers a range of materials suitable for identifying drawers, cabinets, shelves, storage units and laboratory equipment.

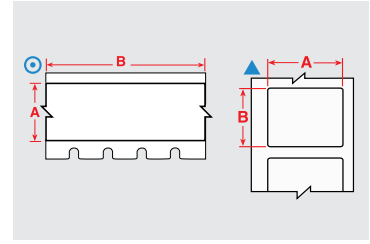

Diagram	Material	Special Properties	Label Width A (mm)	Label Height B (mm)	Label Length B (m)	Order Reference	Printer Ribbon Series	Labels per Roll
⊙	B-430	F A H	9.53	-	15.24	M7C-375-430	R6000HF	1
▲	B-423		9.53	9.53	-	M7-3-423	R6000HF	500
▲	B-423		10.16	10.16	-	M7-4-423	R6000HF	500
⊙	B-595	F	12.70	-	15.24	M7C-500-595-BK	R4400-WT	1
⊙	B-595	F	12.70	-	15.24	M7C-500-595-BL	R6000HF, R4400-WT	1
⊙	B-595	F	12.70	-	15.24	M7C-500-595-CL	R6000HF, R4400-WT	1
⊙	B-595	F	12.70	-	15.24	M7C-500-595-GN	R6000HF, R4400-WT	1
⊙	B-595	F	12.70	-	15.24	M7C-500-595-OR	R6000HF, R4400-WT	1
⊙	B-595	F	12.70	-	15.24	M7C-500-595-RD	R6000HF, R4400-WT	1
⊙	B-595	F	12.70	-	15.24	M7C-500-595-WT	R6000HF	1
⊙	B-595	F	12.70	-	15.24	M7C-500-595-YL	R6000HF, R4400-WT	1
⊙	B-430	F A H	12.70	-	15.24	M7C-500-430	R6000HF	1
⊙	B-423		12.70	-	15.24	M7C-500-423	R6000HF	1
▲	B-423	F A H	12.70	12.70	-	BM-7-423	R6000HF	5000
▲	B-423	F A H	12.70	12.70	-	M7-7-423	R6000HF	500
⊙	B-595	F	25.40	-	15.24	M7C-1000-595-BK	R4400-WT	1
⊙	B-595	F	25.40	-	15.24	M7C-1000-595-BL	R6000HF, R4400-WT	1
⊙	B-595	F	25.40	-	15.24	M7C-1000-595-CL	R6000HF, R4400-WT	1
⊙	B-595	F	25.40	-	15.24	M7C-1000-595-GN	R6000HF, R4400-WT	1
⊙	B-595	F	25.40	-	15.24	M7C-1000-595-OR	R6000HF, R4400-WT	1
⊙	B-595	F	25.40	-	15.24	M7C-1000-595-RD	R6000HF, R4400-WT	1
⊙	B-595	F	25.40	-	15.24	M7C-1000-595-WT	R6000HF	1
⊙	B-595	F	25.40	-	15.24	M7C-1000-595-YL	R6000HF, R4400-WT	1
⊙	B-430	F A H	25.40	-	15.24	M7C-1000-430	R6000HF	1
▲	B-423		25.40	9.53	-	BM-16-423	R6000HF	5000
▲	B-430		25.40	9.53	-	M7-16-430	R6000HF	500
▲	B-423		25.40	9.53	-	M7-16-423	R6000HF	500
▲	B-423		25.40	12.70	-	BM-17-423	R6000HF	5000
▲	B-430	F A H	25.40	12.70	-	M7-17-430	R6000HF	500
▲	B-423	F A H	25.40	12.70	-	M7-17-423	R6000HF	500
▲	B-423		25.40	25.40	-	BM-19-423	R6000HF	2500
▲	B-423		25.40	25.40	-	M7-19-423	R6000HF	250
▲	B-424	F	25.40	50.80	-	M7-20-424	R4300	100
▲	B-423	F A H	25.40	50.80	-	M7-20-423	R6000HF	100
▲	B-430		38.10	9.53	-	M7-45-430	R6000HF	500
▲	B-423		38.10	12.70	-	BM-29-423	R6000HF	5000
▲	B-423		38.10	12.70	-	M7-29-423	R6000HF	500
▲	B-423	F A H	38.10	25.40	-	M7-31-423	R6000HF	250
▲	B-423		38.10	38.10	-	M7-32-423	R6000HF	250
⊙	B-595	F	50.80	-	15.24	M7C-2000-595-BK	R4400-WT	1
⊙	B-595	F	50.80	-	15.24	M7C-2000-595-BL	R6000HF, R4400-WT	1
⊙	B-595	F	50.80	-	15.24	M7C-2000-595-CL	R6000HF, R4400-WT	1
⊙	B-595	F	50.80	-	15.24	M7C-2000-595-GN	R6000HF, R4400-WT	1
⊙	B-595	F	50.80	-	15.24	M7C-2000-595-OR	R6000HF, R4400-WT	1
⊙	B-595	F	50.80	-	15.24	M7C-2000-595-RD	R6000HF, R4400-WT	1
⊙	B-595	F	50.80	-	15.24	M7C-2000-595-WT	R6000HF	1
⊙	B-595	F	50.80	-	15.24	M7C-2000-595-YL	R6000HF, R4400-WT	1
⊙	B-430	F A H	50.80	-	15.24	M7C-1900-430	R6000HF	1
▲	B-424	F	50.80	25.40	-	BM-20-424	R4300	1000
▲	B-423	F A H	50.80	25.40	-	BM-20-423	R6000HF	1000

This section provides a quick reference to Brady materials listed throughout this brochure, including applications and regulatory compliance where applicable. For more detailed material attribute and performance information, please refer to the material's Technical Data Sheet, listed at [www.bradyeurope.com/tds](http://www.bradyeurope.com/tds).

Material	Finish	Colour	Temp (°C) (Tested for 30 days)		Properties & Applications	Approval/Compliance	
			Min.	Max.			
B-109	Polyethylene Tag	Matt	White	-40 °C	49 °C	White polyethylene tag material with matt finish. Excellent multi-purpose tag for identifying multiconductor cables, inventory, safety warning repair and work-in-processing manufacturing. Good weatherability, humidity resistance and legibility after solvent exposure.	–
B-342	Heat-shrink Polyolefin Sleeve	Matt	White	-55 °C	130.6 °C	3:1 ratio heat shrinkable wire marking sleeve that fits snugly around wires for identification and protection. Fade-resistant and flame retardant. Also available in yellow and black.	UL Recognised to UL224; SAE-AMS-DTL-23053/5 C (Class 1); SAE-AS-81531
B-348	Polyolefin	Matt	White	-55 °C	135 °C	Mass Transit Tag complies with minimal smoke and halogen emission requirements of the most strict underground norms for mass transit vehicles. The tag is a practical solution for mass transit manufacturers to identify thick cables and cable bundles.	–
B-351	Tamper-resistant Vinyl	Matt	White	-40 °C	80 °C	White vinyl material with matt finish. Tamper evident material fractures to show signs of product tampering and prevent one-piece removal.	–
B-362	Tamper-resistant Metallised Vinyl	Gloss	Silver	-70 °C	80 °C	Designed to fracture easily in order to show signs of product tampering and to prevent one-piece label removal. Use caution when removing from liner as material is fragile.	–
B-412	Polypropylene Tag	Matt	White	-40 °C	100 °C	White polypropylene tag material with matt finish. Offers high print legibility and high tensile strength.	–
B-414	Polyester	Matt	White	-40 °C	50 °C	Get a grip on your wire and cable identification – Brady and VELCRO® Brand have partnered to bring you BradyGrip™ Print-on Hook Material, an exclusive print-and-place material that can be easily applied, repositioned or removed.	–
B-417	Self-laminating Vinyl	Matt	White, Transparent	-40 °C	70 °C	Keep your wire identification secure with this self-laminating marker with extra-strong adhesive. The extra-strong adhesive makes these markers ideal for small-diameter wires. Features a white printable area and a clear tail that wraps around the marker.	UL Recognised to UL969 Labelling and Marking Standard when printed with the Brady Series R4300 and R7950 ribbons. See UL files MH62024 for specific details. Brady customers should specify at purchase if they require UL Recognised B-417 labels. Brady sells both UL Recognised B-417 labels and non-approved labels depending on customer requirements
B-422	Polyester	Gloss	White	-40 °C	100 °C	Designed to withstand solvent exposure. Used for component identification, barcoding, asset and inventory tracking.	UL Recognised; CSA Accepted
B-423	Polyester	Gloss	White	-70 °C	110 °C	Widely used for component identification, barcoding, asset and inventory tracking.	UL Recognised; CSA Accepted; AGA Approved; Halogen Free (DIN VDE 0472/part 815)
B-424	Paper	Matt	White	-40 °C	50 °C	White paper material with matt finish and smooth top coat finish for thermal transfer printing. Good contrast and smear resistance for thermal barcode printing. Used for general purpose labeling applications	–
B-425A	Polypropylene	Matt	White	-70 °C	80 °C	White polypropylene material stock with matt finish for thermal transfer printing or write-on applications. Excellent solvent resistance and print performance; not recommended for long-term outdoor use.	UL Recognised; CSA Accepted; Halogen Free (DIN VDE 0472/part 815)
B-427	Self-laminating Vinyl	Matt	White, Transparent	-40 °C	60 °C	Thermal transfer printable, self-laminating material. These labels have a printable area with a clear "tail" that wraps around the marker. The "tail" serves as overlaminates to protect the print. Superior resistance to abrasion, solvents, water, oil and dirt. Also available in grey, brown, green, yellow, blue, red, purple, orange.	UL Recognised to UL969 Labelling and Marking Standard when printed with the Brady Series R4300 and R6200 ribbons. See UL files MH17154 for specific details. Brady customers should specify at purchase if they require UL Recognised B-427 labels. Brady sells both UL Recognised B-427 labels and non-approved labels depending on customer requirements.
B-428	Metallised Polyester	Matt	Light Grey	-70 °C	120 °C	Thermal transfer printable metallised polyester with matt finish. Withstands solvents and variable temperatures. Excellent for serial and rating plate applications with name-plate quality and a metal-looking finish.	UL Recognised; CSA Accepted; Halogen Free (DIN VDE 0472/part 815)
B-430	Polyester	Gloss	Transparent	-70 °C	100 °C	Translucent, high performance polyester material with a glossy finish. Thermal transfer printable.	UL Recognised; CSA Accepted
B-437	Polyvinylfluoride	Matt	White	-70 °C	135 °C	Polyvinylfluoride label material with matt finish. Used in wire and cable identification applications where self-extinguishing features are required. This label material utilises an adhesive for heavy-duty applications and is available in continuous or die-cut formats. Excellent resistance to water, oil and other common fluids. Also available in yellow.	MIL-M-87958 Pressure Sensitive Adhesive Wire or Cable Marker and Identification specification



# Master material index

Material	Finish	Colour	Temp (°C) (Tested for 30 days)		Properties & Applications	Approval/Compliance	
			Min.	Max.			
B-459	Polyester	Matt	White	-40 °C	100 °C	White polyester thermal transfer printable material with matt finish. Designed for applications such as topside of printed circuit boards and rating plates that utilise high quality/density alphanumerics, barcodes and graphics.	UL Recognised; CSA Accepted
B-461	Self-laminating Polyester	Matt	White, Transparent	-196 °C	110 °C	Permanent adhesive; suitable for liquid nitrogen application if material is wrapped around itself, as in self-lamination; write-on capabilities. Temperature range increases to 121°C when used in autoclave process	–
B-472	Polyimide	Matt	White	-70 °C	100 °C	Cable and wire bundle applications and label applications where self-extinguishing properties are required	–
B-473	Static Dissipative Polyester	Gloss	White	-40 °C	120 °C	This material is constructed with a static dissipative adhesive, it is designed for printed circuit board and electronic component post-process labeling.	UL Recognised; CSA Accepted; Meets surface resistivity values in the recommended range for dissipative ESD packaging materials as defined by ANSI/ESD S541-2008 (between 10 <sup>4</sup> and 10 <sup>11</sup> ohms)
B-481	StainerBondz™ Polyester	Matt	White	-80 °C	130 °C	White polyester will remain resistant when exposed to xylene and other chemicals that are commonly used in the slide staining process	–
B-483A	Polyester	Gloss	White	-40 °C	120 °C	White polyester thermal transfer printable material with glossy finish and aggressive adhesive specifically designed for powder coated surfaces.	UL Recognised; CSA Accepted
B-483A / B-634	Polyester with Polyester Overlaminates	Gloss	White	-18 °C	54 °C	ToughStripe™ floor marking thermal transfer printable polyester with ultra-aggressive adhesive which allows for printable messages to be placed on the floor. The floor marking roll ships with a separate roll of B-634 Polyester Overlaminates to protect your legend. Ideal to create custom-printed floor labels. Available in white, yellow, red, orange, green, blue and black.	–
B-486B	Metallised Polyester	Matt	Light Grey	-40 °C	120 °C	Metallized polyester thermal transfer printable material, ideal for indoor product labeling, asset tracking and general ID on very rough surfaces.	UL Recognised; CSA Accepted
B-488	Polyester	Matt	White	-40 °C	145 °C	White polyester thermal transfer printable material, similar to B-423, but with matt finish. Widely used for component identification, barcoding, asset and inventory tracking.	UL Recognised; CSA Accepted
B-489A	Polyester	Matt	White	-40 °C	120 °C	White polyester thermal transfer printable material, similar to B-483, but with matt finish. Aggressive adhesive specifically designed for powder coated surfaces.	UL Recognised; CSA Accepted
B-490	FreezerBondz™ Polyester	Matt	White	-196 °C	130 °C	Can be applied to frozen surfaces including glass and polypropylene stored in liquid nitrogen, except for Vial Tops. Material must slightly overlap itself.	–
B-492	FreezerBondz™ Polyester	Matt	White	-196 °C	110 °C	Ultra thin; can label frosted/frozen (with overlap) or room temperature labels and lasts in liquid nitrogen and hot water baths	–
B-498	Vinyl Cloth	Semi-gloss	White	-40 °C	80 °C	White vinyl cloth label material with glossy finish. The adhesive and cloth backing give excellent holding power, while being repositionable and removing cleanly.	UL Recognised
B-499	Nylon Cloth	Matt	Black on White	-40 °C	90 °C	Nylon cloth material with matt finish. The adhesive allows labelling in environments with heat, cold, oil and dirt. Also available in yellow.	UL Recognised; CSA Accepted; Halogen Free (DIN VDE 0472/part 815) Approvals are for White material only
B-509	Magnetic Polyester	Matt	White	-18 °C	70 °C	Magnetic Back Polyester is used for temporary, reusable and movable signs	–
B-526	Phosphorescent Polyester	Gloss	Photoluminescent Green	-40 °C	60 °C	BradyGlo™ High Intensity laminate is designed to provide high adhesion and luminance for egress marking in low light areas in and along stairwells of public buildings, exit and directional signs, identification of fire alarms and extinguishers, low location egress pathway markings, and directional systems for escape or evacuation routes.	New York Local Law 26 RS 6-1 & 6-1A; City of New York, Department of Buildings MEA No. 467-06-M UV: 46-9-7
B-529	Polypropylene	Gloss	White	-40 °C	100 °C	Brady's economy polypropylene tape is for use indoors on smooth, flat surfaces.	–
B-530	Tamper-resistant Vinyl	Gloss	White	-40 °C	90 °C	Brady's tamper resistant tape destructs into tiny fragments when tampered with.	–
B-549	Polyester	Gloss	White	-40 °C	100 °C	Flexible, dimensionally stable, low temperature, pressure sensitive adhesive tape for permanent application. Adhesive can be applied at temperatures down to -10°F (-23°C).	–
B-569	Polyester	Gloss	Green	-40 °C	100 °C	Designed for use on stainless steel pipes in harsh environments such as the Pulp and Paper Industry	–
B-581	Vinyl	Gloss	White	-40 °C	82 °C	Only indoor use, where frequent repositioning is required	–
B-582	Phosphorescent Polyester	Gloss	Photoluminescent Green	-40 °C	80 °C	Phosphorescent Polyester is used for exit and directional signs, identification of fire alarms and extinguishers, low location egress pathway markings, and directional systems for escape or evacuations routes.	ASTM E-2072-00 / ASTM E-2073-00; ASTM E-162; ASTM E-648; ASTM E-662; IMO Resolution A.752(18); ISO/CD 15370; Marine Safety Committee MSC.27(61); DIN 67510 (Parts 1 - 4) Meets OSHA 1910.37

Material	Finish	Colour	Temp (°C) (Tested for 30 days)		Properties & Applications	Approval/Compliance
			Min.	Max.		
B-584	Reflective Tape	Gloss	Orange	-40 °C	70 °C	Suitable for outdoor use. Also available in silver and yellow. —
B-595	Vinyl	Gloss	White	-40 °C	82 °C	Durable, low-shrink vinyl with our most aggressive adhesive. Conforms to irregular, curved, rough and highly textured surfaces (painted cinder blocks, uneven wood, textured plastics, paper-jacketed pipes, powder-coated surfaces). Adheres to "difficult" low-surface energy items (PVC piping, blow-moulded equipment cases, ABS plastics, recycled plastics). Available in a wide range of colours. BS5609:1986 Section 2 and section 3
B-642	Polyvinylfluoride	Matt	White, Transparent	-70 °C	120 °C	Applications requiring self-extinguishing identification. Self-laminating, wire, cable and laboratory vial marking. Excellent abrasion and smudge resistance. —
B-717	Polyimide	Gloss	White	-70 °C	300 °C	White polyimide material with glossy finish and ultra-durable adhesive. Used in printed circuit board and electronic component pre-process labelling. Designed for use with extreme wash protocol and cleaning chemicals. Surface resistivity values in the recommended range for dissipative ESD packing materials. UL Recognised; Meets the requirements of ANSI/ESD S541-2008 (between 10 <sup>4</sup> and 10 <sup>11</sup> ohms) for dissipative ESD packaging materials; Meets the performance requirements of MIL-STD-202G, Method 215K
B-718	Polyimide	Gloss	White	-70 °C	300 °C	White polyimide material, low profile (1 mil thickness), with glossy finish and ultra-durable adhesive. Used in printed circuit board and electronic component pre-process labelling. Designed for use with extreme wash protocol and cleaning chemicals. Surface resistivity values in the recommended range for dissipative ESD packing materials. UL Recognised; Meets the requirements of ANSI/ESD S541-2008 (between 10 <sup>4</sup> and 10 <sup>11</sup> ohms) for dissipative ESD packaging materials; Meets the performance requirements of MIL-STD-202G, Method 215K
B-719	Polyimide	Matt	White	-70 °C	300 °C	White polyimide material with matt finish and ultra-durable adhesive. Used in printed circuit board and electronic component pre-process labelling. Designed for use with extreme wash protocol and cleaning chemicals. Surface resistivity values in the recommended range for dissipative ESD packing materials. UL Recognised; Meets the requirements of ANSI/ESD S541-2008 (between 10 <sup>4</sup> and 10 <sup>11</sup> ohms) for dissipative ESD packaging materials; Meets the performance requirements of MIL-STD-202G, Method 215K
B-724	Polyimide	Matt	Amber	-70 °C	300 °C	Amber polyimide material with matt finish and ultra-durable adhesive. Used in printed circuit board and electronic component pre-process labelling. Designed for use with extreme wash protocol and cleaning chemicals. Meets the performance requirements of MIL-STD-202G, Notice 12, Method 215K; Meets the requirements of SAE AS81531 Marking of Electrical Insulating Material
B-727	Polyimide	Gloss	White	-70 °C	300 °C	White polyimide material with glossy finish and ultra-durable adhesive. Used in printed circuit board and electronic component pre-process labelling. Designed for use with extreme wash protocol and cleaning chemicals. UL Recognised; Meets the performance requirements of MIL-STD-202G, Notice 12, Method 215K; Dibutyltin and Dioctyltin free.
B-7593	Polyethylene Foam Laminate Polyester	Gloss	White, Yellow, Red, Green, Silver, Black	-40 °C	100 °C	EPREP (Engraved Panel REplacement labels) are designed for patch panel identification in identifying external push-buttons, switches and internal connection points. Also available in black, green, red, silver and yellow. —
B-7598	Polyester Tag	Gloss	White, Yellow, Red, Green, Silver, Black, Blue	-40 °C	100 °C	A general identification polyester tag for cables exposed to extreme conditions. Up to 10 years outdoor durability. Also available in black, blue, green, red, silver and yellow. Parts supplied in White, Black or Silver are Halogen Free as per IEC 61249-2-21 (2003-11)
B-7599	Polyethylene Tag	Matt	Yellow	-40 °C	50 °C	White polyethylene tag material. Rapido™ Wiremarking Sleeves are fast and easy to apply. Simply squeeze the edges of the material together, thread your wire through the holes and pull away the wire to release the marker. —
B-7641	Heat-shrink Polyolefin Sleeve	Matt	White	-55 °C	105 °C	2:1 ratio heat shrinkable, zero halogen wire marking sleeves. The wire marking sleeves offer outstanding fire safety properties and minimal smoke emission. Also available in yellow. BS-6853 (1999) Vehicle Category 1A; EN-45545-2, requirement 24, Vehicle Category HL3; Zero Halogen
B-7643	Thermoplastic Polyether Polyurethane	Matt	White, Yellow	-40 °C	90 °C	Thermal transfer and dot matrix printable wire and cable bundle tag for harsh environments. Low halogen material. Also available in black, orange, red and yellow. Halogen free per IEC 61249-2-21 (2003-11), Adherence: SAE-AS81531-1998, Flame retardant: MIL-STD-202G
B-7696	Vinyl Tag	Gloss	White, Yellow	-40 °C	70 °C	Brady DuraSleeve® printable inserts create a durable legend. The rigid construction of the DuraSleeve wire marking system provides inserts that can easily be inserted into a clean carrier. The legend can be changed before or after termination. Also available in yellow. UL94 V0
B-7697	Polyester	Matt	White	-40 °C	120 °C	Brady DuraSleeve® printable polyester wire marking inserts. The rigid construction of the DuraSleeve system provides inserts that can easily be inserted into a clean carrier. —
B-854	Metal Detectable Polyester	Matt	White	-40 °C	110 °C	Tough against harsh washdown environments; metal detectable. Also available in yellow. —
B-855	Polyester	Matt	White	-40 °C	110 °C	Tough against harsh washdown environments. Also available in yellow. —

## Design any label with Brady Workstation apps

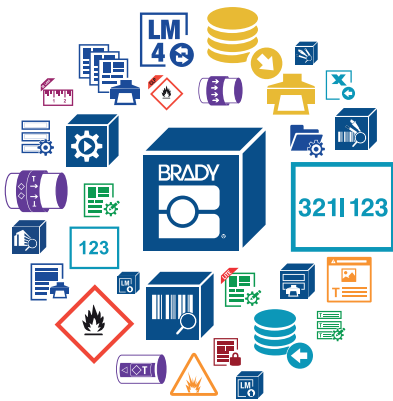

Brady Workstation offers professional, intuitive apps to design quality product and cable labels and safety signs. Label design becomes easier, faster and quickly adaptable to new label norms thanks to centralised updates.

### Select the apps you need

Simply select the apps you need, download the 30-day trial and purchase when satisfied.

▶ Try it today! Discover Brady Workstation at [www.bradyeurope.com/workstation](http://www.bradyeurope.com/workstation) or download at [workstation.bradyid.com](http://workstation.bradyid.com).

## Brady Workstation Express Label App

Access files faster. Anywhere you work.

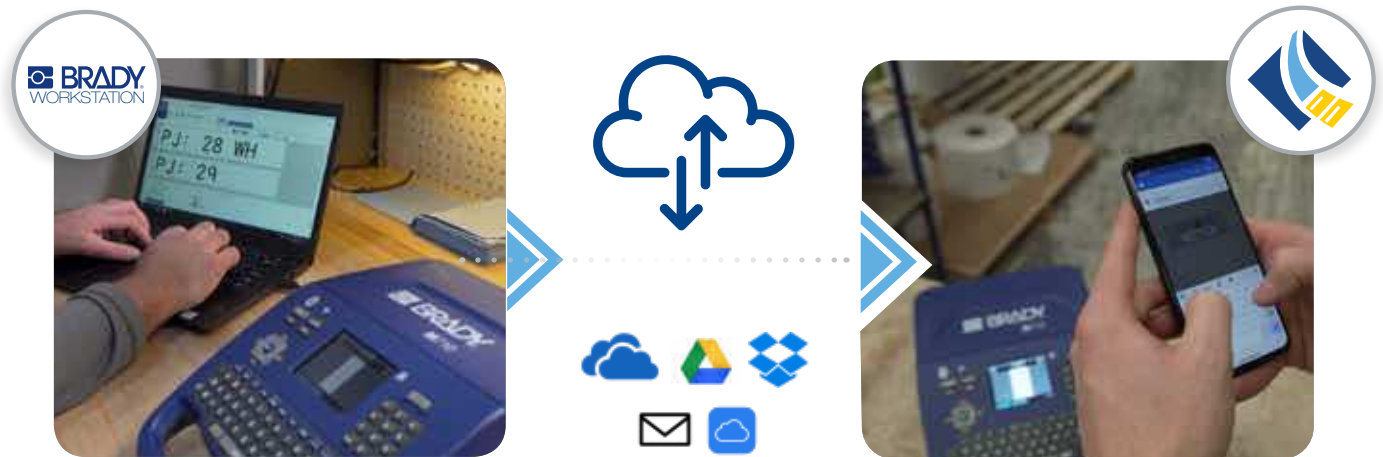

Label file created in the office

Labels pushed to the cloud

Labels printed in the field

- ▶ 20+ barcode types
- ▶ Microsoft Excel data imports
- ▶ Accurate print preview
- ▶ 85+ fonts
- ▶ Label sequencing
- ▶ Real-time printer status
- ▶ 1,400+ symbols
- ▶ Label saving and sharing
- ▶ 30+ Supported languages

▶ Get the free app from Apple App Store or Google Play (Search “Brady Express Labels”)



Specifications	
Print Technology	Thermal Transfer
Print Resolution (dpi)	300
Print Speed (mm/sec)	76.20
Colour Capability	Monocolour
Continuous vs Die-cut Labels	Continuous and Die-cut
Max. Label Width (mm)	50.80
Max. Print Length (mm)	1016.00
Recommended Usage per Day	1000
Connectivity Options	Standalone Use USB Bluetooth on selected models WiFi on selected models
Phones & Tablets Supported	Android devices with Android OS 6+ iPhone with iOS 10+ Only applicable to WiFi and Bluetooth models.
Software Compatibility	Brady Workstation Express Labels App
Bar Code Type	QR Code Data Matrix Code 128 Code 39 EAN-8 EAN-13 Interleaved 2 of 5 UPC-A UPC-E More through software
Built-in Symbols	500+
Physical Properties	
Width x Height x Depth (mm)	240.03 x 345.20 x 116.75
Weight (kg)	2.45
On Screen Indicators	Battery Life Ribbon and label part number recognition Ribbon Remaining Supply Remaining
Cutter	Auto Cutter
Warranty	2 years
Drop Test	Resistant to 1.2 metre drops Sand & Dust





## Printers



▶ For more information about Brady Workstation App And Brady Express Label App, see page 52.

The Basic Suite is included with every printer, all you need to do is download it. [Workstation.BradyID.com/Free](http://Workstation.BradyID.com/Free)

Order Reference	Art. No.	Description
M710-AZ-PWID	317818	M710 AZERTY EU + BWS PWID Suite
M710-WB-AZ-PWID	317819	M710 AZERTY EU Wifi, BT + BWS PWID Suite
M710-WB-AZ-SFID	317827	M710 AZERTY EU Wifi, BT + BWS SFID Suite
M710-WB-CYR-PWID	317820	M710 CYRILLIC EU Wifi, BT + BWS PWID Suite
M710-WB-CYR-SFID	317828	M710 CYRILLIC Wifi, BT + BWS SFID Suite
M710-AZERTY-EU	317814	M710 Label Printer AZERTY
M710-WB-AZERTY-EU	317815	M710 Label Printer AZERTY, Wifi, BT
M710-WB-CYRILLIC	317817	M710 Label Printer Cyrillic with Wifi and BT
M710-QWERTY-EU	317810	M710 Label Printer QWERTY EU
M710-WB-QWERTY-EU	317811	M710 Label Printer QWERTY EU with Wifi and BT
M710-QWERTY-UK	317812	M710 Label Printer QWERTY UK
M710-WB-QWERTY-UK	317813	M710 Label Printer QWERTY UK with Wifi and BT
M710-WB-QWERTZ	317816	M710 Label Printer QWERTZ with Wifi and BT
M710-QY-EU-PWID	317821	M710 QWERTY EU + BWS PWID Suite
M710-QY-EU-SFID	317829	M710 QWERTY EU + BWS SFID Suite
M710-WB-QY-EU-PWID	317822	M710 QWERTY EU Wifi, BT + BWS PWID Suite
M710-WB-QY-EU-SFID	317830	M710 QWERTY EU Wifi, BT + BWS SFID Suite
M710-QY-UK-PWID	317823	M710 QWERTY UK + BWS PWID Suite
M710-QY-UK-SFID	317831	M710 QWERTY UK + BWS SFID Suite
M710-WB-QY-UK-PWID	317824	M710 QWERTY UK Wifi, BT + BWS PWID Suite
M710-WB-QY-UK-SFID	317832	M710 QWERTY UK Wifi, BT + BWS SFID Suite
M710-US	317834	M710 Qwerty US Label Printer
M710-WB-US	317835	M710 Qwerty US Label Printer with Wifi and BT
M710-WB-QZ-PWID	317825	M710 QWERTZ EU Wifi, BT + BWS PWID Suite
M710-WB-QZ-SFID	317833	M710 QWERTZ EU Wifi, BT + BWS SFID Suite
M710-AZ-SFID	317826	MP71 AZERTY EU + BWS SFID Suite

This printer ships in a hard case holding a USB cable, a quick start guide, a product USB (with product info and Windows driver), a Li-Ion Rechargeable Battery, an AC Adapter, a Brady Workstation Design Software, a Media Adapter, a roll of M7C-1000-595-WT and an M7-R6000 ribbon

## Accessories

Hard case



Cleaning kit



Li-Ion Battery



Art. No.	Description
114886	Cleaning Kit
175664	Hard Case M710 Label Printer
147998	Media Adaptor for high-end portable printer
150619	Protective softbag for portable printers
175673	Rechargeable Lithium-ion Battery for M610/M710 printer
175674	Rechargeable NiMH Battery for M610/M710 printers
175665	USB-C to USB Type A Cord

## 2 year warranty on all Brady portable printers

Brady offers a 2 year warranty on every Brady Mobile Printer sold. This manufacturer's warranty is completely free and highlights Brady's commitment to quality and on-the-job reliability.

Flash this QR Code to access to all the details about the Brady warranty.

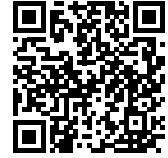

## What if you want more extensive support ?

Brady offers Assist Base, Assist Field and Assist Custom service contracts which include priority assistance for 1, 3 or 5 years to guarantee continued support and the ultimate printer reliability, even in demanding working environments. These agreements also include many great extras versus our free, standard 2 year warranty, such as: spare parts, a solution within 2 business days, free annual preventive maintenance, repair transportation costs, priority access to the technical service team or even a specialist at your premises. Get all of these extra assurances for less than the cost of one flat fee repair!

## Our training and setup service

- **Brady Setup Base** : Stress free installation of your Brady printer and software by screensharing. We help you produce your first labels.
- **Brady Setup Field** : Stress free installation of your Brady printer and software by a Brady specialist at your premises. We help you produce your first labels.
- **Brady Training Half/Whole day** : Hands-on training by a Brady specialist at your premises.



**Please contact us for additional information!**



**Africa**

Randburg, South Africa  
Tel.: +27 11 704 3295  
Email: africa@bradycorp.com

**Benelux**

Zele, Belgium  
Tel.: +32 (0) 52 45 78 11  
Email: benelux@bradycorp.com

**Central & Eastern Europe**

Bratislava, Slovakia  
Tel.: +421 2 3300 4800  
Email: central\_europe@bradycorp.com

**Denmark**

Odense  
Tel.: +45 66 14 44 00  
Email: denmark@bradycorp.com

**France**

Roncq  
Tel.: +33 (0) 3 20 76 94 48  
Email: france@bradycorp.com

**Germany, Austria & Switzerland**

Egelsbach, Germany  
Tel.: +49 (0) 6103 7598 660  
Email: germany@bradycorp.com

**Hungary**

Budaörs  
Tel.: +36 23 500 275  
Email: central\_europe@bradycorp.com

**Italy**

Gorgonzola  
Tel.: +39 02 26 00 00 22  
Email: italy@bradycorp.com

**Middle East FZE**

Dubai, UAE  
Tel.: +971 4881 2524  
Email: cs\_me@bradycorp.com

**Norway**

Kjeller  
Tel.: +47 70 13 40 00  
Email: norway@bradycorp.com

**Spain & Portugal**

Madrid, Spain  
Tel.: +34 900 902 993  
Email: spain@bradycorp.com,  
portugal@bradycorp.com

**Sweden, Finland, Baltic states**

Kista, Sweden  
Tel.: +46 (0) 8 590 057 30  
Email: sweden@bradyeurope.com

**Turkey**

Istanbul  
Tel.: +90 212 264 02 20 / 264 02 21  
Email: turkey@bradycorp.com

**UK & Ireland**

Banbury, UK  
Tel.: +44 (0) 1295 228 288  
Email: uk@bradycorp.com

**Our mission is to identify and protect people, products and premises**



To help minimise our impact on the environment, Brady limits its number of reprints.

Updated versions are always available for download on [www.bradyeurope.com](http://www.bradyeurope.com).



Search for: EUR-M-314-EN



Y5178106

Your distributor