

i-Autoc

Your Automation Partner



Innovation
Automation
Unique
Technology
Optimization
Commitment

Product Selection

Core value

Innovation
Automation
Unique
Technology
Optimization
Commitment

About us

Kudom Electronics is a national high-tech enterprise which is in compliance with the intellectual property management system. The company is a ISO9001:2015, ISO14001:2015 & OHSAS18001:2007 certified enterprise, and has a professional R&D team with more than 20 years of experience in product design and manufacturing process.

Kudom Electronics has a product testing center with complete facilities for wide range of performance and reliability tests. Kudom electronics provides more than 50 categories, with over 3000 kinds of specifications of various types of power semiconductor switching products. Kudom Electronics was the first company that launched the intelligent switching parts with self-detection, self-diagnosis, and networked functions products in the same industry. Our products are in compliance with IEC62314, IEC60947, IEC60335, IEC61000 and other international standards, and most of the products are certified by CE, TUV, UL, CCC, S-mark and other agency approvals. We also provide customized products.

Our advantages:

- ★ **Globalization:** i-Autoc distribution network covers more than 50 countries and territories, which enables us to provide strong technical support with quick responses.
- ★ **Professional:** i-Autoc owns more than 20 patents. We are not only specializing in the manufacturing of standard & intellectual solid state relays, but also keep researching and developing the high performance Triac & SCR, which are the key components of solid state relays.
- ★ **Reliability:** Most of i-Autoc products are approved by CCC, UL, TUV, S-mark and CE. We are the reliable cooperation partner with high quality products and services, and we are also available to provide customized products.
- ★ **Innovation:** Based on the fundamental technology of SSR's, we also offer the intellectual, high-efficient and customized products, such as motor reversing modules, voltage regulator modules, industrial modules, etc.



Product Selection

PCB Mount

AC Output

KSA	01
KSB	01
KSC	01
KSD	01
KSG	02
KSH	02
KSG3R	02

DC Output

KSF	02
KSL	03
KSCD	03
KSGD	03
KG3RD	03

Panel Mount

Single Phase | AC Output

KSIM	04
KSIM(045)	04
KSI	04
KSI(068)	04
KSI(083)	05
KSU	05
KSIA	05
KSID	05

Single Phase | DC Output

KSJ	06
-----	----

Three Phase | AC Output

KSQF	06
KSQC	06

DIN Rail Mount

KSV	07
KST	07
KSG***D	07
KSMA***D	07
KSG3R***D	08
KSGD***D	08
KSMD***D	08
KG3RD***D	08

Industrial Module

DRA-1/KSD	09
DRA-2/KSD	09
DRA-4/KSD	09
DRA-8/KSD	09
DRA-1/KSF	10
DRA-2/KSF	10
DRA-4/KSF	10
DRA-8/KSF	10

Motor Reversing

KMB	11
KMC	11
KMS	11
KSJD	12
KMTY	12
KMTYM	12

Voltage Regulator

KRB	13
KWR	13
KYR	13
KYRT	13

Intelligent Module

BCA	14
DRC	14
DRD	14
DRF	14

Accessories

Heat Sink	15-16
Thermal Pad	17
Din Rail Clip	17
Socket	17
Protection Cover	17

PCB Mount

KSG Series AC Output

Output: AC Current Range: 2A-3A

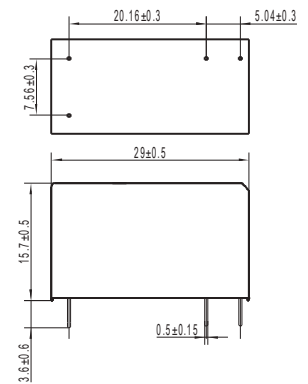
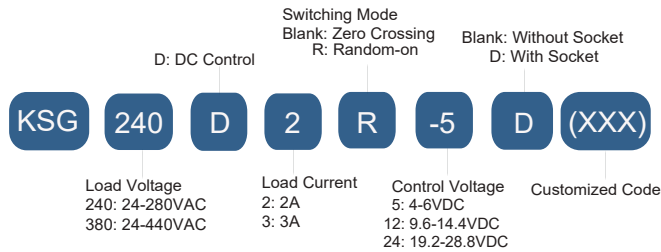

KSH Series AC Output

Output: AC Current Range: 25A

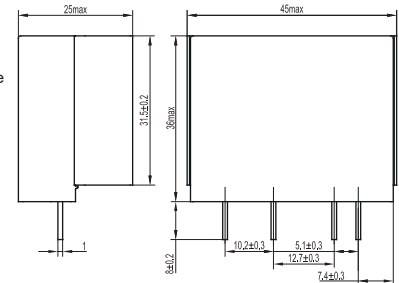
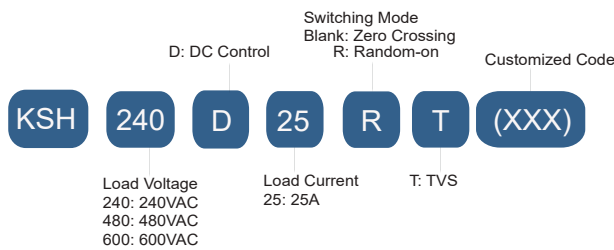

KSG3R Series AC Output

Output: AC Current Range: 2A-3A

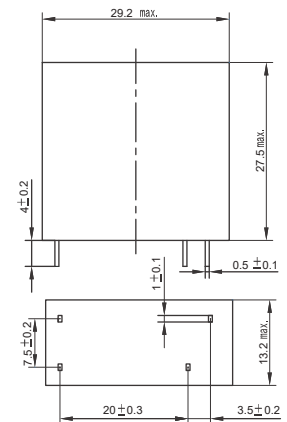
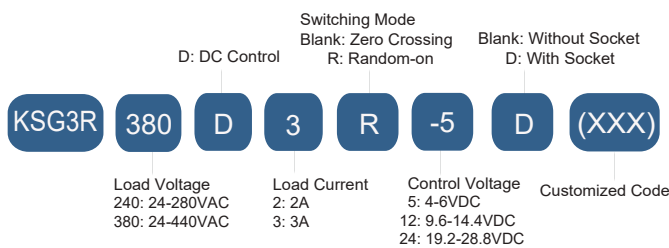

KSF Series DC Output

Output: DC Current Range: 5A

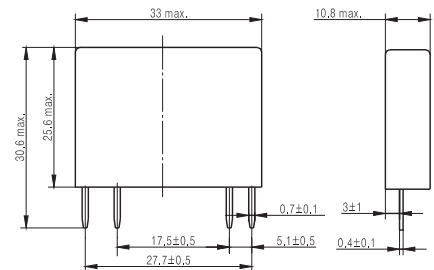
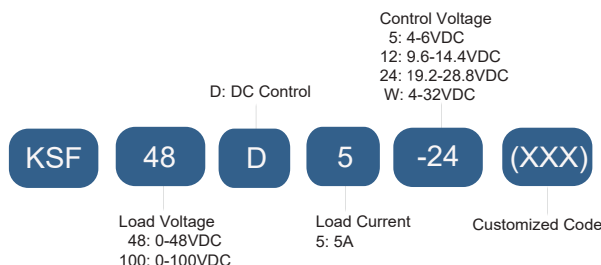

KSL Series DC Output

Output: DC Current Range: 3A - 20A

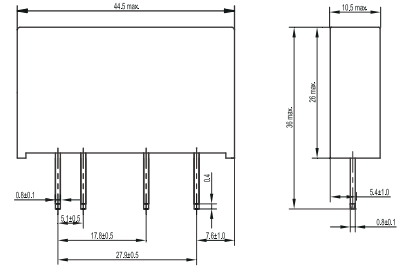
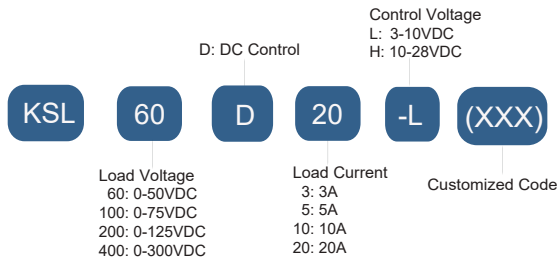

KSCD Series DC Output

Output: DC Current Range: 1A - 4A

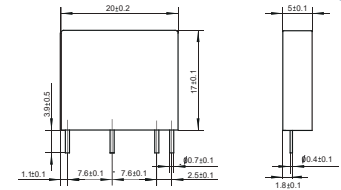
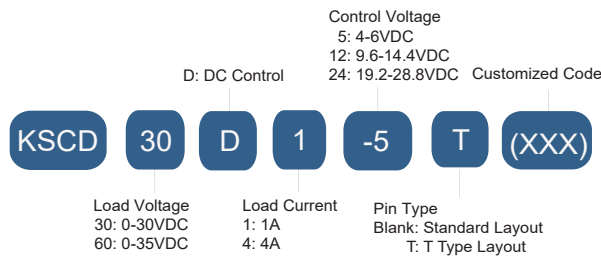

Standard Layout

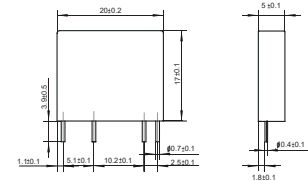

T Type Layout

KSGD Series DC Output

Output: DC Current Range: 2A - 5A

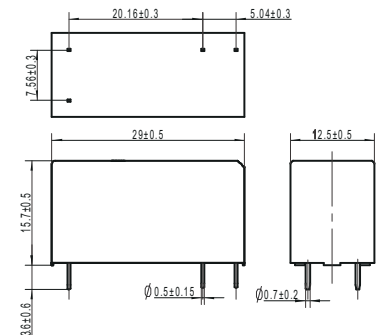
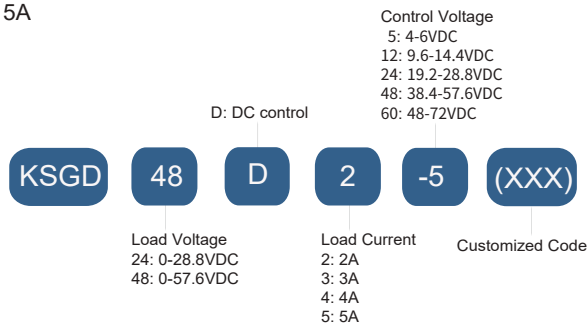

KG3RD Series DC Output

Output: DC Current Range: 2A

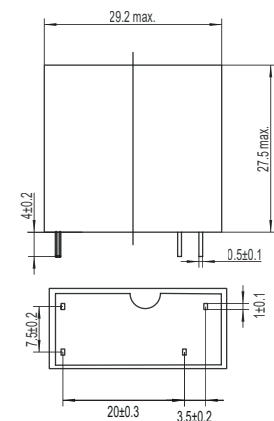
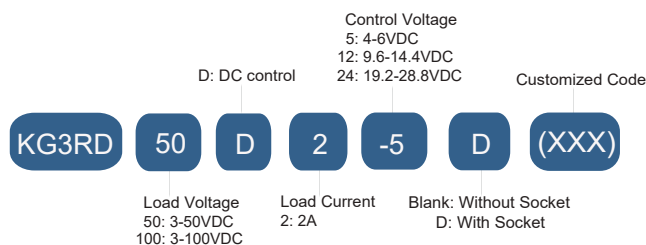

Panel Mount

KSIM Series Mini Single Phase AC Output

Output: AC Current Range: 10A-25A

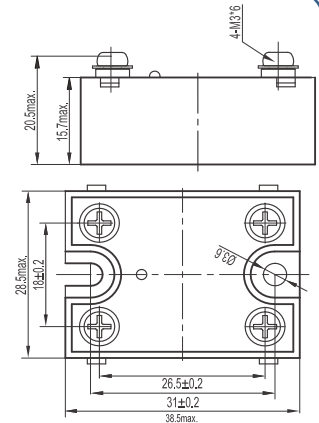
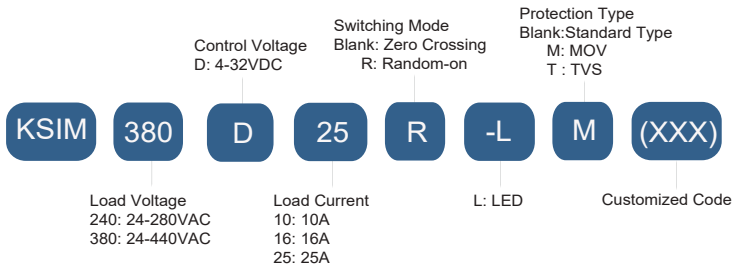

KSIM (045) Series Mini Single Phase AC Output

Output: AC Current Range: 10A-25A

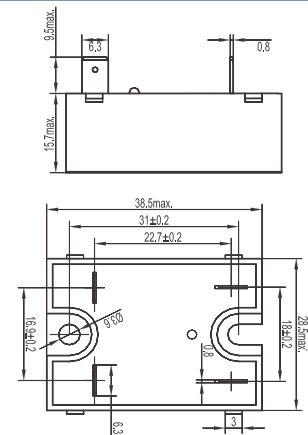
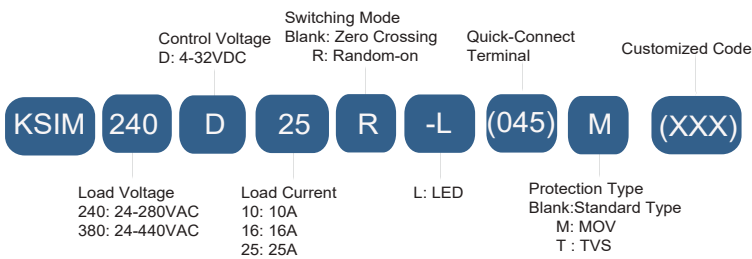

KSI Series Single Phase AC Output

Output: AC Current Range: 25A-60A

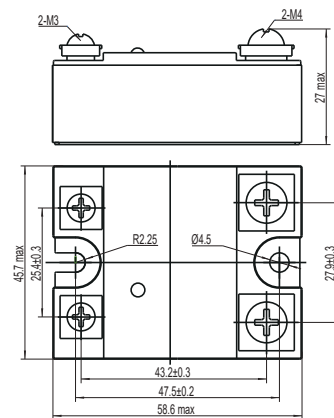
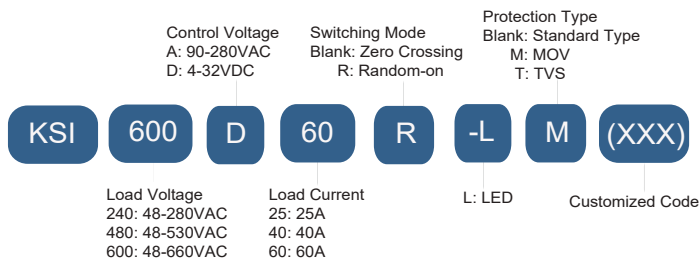

KSI(068) Series Single Phase AC Output

Output: AC Current Range: 25A-80A

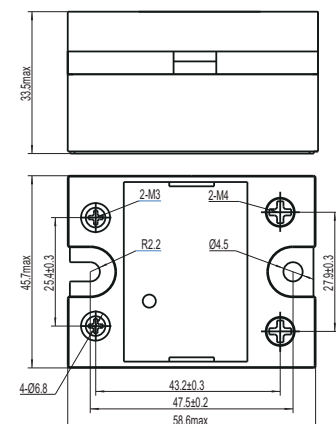
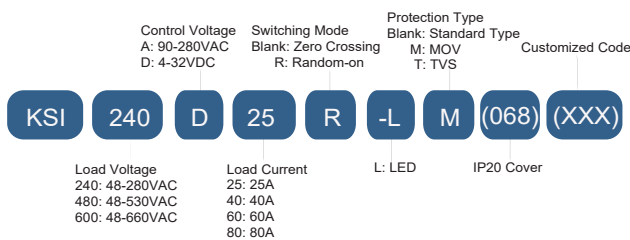

KSI(083) Series Single Phase AC Output

Output: AC Current Range: 80A-125A



Control Voltage
A: 90-280VAC
D: 4-32VDC

Switching Mode
Blank: Zero Crossing
R: Random-on

Protection Type
Blank: Standard Type
M: MOV
T: TVS

KSI 240 D 125 R -L M (083)

Load Voltage
240: 48-280VAC
480: 48-530VAC
600: 48-660VAC

Load Current
80: 80A
100: 100A
125: 125A

L: LED 083: Higher Profile

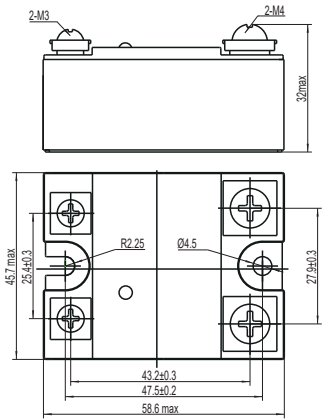

KSU Series Single Phase AC Output

Output: AC Current Range: 30A-75A



Control Voltage
A: 90-280VAC
D: 4-32VDC

Switching Mode
Blank: Zero Crossing
R: Random-on

Protection Type
Blank: Standard Type
M: MOV
T: TVS

KSU 240 D 30 R -L M (XXX)

Load Voltage
240: 24-280VAC
600: 24-660VAC

Load Current
30: 30Amp
50: 50Amp
75: 75Amp

L: LED Customized Code

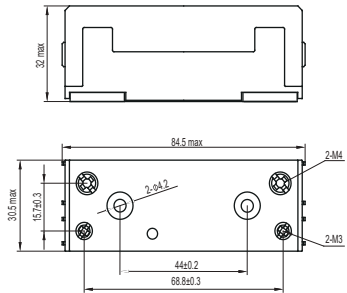

KSIA Series Single Phase AC Output

Output: AC Current Range: 25A-100A

Built in Function: SCR Short Circuit, Open Circuit and Error Self-Inspection



Control Voltage
D: DC

Blank: Negative Trigger
P: Positive Trigger

KSIA 600 D 25 -P -L (XXX)

Load Voltage
240: 150-280VAC
480: 150-530VAC
600: 300-660VAC

Load Current
25: 25A
40: 40A
60: 60A
80: 80A
100: 100A

L: LED Customized Code

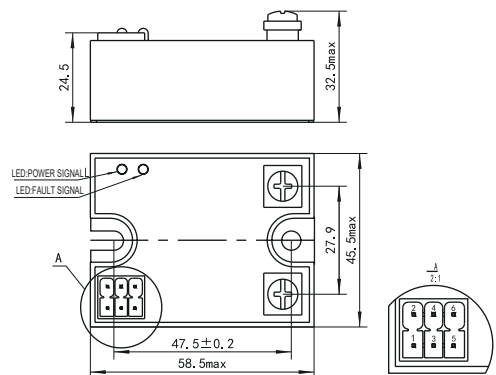

KSID Series Dual Pole AC Output

Output: AC Current Range: 25A-50A



Control Voltage
LD: 4-15VDC
HD: 15-32VDC
D: 4-32VDC

Switching Mode
Blank: Zero Crossing
R: Random-on

Customized Code

KSID 240 LD 25 R P (XXX)

Load Voltage
240: 24-280VAC
480: 24-530VAC
600: 24-660VAC

Load Current
25: 25A
40: 40A
50: 50A
75: 75A

Blank: 4 Pin Connector
P: Screw Terminal

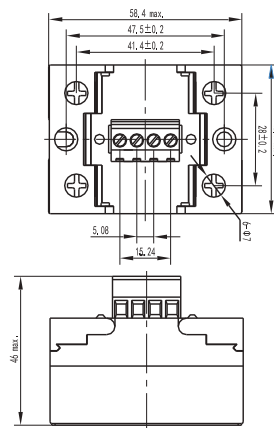

Panel Mount

KSJ Series Single Phase DC Output

Output: DC Current Range: 7A-100A



KSJ 100 D 80 -L (XXX)

Control Voltage
D: 4-32VDC

Load Voltage
30: 0-24VDC
50: 0-36VDC
60: 0-48VDC
100: 0-75VDC
200: 0-120VDC
400: 0-300VDC
600: 0-500VDC
1200: 0-650VDC

Load Current
7: 7A 40: 40A
10: 10A 50: 50A
20: 20A 80: 80A
25: 25A 100: 100A
30: 30A

L: LED Customized Code

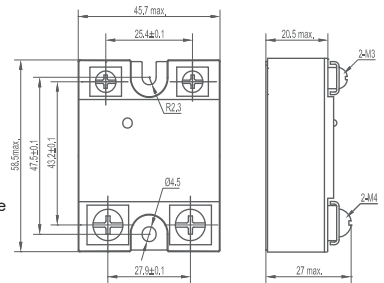

KSQF Series Three Phase AC Output

Output: AC Current Range: 25A-80A



KSQF 480 D 80 R (XXX)

Control Voltage
A: 90-280VAC
D: 4-32VDC

Load Voltage
480: 24-530VAC
600: 24-660VAC

Switching Mode
Blank: Zero Crossing
R: Random-on

Load Current
25: 25A
40: 40A
60: 60A
80: 80A

Customized Code

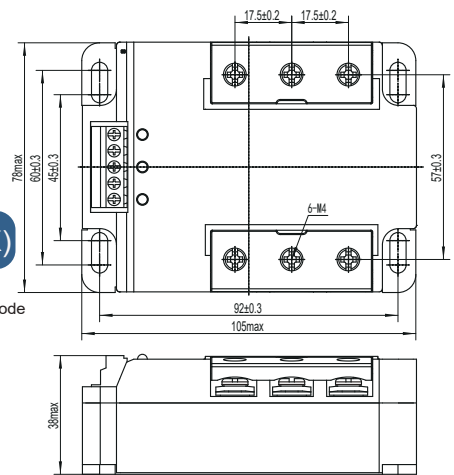

KSQC Series Three Phase AC Output

Output: AC Current Range: 25A-80A

Built in Function: Phase-loss Protection / Over Temperature Protection / SCR Fault Detection / Alarm Signal Output(optional)



KSQC 600 D 60 R -C (XXX)

Control Voltage
D: 10-32VDC

Load Voltage
480: 180-530VAC
600: 180-660VAC

Load Current
25: 25A
40: 40A
60: 60A
80: 80A

Switching Mode
Blank: Zero Crossing
R: Random-on

Blank: Without Alarm Signal Output
C: With Alarm Signal Output

Customized Code

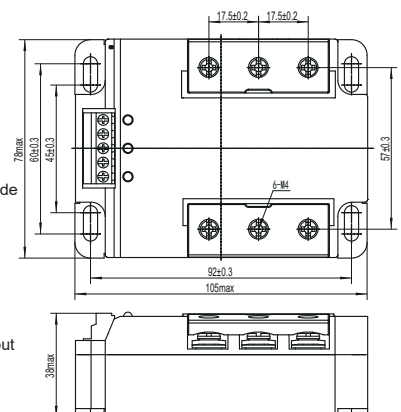

KSV Series Single Phase AC Output

Output: AC Current Range: 10A - 75A

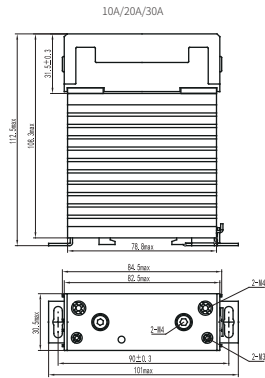
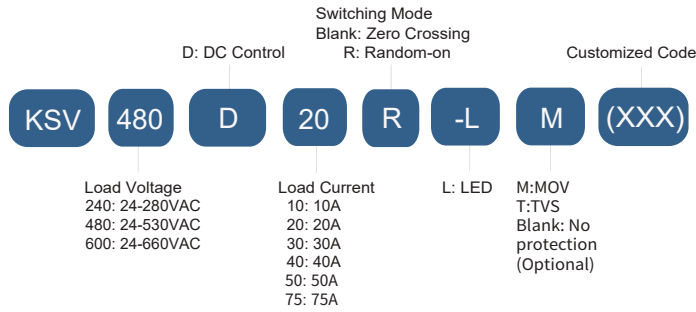

KST Series Dual pole AC Output

Output: AC Current Range: 20A-30A

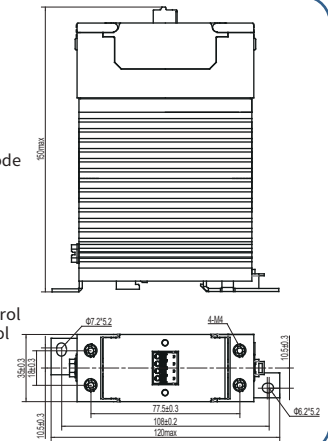
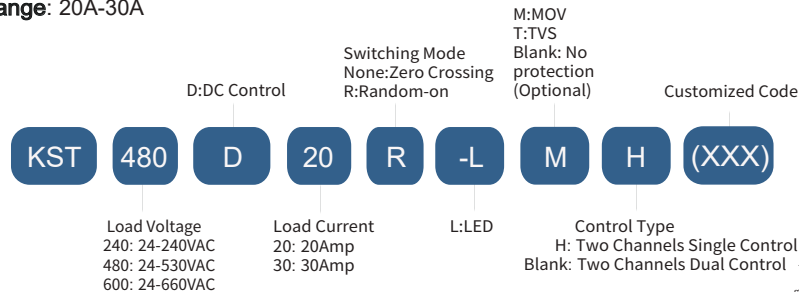

KSG***D Series AC Output

Output: AC Current Range: 2A - 3A

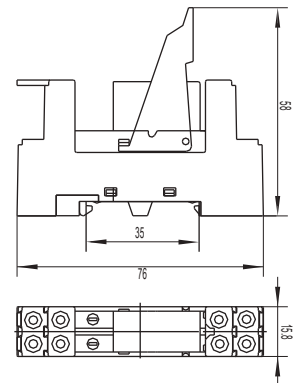
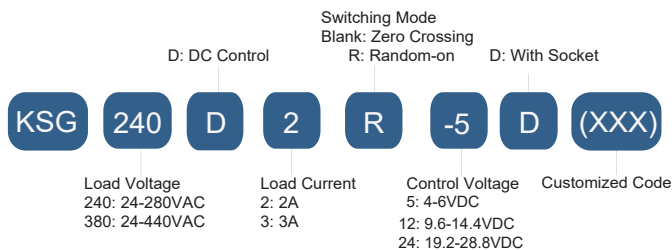

KSMA***D Series Single Phase AC Output

Output: AC Current Range: 1A - 2A

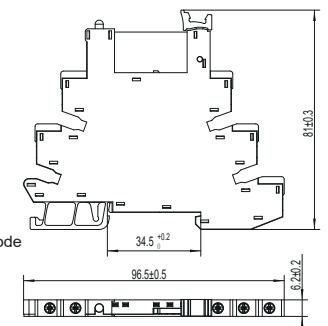
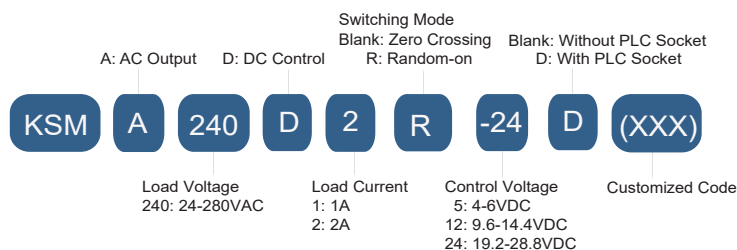

Din-Rail Mount

KSG3R***D Series AC Output

Output: AC Current Range: 2A - 3A



Switching Mode
Blank: Zero Crossing
R: Random-on

D: DC Control
D: With Socket

KSG3R 380 D 2 R -5 D (XXX)

Load Voltage
240: 24-280VAC
380: 24-440VAC

Load Current
2: 2A
3: 3A

Control Voltage
5: 4-6VDC
12: 9.6-14.4VDC
24: 19.2-28.8VDC

Customized Code

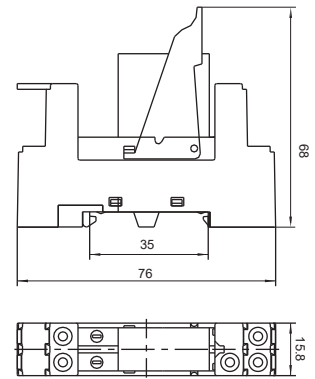

KSGD***D Series DC Output

Output: DC Current Range: 2A - 5A



Control Voltage
5: 4-6VDC
12: 9.6-14.4VDC
24: 19.2-28.8VDC
48: 38.4-57.6VDC
60: 48-72VDC

D: DC control

Customized Code

KSGD 48 D 2 -5 D (XXX)

Load Voltage
24: 0-28.8VDC
48: 0-57.6VDC

Load Current
2: 2A
3: 3A
4: 4A
5: 5A

D: With Socket

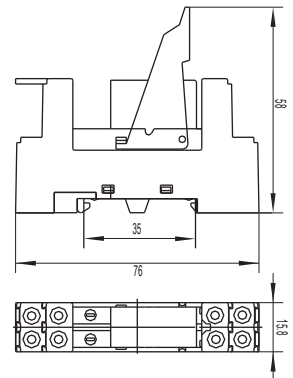

KSM D***D Series Single Phase DC Output

Output: DC Current Range: 0.1A - 4A

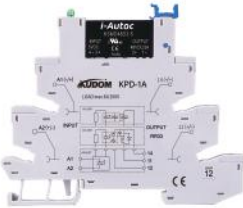

Control Voltage
5: 4-6VDC
12: 9.6-14.4VDC
24: 19.2-28.8VDC
48: 38.4-57.6VDC
60: 48-72VDC

D: DC Output

D: DC Control

Customized Code

KSM D 48 D 3 -24 D (XXX)

Load Voltage
24: 3-28VDC
48: 48-58VDC

Load Current
0.1: 0.1A
2: 2A
3: 3A
4: 4A

Blank: Without Socket
D: With Socket

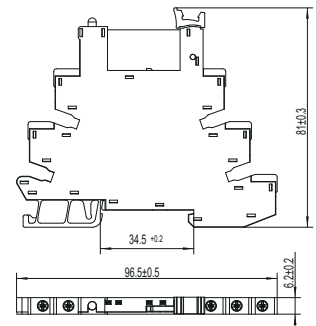

KG3RD***D Series DC Output

Output: DC Current Range: 2A



Control Voltage
5: 4-6VDC
12: 9.6-14.4VDC
24: 19.2-28.8VDC

D: DC Control

Customized Code

KG3RD 50 D 2 -5 D (XXX)

Load Voltage
50: 3-50VDC
100: 3-100VDC

Load Current
2: 2A

Blank: Without Socket
D: With Socket

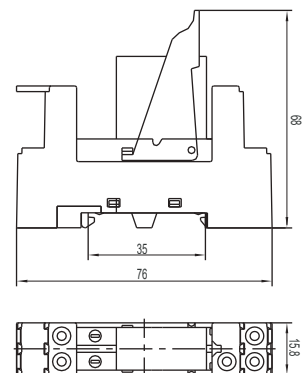

KMB Series Three Phase Motor Reversing Module

Output: AC Current Range: 10A-20A

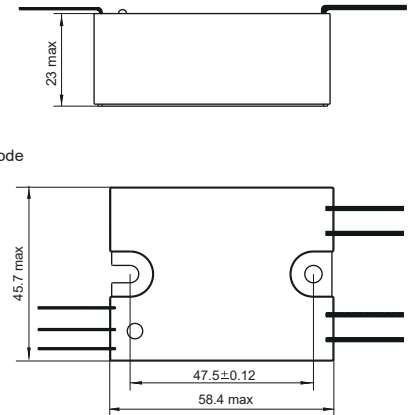
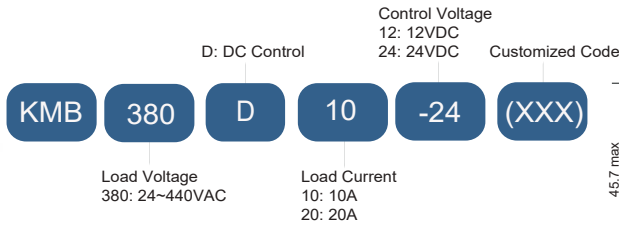

KMC Series Single Phase Motor Reversing Module

Output: AC Current Range: 10A-40A

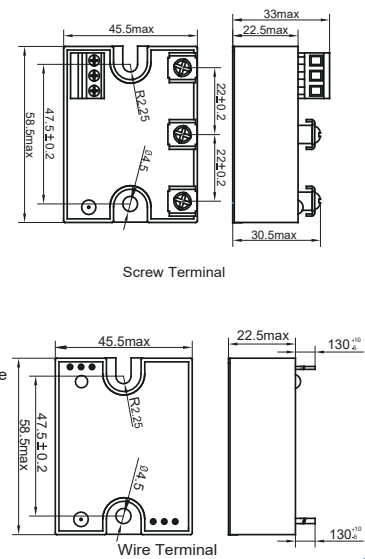
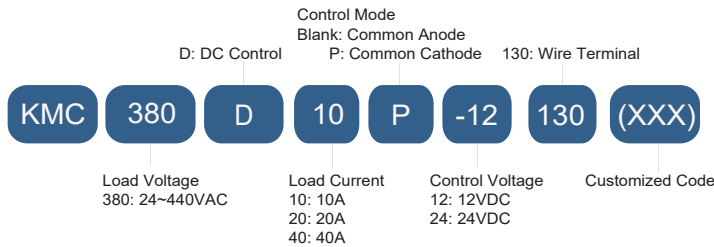

KMS Series Three Phase Motor Reversing Module

Output: AC Current Range: 25A-60A

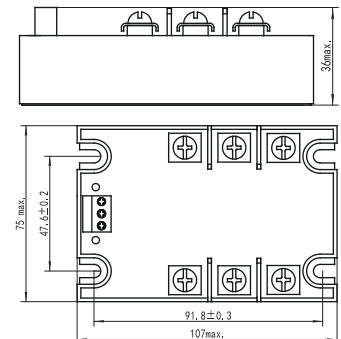
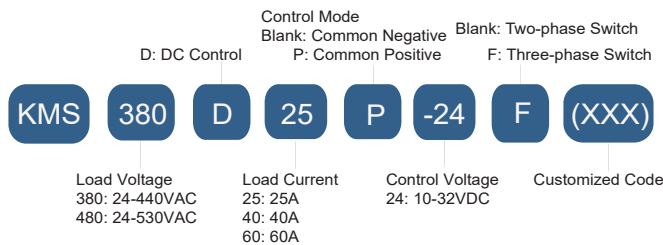

KSJD Single Phase DC to DC Motor Reversing Module

Output: DC Current Range: 10A

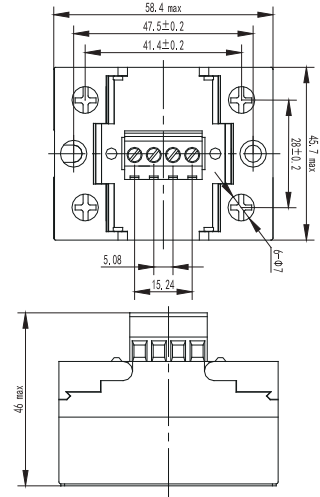
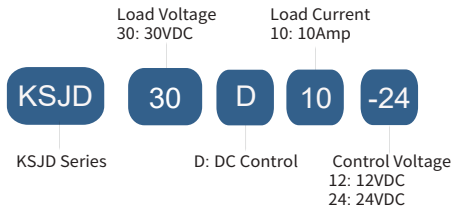

KMTY Series Three Phase Motor Reversing Module

Output: AC Current Range: 25A-80A

Built in Function: Automatic Phase Correction / Phase-loss Protection(optional)

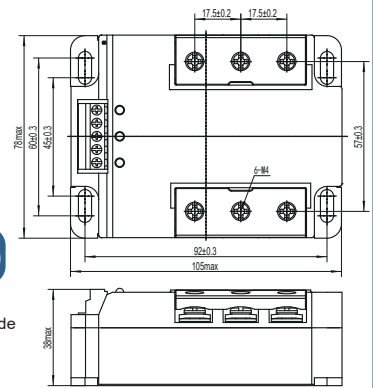
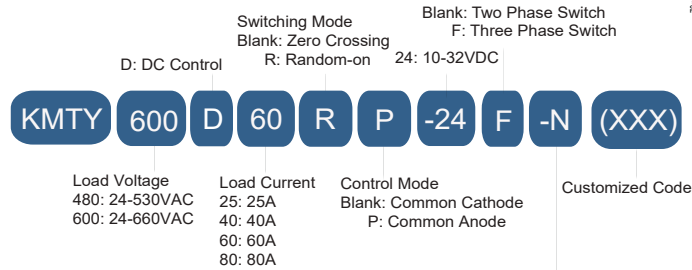

Blank: With Automatic Phase Correction & Phase-loss Correction Function
N: Without Automatic Phase Correction & Phase-loss Correction Function

KMTYM Series Mini Three Phase Motor Reversing Module

Output: AC Current Range: 15A-25A

Built in Function: Automatic Phase Correction / Phase-loss Protection(optional)

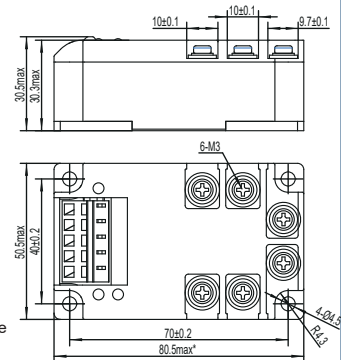
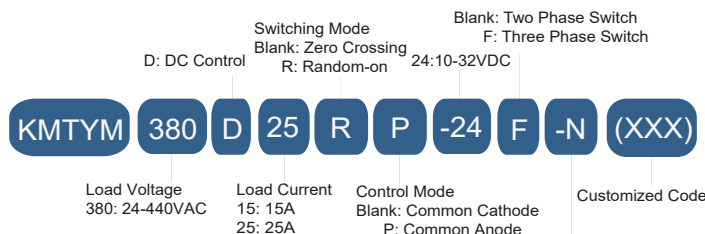
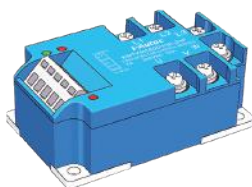

Blank: With Automatic Phase Correction & Phase-loss Correction Function
N: Without Automatic Phase Correction & Phase-loss Correction Function

BCA Series Temperature Control Module



Load Voltage
240: 240VAC
380: 380VAC

Load Current
40: 40Amp

BCA **240** **T** **40** **-S4**

Temperature Sensor
T: Thermal Coupler

Control Mode
S4: RS 485

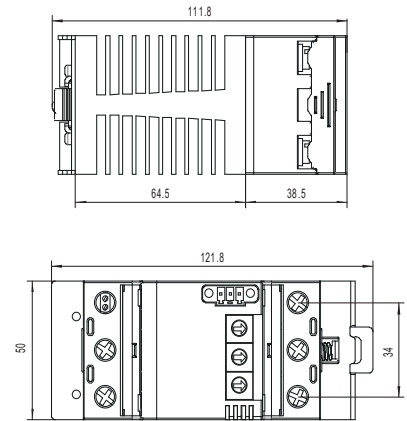

DRC Series Mod-Bus Current Detection Module



Channel
8: 8 Channels

Rated Current
20: 20Amp

Control Mode:
RS 485

DRC **8** **A** **20** **A** **S4**

Current type
A: AC

Tolerance
A: ±5%

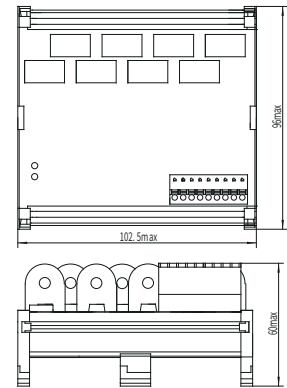

DRD Intelligent Module Voltage Regulator



Channel
4: 4 Channels

Load Voltage
220: 220VAC

Load Current
5: 5A

DRD **4** **D** **220** **P** **5** **S4**

D: DC Control

Output Mode
P: Power Proportional Output

Control Mode
S4: RS 485

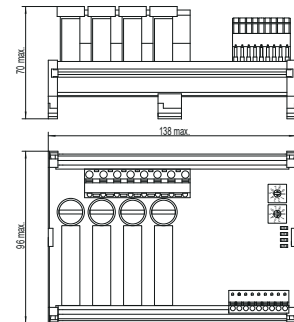

DRF Series Multi-channels Modbus Voltage Regulator



Channel
12: 12 Channels

Load Voltage
220: 220VAC

Control Mode
S4: RS 485

DRF **12** **S** **220** **P** **-S4**

Function
S: Steady Output Voltage

Output Mode
P: Power Proportional Output

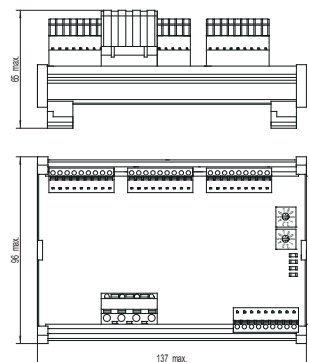

Heatsink



KHS-A50 Heatsink
Weight: 115g
Thermal Resistance: 2.1°C/W
Suitable for KSI, KSID, KSJ, KWR, KSQM, KMB
KMC, KSIA, KYR

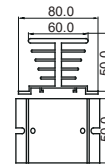
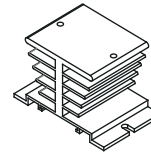

KHS-A32 Heatsink
Weight: 70g
Thermal Resistance: 2.8°C/W
Suitable for KSIM

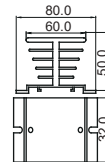
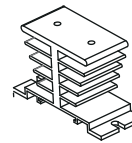

KHS-B70 Heatsink
Weight: 235g
Thermal Resistance: 1.9°C/W
Suitable for KSI, KSID, KSJ, KWR, KSQM, KMB
KMC, KSIA, KYR

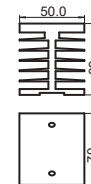
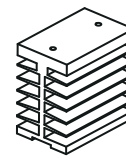

KHS-B70-D Heatsink with DIN Rail
Weight: 290g
Thermal Resistance: 1.9°C/W
Suitable for KSI, KSID, KSJ, KWR, KSQM, KMB
KMC, KSIA, KYR

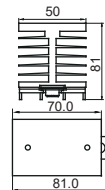
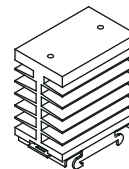

KHS-C49 Heatsink
Weight: 255g
Thermal Resistance: 1.7°C/W
Suitable for KSI, KSID, KSJ, KWR, KSQM, KMB
KMC, KSIA, KYR

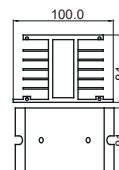
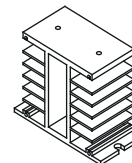

KHS-D50 Heatsink
Weight: 375g
Thermal Resistance: 1.6°C/W
Suitable for KSI, KSID, KSJ, KWR, KSQM, KMB
KMC, KSIA, KYR

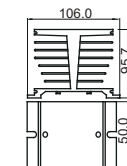
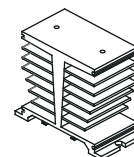

KHS-D50-F Heatsink with Fan
Weight: 645g
Thermal Resistance: 0.6°C/W
Suitable for KSI, KSID, KSJ, KWR, KSQM, KMB
KMC, KSIA, KYR

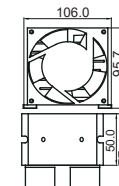
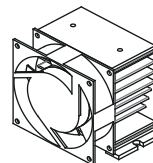

KHS-E76 Heatsink
Weight: 300g
Thermal Resistance: 1.4°C/W
Suitable for KSI, KSID, KSJ, KWR, KSQM, KMB
KMC, KSIA, KYR

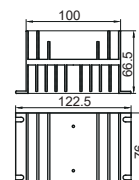
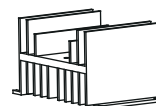



KHS-F150 Heatsink

Weight: 539g
Thermal Resistance: 0.6°C/W
Suitable for KSI, KSID, KSJ, KWR, KYR, KSIA, KSQC, KMS, KMT, KMTY, KMB, KMC, KSQF, KYRT

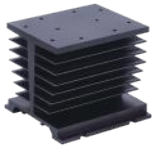
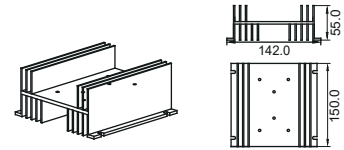

KHS-D110 Heatsink

Weight: 825g
Thermal Resistance: 0.8°C/W
Suitable for KSI, KSID, KSJ, KWR, KYR, KSIA, KSQC, KMS, KMT, KMTY, KMB, KMC, KSQF, KYRT, KMTYM, KRB

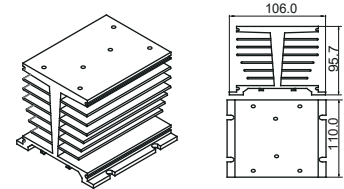

KHS-D110-F Heatsink with Fan

Weight: 1095g
Thermal Resistance: 0.35°C/W
Suitable for KSI, KSID, KSJ, KWR, KYR, KSIA, KSQC, KMS, KMT, KMTY, KMB, KMC, KSQF, KYRT, KMTYM, KRB

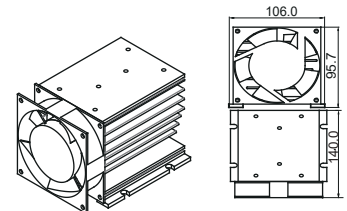

KHS-G150 Heatsink

Weight: 2320g
Thermal Resistance: 0.4°C/W
Suitable for KSI, KSID, KSJ, KWR, KYR, KSIA, KSQC, KMS, KMT, KMTY, KMB, KMC, KSQF, KYRT

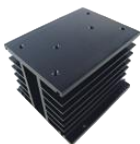
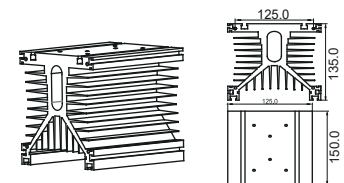

KHS-C110 Heatsink

Weight: 560g
Thermal Resistance: 0.9°C/W
Suitable for KSI, KSID, KSJ, KWR, KYR, KSIA, KSQC, KMS, KMT, KMTY, KMB, KMC, KSQF, KYRT, KMTYM, KRB

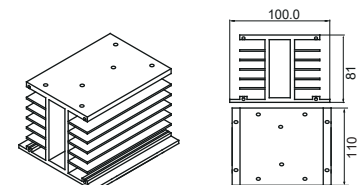

KHS-C110-F Heatsink with Fan

Weight: 830g
Thermal Resistance: 0.4°C/W
Suitable for KSQF, KSQC, KMS, KMT, KMTY

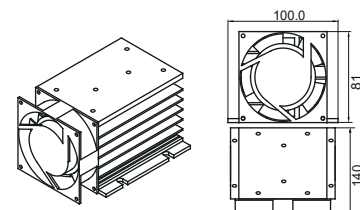

KHS-B90 Heatsink

Weight: 390g
Thermal Resistance: 1.7°C/W
Suitable for KRB

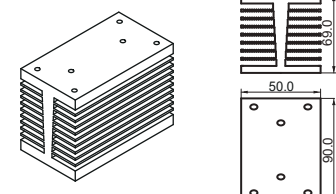

Thermal Pad KTP-0(A)



Thermal Pad KTP-1



Thermal Pad KTP-2



Din-Rail DR-1



Din-Rail DR-3



DIN Rail Socket KPD-1A
for KSMA/KSMD

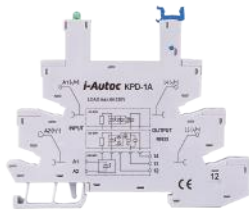

DIN Rail Socket KPD-3A
for KSG/KSGD



DIN Rail Socket KPD-4A
for KSG3R/KG3RD



1 Phase Protection
Cover KPC-0A



3 Phase Protection
Cover KPC-1A



Mini 1 Phase Protection
Cover KPC-2A



1. Typical operation sequence of an AC SSR

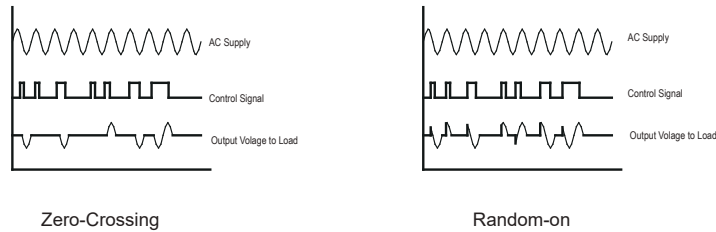

2. Typical operation sequence of an AC voltage regulator

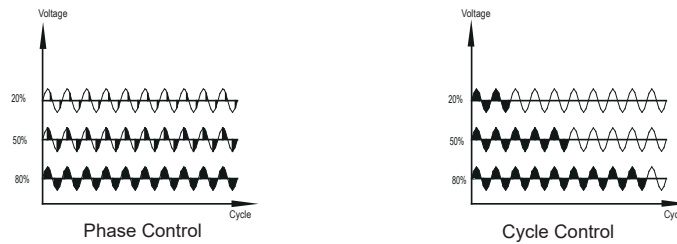

3. What types of loads are used for Zero Cross and Random turn-on SSR?

For AC output SSR, there are two switching ways zero-crossing and random-on. Except for some special application (for example, phase angle control must apply random-on), zero-crossing SSR is recommended for, resistive, capacitive, lamp and slightly inductive loads. Random-on relays are used for highly inductive loads, or when you need to phase angle fire a load. If a SSR is applied to a special application, please contact KUDOM for technical support.

4. How to calculate the rating current of a resistive load?

Single-phase: $I = P/220$ or $I = P/380$

Three-phase: $I = P\sqrt{3}/380$

Considering the ambient temperature, heat emission and other conditions, it is prudent to include 40-80% safety margin for load current, when selecting a SSR for resistive load.

5. How to calculate the steady-state current of a motor load?

Single-phase motor: $I = P/220/0.85$

Three-phase motor: $I = P/\sqrt{3}/380/0.85$

When the motor turns on, the surge current could be 5-7 times of steady-state current for several seconds.

6. How to choose an appropriate MOV for an application using a SSR?

SSR is used for various applications, overvoltage may occur during its operation. We can use MOV to suppress the transient voltage on power components, reducing the damage to SSR. To choose an appropriate MOV, first you must determine circuit conditions such as peak voltage and current during the event. You also must determine the number of surges the MOV must survive as well as the acceptable let-through voltage for the application. The transient overvoltage endurance of a 380 series AC SSR is 800V, it can operate a 220VAC load, or lower, without MOV. The transient overvoltage endurance of a 480 series AC SSR is 1200V, it can operate a 380VAC load, or lower, without MOV.

7. Over-current and short-circuit protection

There is no over-current protection designed in KUDOM regular SSR. We suggest that, a thermal relay can be series to the load for over-current protection, and a semi-conductor style fuse be placed in series with the load circuit to help protect the SSR from short circuit

8. How to protect a DC SSR controlling an inductive load?

To protect a DC SSR from the electromagnetic field (EMF) when the inductive load is turned off, you need to place a diode in reverse parallel across the load.

9. Why do I see leakage current from the SSR when the relay is not on?

During the SSR is turned-off, we can observe an extremely small current when apply a voltage to SSR output, due to the power component has an impedance. Besides, the leakage current is caused by the snubber network which is a resistor and capacitor in series placed in parallel across the output of the SSR. This snubber protects the relay from static and commutating dv/dt .

10. Why do I need to use a heat sink with a SSR?

When a SSR is on, the relay will generate heat due to the forward voltage drop across the output. The amount of power generated is a function of the load current. The maximum chip temperature for a SCR is 125°C, if the SCR exceeds this temperature it can go into thermal run away. This will cause you to lose the ability to turn the relay off. The heat sink takes the heat generated by the SSR and dissipate it keeping the SSR cooler.

11. Selection of heat sink

To select the proper sized heat sink, you need to know 2 things: the load current and the maximum ambient temperature the relay will be exposed to. Once you know these parameters and have selected the proper SSR, you can now use the thermal derating curves included in the data sheet of the particular model you have selected. For example: SSR # KSI240D60-L, if you want to use it load current at 36A, ambient temperature at 60°C, with this example we go to the data sheet and find 60 A thermal curve. On the left side we find 36A and draw a line straight across to the right then we find the ambient temperature of 60°C on the bottom and draw a line straight up until it intersects with the previous line. At this point we can see that the point falls between the 1.4°C/W and the 0.6°C/W line. You always pick the rating above your point since the heat sink rating below would not keep the relay cool enough. So therefore we need a 0.6°C/W sized heat sink.

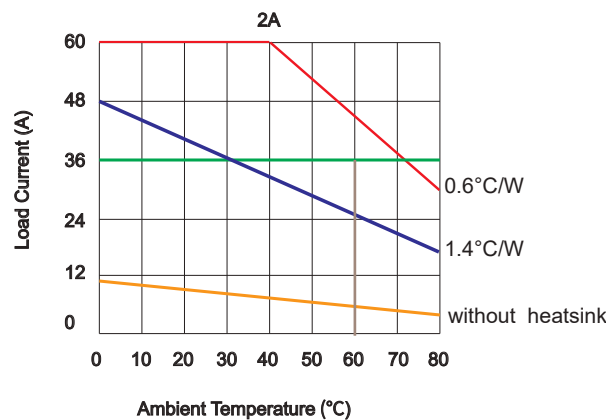



Xiamen Kudom Electronics Technology Co.,Ltd
Add:No.52,Hongtangtou 1st Road,Xike Town,Tongan District,Xiamen
Tel.:+86-592-7156029
Fax:+86-592-7156038
sales@i-autoc.com
www.i-autoc.com

Technical support
+86 180 5926 3013 (SSR, Voltage Regulator, Motor Reversing)
+86 180 5926 9771 (Intelligent Module)
US technical support line: +1 440-479-9905

REGIONAL DISTRIBUTOR

