



## Laboratory Identification

Labels, printers & software for laboratories

# About BRADY



**Once you have worked with BRADY, our name will stick with you, (just like our labels) because BRADY is one of the world's leading labelling and identification specialists.**

## Innovative

At BRADY we continue to improve. We have many customers from all industries, and we strive to be ahead of their needs by continuing to invest in research for even more performant solutions. By developing more user-friendly and efficient concepts, we give our thousands of customers the best in the market.

## Strength

At BRADY, we believe our biggest strength is the wide range of identification and safety solutions we can offer our customers, whether it's labelling the smallest component or complete signage for an entire warehouse. We're also proud to offer many products and services - from printers, scanners and software to service contracts and on-site training - that compliment any identification job. And don't forget, our wide network of expert distributors can always offer you a tailor-made solution to meet your specific requirements.

## Trust

For over a hundred years, BRADY has been connected with quality, trust and stability. We demand the best for your products and services, because we know, better than anyone, the importance of good and reliable identification. Identification looks like a small detail, but every professional knows that this kind of detail is crucial to any business.

## Inform

We also have specialised dealers in your region, who can answer all your identification, safety and labelling questions, specific to your activity. They will be happy to provide you with all kinds of options and solutions with no obligation.

Microsoft is a trademark of Microsoft Corporation, Bluetooth is a trademark of Bluetooth Sig, Inc., Android is a trademark of Google Inc.



Brady products are sold on the condition that the purchaser will test them in actual use and determine for himself/herself their suitability to his/her intended purpose. Brady warrants to the purchaser that Brady products are free from defects in material and workmanship but limits its obligation under this warranty to the replacement of the product which has been shown to Brady's satisfaction to have been defective at the time of its purchase.

The warranty does not extend to any persons who have acquired the product from the purchaser. It is in lieu of any other warranty, including every warranty of sale-ability, marketability or suitability for the intended purpose, and is also in lieu of any other obligation or liability on the part of Brady.

Under no circumstances will Brady be liable for losses, damage, costs or subsequent damage of whatever nature which may arise in connection with the use of, or inability to use, Brady's products.

# Laboratory Identification

## Labels, printers & software for the laboratory

### TABLE OF CONTENT

Simplify Your Laboratory Identification ..... 4

#### Laboratory Identification Labels

Choose your Application .....	6
Vial / Tube Labels .....	8
Vial Top Labels .....	13
Centrifuge / Microcentrifuge Labels .....	15
Cryo Tubes & Vials .....	19
Conical / Large Tube Labels .....	21
Slide Labels .....	27
Tissue Cassette Labels .....	28
Straw and Rod Labels .....	29
Well Plate Labels .....	30
Bottles / Flasks & Dishes .....	34
Bottle Tamper Seal Labels .....	37
General Lab ID .....	37

#### Label Printers, Label Attachment System and Barcode Scanners

Choose Your Printer .....	42
BMP21-LAB Label Printer .....	44
BMP51 Label Printer .....	45
BMP61 Label Printer .....	46
BMP71 Label Printer .....	48
BBP12 Label Printer .....	49
BBP33 Label Printer .....	50
BradyPrinter i5100 .....	51
BradyPrinter i7100 .....	52
BSP31 Label Attachment System .....	54
Label Creation Software .....	55
Scanners for Laboratories .....	56

#### Miscellaneous Products

Hazardous Substance Identification .....	60
Sorbent Products .....	62
Pipemarkers .....	66
Safety Signs on Rolls .....	66

### The Brady Advantage

When it comes to identification, safety and compliance, there's a clear advantage to working with Brady. We put our customers first in everything we do.

Our goal is to give you an unrivalled customer experience. We are relentlessly committed to performance and excellence - in our products, services and people.

Our products and solutions perform in ways that others simply can't match. Our people perform in ways that regularly exceed your expectations, and our focus and discipline work toward solid, long-term performance for our customers.

In short, Brady is the company you trust when performance matters most.

Learn more about the Brady Advantage at: [www.bradyeurope.com](http://www.bradyeurope.com)



# Simplify Your Laboratory Identification

Brady's laboratory identification products are designed to serve the world's biotechnology, agricultural, environmental and forensic researchers. Whether you work in pathology, histology, chromatography or other areas of science, Brady labelling solutions can help you maintain Good Laboratory Practice.

## Brady Sample Identification solutions:

- match existing vial, slide, and well plate sizes
- remain legible throughout processing and storage
- endure freezer storage, liquid nitrogen, autoclave, hot water baths and solvents including Xylene, DMSO and Ethanol
- allow bar coding for extensive information storage on even the tiniest sample
- integrate seamlessly with your Laboratory Information Management System (LIMS)

## Hand-written versus printed labels

Did you ever have to postpone research because of unidentified samples, or because nobody was able to read anymore what was once written on the sample you need? Printed laboratory labels, engineered specifically to identify samples, help avoid sample loss and a lot of frustration.



### Hand-Written Information

- Is difficult to read
- Smears when handled
- Has limited communication potential
- Fades over time when stored
- Is erased by chemicals

### Brady Printed Laboratory Labels

- Are crisp, clear and readable
- Do not smear nor fade
- Can hold much information
- Have increased durability
- Resist chemicals

## Lab-durable labels

Brady's special self-laminating or wrap around label protects your label's legend from extreme temperature, chemicals and solvents.

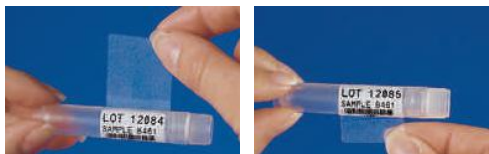

*For best adhesion, we recommend that you do not touch the adhesive side of the label when wrapping it around your vial or tube.*

- Printing is readable every time
- Clear portion wraps around and laminates the legend
- Provides window to view liquid level inside vial
- Low profile (extremely thin) label resists jamming in centrifuge or racks
- Labels withstand liquid nitrogen (-196°C), freezer (-80°C), autoclave (+121°C) and chemicals like Xylene



## On-site Label Creation

Brady printers enable professionals to print highly specialised identification labels on-site and on demand. Partnered with customisable software and a specific application system for laboratories, adaptable to specific processes or data file formats, Brady printers support considerable time savings and flexibility in sample identification.

Every Brady identification label can be printed on-site using a Brady mobile or benchtop printer. See page 42 for the full range of label printers.



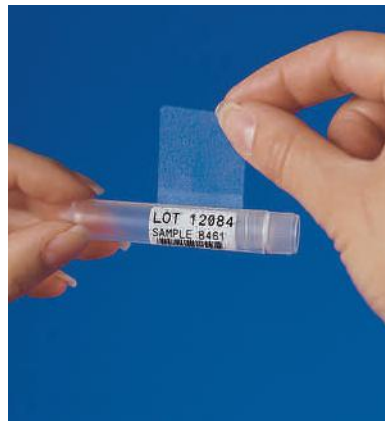

# Laboratory Identification Labels

Extensive material knowledge combined with chemical expertise enables Brady to develop durable labels that perform throughout sample storage and processing.

Choose your Application.....	6
Vial / Tube Labels.....	8
Vial Top Labels.....	13
Centrifuge / Microcentrifuge Labels .....	15
Cryo Tubes & Vials .....	19
Conical / Large Tube Labels .....	21
Slide Labels .....	27
Tissue Cassette Labels .....	28
Straw and Rod Labels.....	29
Well Plate Labels .....	30
Bottles / Flasks & Dishes .....	34
Bottle Tamper Seal Labels.....	37
General Lab ID .....	37

# Choose your Application



Vial/Tube



Conicals/bottles



Slide



Tissue cassette



Straw

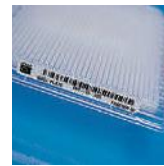

Well Plate



General Lab ID

Material	Printer Ribbon Series	Temp (°C) (Tested for 30 days)		APPLICATION						ENVIRONMENT				OTHER QUALITIES	
				Vial/Tube	Conical / Large Tubes	Slide	Tissue Cassette	Straw	Well Plate	General Lab ID	Freezer	Liquid Nitrogen	Autoclave (121°C)	Hot Water Bath (100°C)	Low-Profile (extremely thin)
<b>Freezerbondz™ Polyester</b>															
B-490	R4306	-196 °C	130 °C	✓	✓					✓	✓	✓	✓	✓	Retaining perfect integrity and legibility in liquid nitrogen, this ultra thin label avoids jamming in narrow racks and can be applied to already frozen surfaces with a small overlap.
B-492	R6400	-196 °C	110 °C	✓	✓					✓	✓	✓	✓	✓	Retaining perfect integrity and legibility in liquid nitrogen, this ultra resistant label, combined with the R6400 print ribbon, can resist a range of chemicals and can be applied to already frozen surfaces with a small overlap.
<b>Nylon Cloth</b>															
B-499	R4300; R6000; R6200B; R7950	-40 °C	90 °C	✓	✓					✓	✓	✓	✓	✓	Permanent adhesion; write-on capabilities. Temperature range increases to 121°C when used in autoclave process. Tested 3 cycles of 1 hour in 121°C at 15 psi for autoclave process. Available in white or yellow.
<b>Paper</b>															
B-424	R4300; R7950	-40 °C	50 °C							✓	✓				Permanent adhesive; write-on capabilities; good contrast and smear resistance.
<b>Polyester</b>															
B-423	R6000; R4410	-70 °C	110 °C	✓						✓	✓	✓	✓	✓	Permanent acrylic adhesive; ideal for flat surfaces. Suitable to adhering to glass, but not polypropylene.
B-430	R6000	-70 °C	100 °C	✓						✓	✓	✓	✓	✓	Clear polyester with permanent acrylic based adhesive; withstands numerous solvents and can be applied to variable surfaces.
B-432	R6000	-40 °C	100 °C							✓	✓	✓	✓		Clear polyester with permanent acrylic based adhesive; withstands numerous solvents and can be applied to variable surfaces.
B-482	R6400					✓					✓		✓		The B-482 label material, combined with Brady's R6400 ribbon, provides the durability and print quality that histology and anatomic pathology labs need for accurate, identifiable specimen labelling. Paraffin and solvent resistant.
B-488	R4300, R7950	-40 °C	145 °C	✓	✓					✓	✓	✓	✓		Permanent acrylic adhesive; ideal for flat surface; write-on capabilities; excellent solvent resistance and xylene resistance.
B-533	R6000HF	-70 °C	100 °C							✓	✓	✓	✓		Removable, ideal for flat surfaces. Suitable to adhering to glass, but not polypropylene.
B-8423	R6000	-70 °C	110 °C	✓						✓	✓	✓	✓		Permanent acrylic adhesive; semi-gloss finish; excellent for bar code labels.
<b>Polypropylene</b>															
B-425	R6400	-70 °C	80 °C	✓	✓					✓	✓	✓			Excellent solvent resistance.
B-449	R7961	-70 °C	90 °C	✓	✓					✓	✓	✓	✓		Ideal for temporary labelling applications. Removable from flat surfaces; write-on capabilities; Tested 3 cycles of 1 hour in 121°C at 15 psi for autoclave process.
B-7425	R4300	-80 °C	70 °C	✓	✓					✓	✓	✓	✓	✓	For freezer or liquid nitrogen applications, B-7425 must be applied prior to being frozen.

>>

# Choose your Application



Vial/Tube



Conicals/bottles



Slide



Tissue cassette



Straw

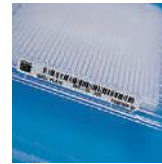

Well Plate



General Lab ID

Material	Printer Ribbon Series	Temp (°C) (Tested for 30 days)		APPLICATION							ENVIRONMENT				OTHER QUALITIES	
				Vial/Tube	Conical / Large Tubes	Slide	Tissue Cassette	Straw	Well Plate	General Lab ID	Freezer	Liquid Nitrogen	Autoclave (121 °C)	Hot Water Bath (100 °C)	Low-Profile (extremely thin)	Additional Features
<b>Self-laminating Polyester</b>																
B-461	R4300, R7950	-196 °C	110 °C	✓	✓			✓				✓	✓	✓	✓	Permanent adhesive; suitable for liquid nitrogen application if material is wrapped around itself, as in self-lamination; write-on capabilities. Temperature range increases to 121 °C when used in autoclave process.
<b>Self-laminating Vinyl</b>																
B-427	R4300	-40 °C	60 °C	✓	✓			✓				✓	✓			Permanent acrylic adhesive; self-laminating; write-on capabilities; suitable for liquid nitrogen application and can be used to identify a frozen vial if label material is wrapped around itself, as in self-lamination. Temperature range goes to -196 °C if material is wrapped around vial and overlaps itself.
<b>StainerBondz™ Polyester</b>																
B-481	R6400	-80 °C	130 °C			✓				✓	✓			✓		White polyester will remain resistant when exposed to xylene and other chemicals that are commonly used in the slide staining process.
<b>Tamper-resistant Vinyl</b>																
B-351	R6200	-40 °C	80 °C							✓	✓	✓				Fractures easily, prevents one-piece removal
B-7351	R6210	-40 °C	80 °C							✓	✓	✓				Tamper-evident with a permanent acrylic adhesive; fractures easily to prevent removal.
<b>Vinyl</b>																
B-439	R6010; R4900; R4410	-70 °C	40 °C							✓	✓	✓				Available in Blue, Green, Orange, Red, White and Yellow
B-595	R6000; R4400; R6900	-40 °C	82 °C							✓	✓	✓				Available in a wide range of colours.
<b>Vinyl Cloth</b>																
B-498	R4300	-40 °C	80 °C	✓	✓	✓		✓	✓	✓						Removable from flat surfaces; write-on capabilities. Available in White.



## Part number explanation

Most Brady references for printable labels follow the same three-part format: The first code indicates the technology, the second part is a number indicating the label size (where applicable) and the third part indicates the Brady material (where applicable).

# M71-73-461

BMP71  
Technology

Label size  
code

Material  
(B-number)



## VIAL / TUBE LABELS

Brady's vial and test tube labels are designed to withstand extreme laboratory solvents like Xylene, Ethanol, Alcohol and DMSO, ensuring that the specimen identification is always legible - and will not smear, fade or fall off.

- F** Freezer environment
- A** Autoclave environment
- H** Hot water bath (100°C)
- S** Self-laminating label
- L** Low-profile (extremely thin) label
- R** Removable

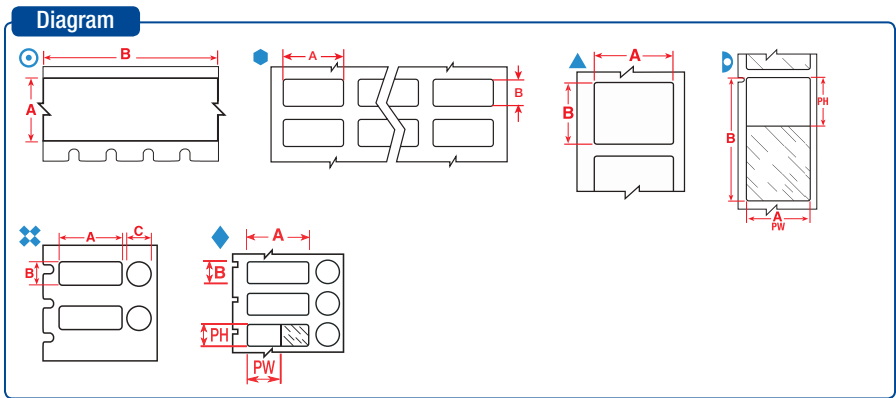

Labels are shown per vial / tube size and in order of label width.

The background colours in the Order Reference column represent the material colour.

See page 42 for Brady's range of label printers.

Diagram	Material	Special Properties	Label Width A (mm)	Label Height B (mm)	Label Length B (m)	Diameter C (mm)	Printable Area Width PW (mm)	Printable Area Height PH (mm)	Order Reference	Printer Compatibility	Printer Ribbon Series	Labels per Roll	Labels per Row
<b>0.5 ml</b>													
⊙	B-423	<b>F A H</b>	6.35	—	6.40	—	—	—	M21-250-423	BMP21-LAB	—	1	1
▷	B-427	<b>F N S</b>	25.40	63.50	—	—	25.40	19.05	PTL-21-427	BMP61, BMP71	R4310	100	1
<b>0.5 - 0.7 ml</b>													
▷	B-461	<b>F N A H S L</b>	9.53	45.72	—	—	9.53	19.05	M71-73-461	BMP71	M71-R6200	250	1
⬢	B-499	<b>F N A</b>	12.70	19.05	—	—	—	—	B33-68-499	BBP33	B30-R6000HF	1500	4
⬢	B-498	<b>F R</b>	12.70	19.05	—	—	—	—	B33-68-498	BBP33	B30-R6200	5000	4
⬢	B-490	<b>F N H L</b>	12.70	19.05	—	—	—	—	B33-68-490	BBP33	B30-R4300	2500	4
⬢	B-499	<b>F N A</b>	12.70	19.05	—	—	—	—	THT-68-499-10	BBP12, BP-PR+, IP, i7100, i5100	R4900	10000	4
⬢	B-498	<b>F R</b>	12.70	19.05	—	—	—	—	THT-68-498-10	BBP12, BP-PR+, IP, i7100, i5100	R4300, R7950	10000	4
▲	B-499	<b>F N A</b>	12.70	25.40	—	—	—	—	B33-620-499	BBP33	B30-R6000HF	1000	1
▲	B-499	<b>F N A</b>	12.70	25.40	—	—	—	—	BPT-620-499	BBP12, BP-PR+	R7950	1000	1
▷	B-461	<b>F N A H S L</b>	12.70	55.88	—	—	12.70	19.05	B33-127-461	BBP33	B30-R4300	1500	3
▷	B-461	<b>F N A H S L</b>	12.70	55.88	—	—	12.70	19.05	THT-127-461-3*	BBP12, BP-PR+, IP, i7100, i5100	R4300, R7950	3000	1
▷	B-461	<b>F N A H S L</b>	12.70	55.88	—	—	12.70	19.05	THT-127-461-1.5-SC*	BBP12, BP-PR+	R7950	1500	1
▷	B-427	<b>F N S</b>	12.70	55.88	—	—	12.70	19.05	THT-127-427-3*	BBP12, BP-PR+, IP, i7100, i5100	R4300, R7950	3000	1
▲	B-498	<b>F R</b>	19.05	12.70	—	—	—	—	BM71-11-498	BMP61, BMP71	R6200	5000	1
▲	B-498	<b>F R</b>	19.05	12.70	—	—	—	—	M71-11-498	BMP71	M71-R6200	500	1
◆	B-461	<b>F A H S L</b>	25.40	9.53	—	9.53	20.00	9.53	BPT-606-461	BBP12, BP-PR+	R7950	1000	1
⬢	B-499	<b>F N A</b>	25.40	9.53	—	—	—	—	B33-152-499	BBP33	B30-R6000HF	1500	2
⬢	B-492	<b>F N H L</b>	25.40	9.53	—	—	—	—	B33-152-492	BBP33	B30-R6400	2500	2
⊗	B-499	<b>F A</b>	25.40	9.53	—	9.53	—	—	M71-98-499	BMP71	M71-R4300	500	1
▲	B-492	<b>F N H L</b>	25.40	9.53	—	—	—	—	M71-16-492	BMP71	M71-R6400	500	1
⬢	B-499	<b>F N A</b>	25.40	9.53	—	—	—	—	THT-152-499-3	BBP12, BP-PR+, IP, i7100, i5100	R4900	3000	2
⬢	B-499	<b>F N A</b>	25.40	9.53	—	—	—	—	THT-152-499-1.5-SC	BBP12, BP-PR+	R7950	1500	2
⬢	B-492	<b>F N H L</b>	25.40	9.53	—	—	—	—	THT-152-492-3	BBP12, BP-PR+, IP, i7100, i5100	R6400	3000	2
▲	B-492	<b>F N H L</b>	25.40	9.53	—	—	—	—	THT-152-492-2.5-SC	BBP12, BP-PR+	R6400	2500	2
⬢	B-425	<b>F</b>	25.40	9.98	—	—	—	—	THT-30-425-10	BBP12, BP-PR+, IP, i7100, i5100	R6400	10000	3

\*Label is rotated 90° on liner.

>>>

**F** Freezer environment **N** Liquid nitrogen environment **A** Autoclave environment **H** Hot water bath (100°C) **S** Self-laminating label **L** Low-profile (extremely thin) label **R** Removable



## Diagram

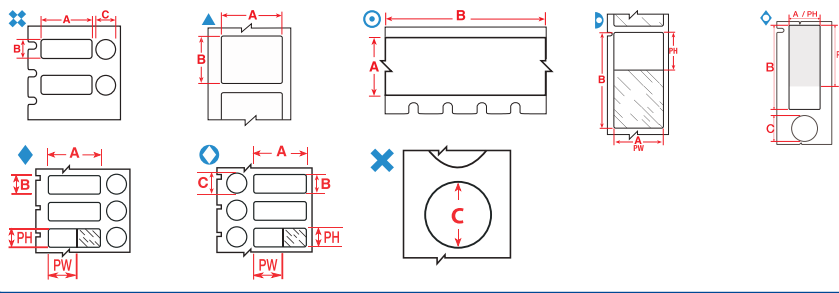

Labels are shown per vial / tube size and in order of label width.

The background colours in the Order Reference column represent the material colour.

See page 42 for Brady's range of label printers.

Diagram	Material	Special Properties	Label Width A (mm)	Label Height B (mm)	Label Length B (m)	Diameter C (mm)	Printable Area Width PW (mm)	Printable Area Height PH (mm)	Order Reference	Printer Compatibility	Printer Ribbon Series	Labels per Roll	Labels per Row
<b>0.5 - 8.0 ml</b>													
❖	B-499	<b>F A</b>	25.40	9.53	-	9.53	-	-	THT-249-499-1.5-SC	BBP12, BP-PR+	R7950	1500	1
❖	B-492	<b>F H L</b>	25.40	9.53	-	9.53	-	-	THT-249-492-1.5-SC	BBP12, BP-PR+	R6400	1500	1
❖	B-492	<b>F H L</b>	25.40	12.70	-	11.18	-	-	THT-251-492-1.5-SC	BBP12, BP-PR+	R6400	1500	1
❖	B-492	<b>F H L</b>	25.40	12.70	-	9.53	-	-	THT-250-492-1.5-SC	BBP12, BP-PR+	R6400	1500	1
<b>0.6 ml</b>													
⊙	B-499	<b>F N A</b>	9.53	-	4.88	-	-	-	M21-375-499	BMP21-LAB	-	1	1
⊙	B-499	<b>F N A</b>	9.53	-	4.88	-	-	-	MC-375-499	BMP51, BMP53	-	1	1
⊙	B-461	<b>F N A H S L</b>	9.53	-	6.40	-	9.53	-	M21-375-461-AW**	BMP21-LAB	-	1	1
⊙	B-7425	<b>F N A H</b>	9.53	-	6.40	-	-	-	M21-375-7425	BMP21-LAB	-	1	1
▲	B-499	<b>F N A</b>	22.86	12.70	-	-	-	-	B33-125-499	BBP33	B30-R6000HF	1500	1
▲	B-490	<b>F N H L</b>	22.86	12.70	-	-	-	-	B33-125-490	BBP33	B30-R4300	1650	1
▲	B-499	<b>F N A</b>	22.86	12.70	-	-	-	-	M71-84-499	BMP71	M71-R4300	500	1
▲	B-499	<b>F N A</b>	22.86	12.70	-	-	-	-	THT-125-499-3	BBP12, BP-PR+, IP, i7100, i5100	R4900	3000	1
▲	B-499	<b>F N A</b>	22.86	12.70	-	-	-	-	THT-125-499-1.5-SC	BBP12, BP-PR+	R7950	1500	1
<b>0.6 - 1.5 ml</b>													
❖	B-499	<b>F A</b>	25.40	9.53	-	9.53	-	-	PTL-98-499	BMP61, BMP71	R4310	500	1
❖	B-499	<b>F N A</b>	-	-	-	9.53	-	-	PTL-82-499	BMP61, BMP71	R4310	500	1
❖	B-499	<b>F N A</b>	-	-	-	9.53	-	-	PTL-82-499-YL	BMP61, BMP71	R4310	500	1
<b>1.0 - 2.0 ml</b>													
▷	B-461	<b>F N A H S L</b>	15.00	40.00	-	-	15.00	30.00	BPTLAB-21-461-2.5	BBP12, BP-PR+	R7950	2500	1
▷	B-461	<b>F N A H S L</b>	15.24	38.10	-	-	15.24	33.00	BPT-628-461*	BBP12, BP-PR+	R7950	2500	2
▷	B-461	<b>F N A H S L</b>	15.24	38.10	-	-	15.24	33.00	M71-100-461	BMP71	M71-R6200	500	1
▷	B-461	<b>F N A H S L</b>	15.24	38.10	-	-	15.24	33.03	B33-628-461*	BBP33	B30-R4300	2500	2
◇	B-461	<b>F A H S L</b>	15.24	41.28	-	12.70	15.24	30.00	M71-116-461	BMP71	M71-R6200	150	1
▷	B-461	<b>F N A H S L</b>	15.24	66.68	-	-	15.24	25.40	B33-612-461	BBP33	B30-R4300	1500	3
▷	B-461	<b>F N A H S L</b>	15.24	66.68	-	-	15.24	25.40	BPT-612-461	BBP12, BP-PR+	R7950	1500	3
❖	B-499	<b>F A</b>	25.40	9.53	-	9.53	-	-	B33-163-499	BBP33	B30-R6000HF	1500	1
❖	B-492	<b>F H L</b>	25.40	9.53	-	9.53	-	-	B33-163-492	BBP33	B30-R6400	1500	1
❖	B-499	<b>F A</b>	25.40	9.53	-	9.53	-	-	THT-163-499-3	BBP12, BP-PR+, IP, i7100, i5100	R4900	3000	1
❖	B-492	<b>F H L</b>	25.40	9.53	-	9.53	-	-	THT-163-492-3	BBP12, BP-PR+, IP, i7100, i5100	R6400	3000	1
❖	B-492	<b>F H L</b>	25.40	12.70	-	11.18	-	-	B33-182-492	BBP33	B30-R6400	1500	1
❖	B-492	<b>F H L</b>	25.40	12.70	-	9.53	-	-	B33-181-492	BBP33	B30-R6400	1500	1
❖	B-492	<b>F H L</b>	25.40	12.70	-	9.53	-	-	M71-118-492	BMP71	M71-R6400	500	1
❖	B-492	<b>F H L</b>	25.40	12.70	-	11.18	-	-	THT-182-492-3	BBP12, BP-PR+, IP, i7100, i5100	R6400	3000	1
❖	B-492	<b>F H L</b>	25.40	12.70	-	9.53	-	-	THT-181-492-3	BP-PR+, IP, i7100, i5100	R6400	3000	1
▷	B-461	<b>F N A H S L</b>	25.40	44.45	-	-	25.40	25.40	B33-183-461	BBP33	B30-R4300	2000	1
▷	B-461	<b>F N A H S L</b>	25.40	44.45	-	-	25.40	25.40	M71-106-461	BMP71	M71-R6200	250	1
▷	B-461	<b>F N A H S L</b>	25.40	44.45	-	-	25.40	25.40	THT-183-461-1	BBP12, BP-PR+, IP, i7100, i5100	R4300, R7950	1000	1
◆	B-461	<b>F A H S L</b>	40.00	15.00	-	9.00	30.00	15.00	BPTLAB-20-461-2.5	BBP12, BP-PR+	R7950	2500	1
◆	B-461	<b>F A H S L</b>	40.00	15.00	-	9.53	30.00	15.00	M71-101-461	BMP71	M71-R6200	250	1
◇	B-461	<b>F A H S L</b>	41.28	15.24	-	12.70	30.00	15.24	B33-608-461	BBP33	B30-R4300	1000	1
◆	B-461	<b>F A H S L</b>	41.28	15.24	-	12.70	30.00	15.24	BPT-608-461	BBP12, BP-PR+	R7950	1000	1
❖	B-499	<b>F A</b>	41.28	15.24	-	12.70	-	-	BPT-608-499	BBP12, BP-PR+	R7950	1000	1
❖	B-499	<b>F N A</b>	-	-	-	12.70	-	-	PTL-83-499	BMP61, BMP71	R4310	500	1
❖	B-499	<b>F N A</b>	-	-	-	12.70	-	-	PTL-83-499-YL	BMP61, BMP71	R4310	500	1

\*Label is rotated 90° on liner. \*\*AW = All White / no transparent area.

>>

**F** Freezer environment **N** Liquid nitrogen environment **A** Autoclave environment **H** Hot water bath (100°C) **S** Self-laminating label **L** Low-profile (extremely thin) label **R** Removable

# Vial / Tube Labels

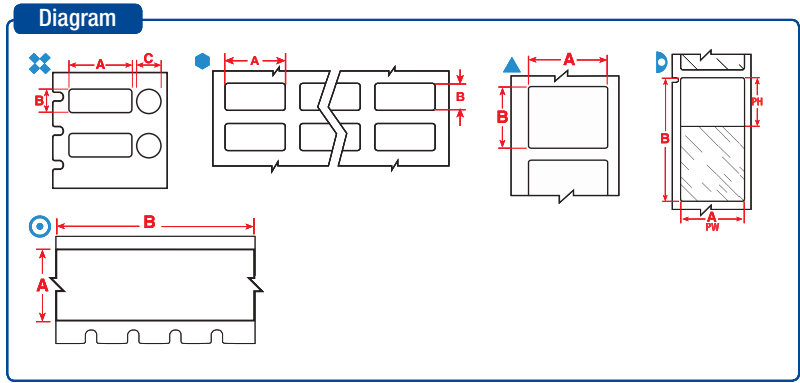

Labels are shown per vial / tube size and in order of label width.

The background colours in the Order Reference column represent the material colour.

See page 42 for Brady's range of label printers.

Diagram	Material	Special Properties	Label Width A (mm)	Label Height B (mm)	Label Length B (m)	Diameter C (mm)	Printable Area Width PW (mm)	Printable Area Height PH (mm)	Order Reference	Printer Compatibility	Printer Ribbon Series	Labels per Roll	Labels per Row
<b>1.0 - 8.0 ml</b>													
▷	B-461	<b>F N A H S L</b>	15.24	41.28	-	-	15.24	25.40	M71-76-461	BMP71	M71-R6200	500	1
▷	B-461	<b>F N A H S L</b>	15.24	66.68	-	-	15.24	25.40	B33-153-461*	BBP33	B30-R4300	1500	1
▷	B-461	<b>F N A H S L</b>	15.24	66.68	-	-	15.24	25.40	M71-86-461	BMP71	M71-R6200	100	1
⬢	B-498	<b>F</b>	19.05	23.80	-	-	-	-	B33-91-498	BBP33	B30-R6200	2500	4
⬢	B-498	<b>F</b>	19.05	23.80	-	-	-	-	THT-91-498-5	BBP12, BP-PR+, IP, i7100, i5100	R4300, R7950	5000	4
⊗	B-490	<b>F H L</b>	22.86	12.70	-	12.70	-	-	B33-126-490	BBP33	B30-R4300	2500	1
⊗	B-499	<b>F A</b>	22.86	12.70	-	12.70	-	-	M71-126-499	BMP71	M71-R4300	500	1
▲	B-499	<b>F N A</b>	22.86	12.70	-	-	-	-	PTL-84-499	BMP61, BMP71	R4310	500	1
⊗	B-499	<b>F A</b>	22.86	12.70	-	12.70	-	-	THT-126-499-3	BP-PR+, IP, i7100, i5100	R4900	3000	1
⬢	B-498	<b>F</b>	25.40	19.05	-	-	-	-	B33-88-498	BBP33	B30-R6200	2500	2
▲	B-498	<b>F</b>	25.40	19.05	-	-	-	-	BM71-18-498	BMP61, BMP71	R6200	2500	1
▲	B-498	<b>F</b>	25.40	19.05	-	-	-	-	M-48-498	BMP51, BMP53	-	180	1
▲	B-499	<b>F N A</b>	25.40	19.05	-	-	-	-	M71-18-499	BMP71	M71-R4300	250	1
▲	B-498	<b>F</b>	25.40	19.05	-	-	-	-	M71-18-498	BMP71	M71-R6200	250	1
⬢	B-498	<b>F</b>	25.40	19.05	-	-	-	-	THT-88-498-5	BBP12, BP-PR+, IP, i7100, i5100	R4300, R7950	5000	2
⬢	B-492	<b>F N H L</b>	25.40	19.05	-	-	-	-	THT-88-492-5	BBP12, BP-PR+, IP, i7100, i5100	R6400	5000	2
▲	B-492	<b>F N H L</b>	25.40	19.05	-	-	-	-	THT-88-492-2.5-SC	BBP12, BP-PR+	R6400	2500	2
▷	B-461	<b>F N A H S L</b>	25.40	66.68	-	-	25.40	25.40	BM71-75-461	BMP61, BMP71	R6200	1000	1
▷	B-461	<b>F N A H S L</b>	25.40	66.68	-	-	25.40	25.40	M71-115-461	BMP71	M71-R6200	100	1
▷	B-461	<b>F N A H S L</b>	25.40	66.68	-	-	25.40	25.40	PTL-75-461	BMP61, BMP71	R4310	100	1
▷	B-461	<b>F N A H S L</b>	25.40	66.68	-	-	25.40	25.40	<b>PTL-75-461-YL</b>	BMP61, BMP71	R4310	100	1
▷	B-427	<b>F N S</b>	25.40	66.68	-	-	25.40	25.40	PTL-75-427	BMP61, BMP71	R4310	100	1
▷	B-461	<b>F N A H S L</b>	25.40	66.68	-	-	25.40	25.40	THT-131-461-3*	BBP12, BP-PR+, IP, i7100, i5100	R4300, R7950	3000	1
▷	B-461	<b>F N A H S L</b>	25.40	66.68	-	-	25.40	25.40	THT-131-461-1.5-SC*	BBP12, BP-PR+	R7950	1500	1
▷	B-427	<b>F N S</b>	25.40	66.68	-	-	25.40	25.40	THT-131-427-3*	BBP12, BP-PR+, IP, i7100, i5100	R4300, R7950	3000	1
⊗	B-492	<b>F H L</b>	41.28	15.24	-	9.53	-	-	B33-190-492	BBP33	R6400	1500	1
▲	B-492	<b>F N H L</b>	41.28	15.24	-	-	-	-	B33-155-492	BBP33	R6400	1500	1
▲	B-490	<b>F N H L</b>	41.28	15.24	-	-	-	-	B33-155-490	BBP33	B30-R4300	1500	1
▲	B-490	<b>F N H L</b>	41.28	15.24	-	-	-	-	M71-76-490	BMP71	M71-R4300	500	1
⊗	B-492	<b>F H L</b>	41.28	15.24	-	9.53	-	-	THT-190-492-3	BBP12, BP-PR+, IP, i7100, i5100	R6400	3000	1
▲	B-492	<b>F N H L</b>	41.28	15.24	-	-	-	-	THT-155-492-3	BBP12, BP-PR+, IP, i7100, i5100	R6400	3000	1
▲	B-490	<b>F N H L</b>	41.28	15.24	-	-	-	-	THT-155-490-3	BBP12, BP-PR+, IP, i7100, i5100	R4300, R7950	3000	1
▲	B-490	<b>F N H L</b>	41.28	15.24	-	-	-	-	THT-155-490-1.5-SC	BBP12, BP-PR+	R7950	1500	1
▲	B-492	<b>F N H L</b>	44.45	25.40	-	-	-	-	M-125-492	BMP51, BMP53	-	180	1
▲	B-492	<b>F N H L</b>	48.26	25.40	-	-	-	-	B33-156-492	BBP33	B30-R6400	1500	1
▲	B-490	<b>F N H L</b>	48.26	25.40	-	-	-	-	B33-156-490	BBP33	B30-R4300	1500	1
▲	B-492	<b>F N H L</b>	48.26	25.40	-	-	-	-	M71-78-492	BMP71	M71-R6400	250	1
▲	B-490	<b>F N H L</b>	48.26	25.40	-	-	-	-	PTL-78-490	BMP61, BMP71	R4310	250	1
▲	B-492	<b>F N H L</b>	48.26	25.40	-	-	-	-	THT-156-492-3	BBP12, BP-PR+, IP, i7100, i5100	R6400	3000	1
▲	B-492	<b>F N H L</b>	48.26	25.40	-	-	-	-	BBP12, BP-PR+	R6400	1500	1	
▲	B-490	<b>F N H L</b>	48.26	25.40	-	-	-	-	THT-156-490-3	BBP12, BP-PR+, IP, i7100, i5100	R4300, R7950	3000	1
▲	B-490	<b>F N H L</b>	48.26	25.40	-	-	-	-	THT-156-490-1.5-SC	BBP12, BP-PR+	R7950	1500	1
▷	B-427	<b>F N S</b>	66.68	25.40	-	-	25.40	25.40	B33-131-427	BBP33	B30-R4300	1500	1

\*Label is rotated 90° on liner. \*\*AW = All White / no transparent area.

>>>

**F** Freezer environment **N** Liquid nitrogen environment **A** Autoclave environment **H** Hot water bath (100°C) **S** Self-laminating label **L** Low-profile (extremely thin) label **R** Removable

## Diagram

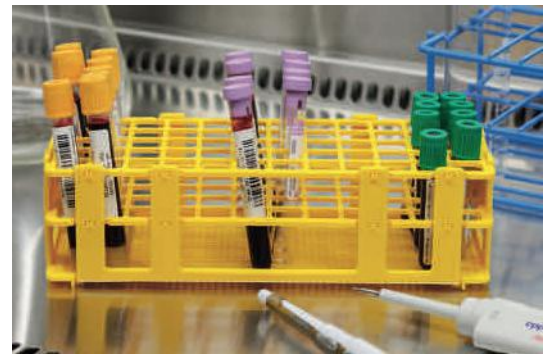
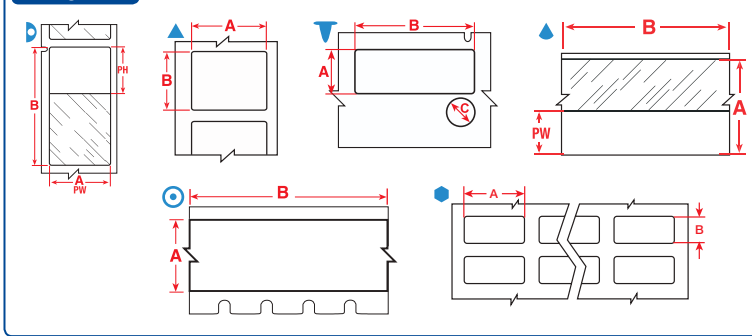

Labels are shown per vial / tube size and in order of label width.

The background colours in the Order Reference column represent the material colour.

See page 42 for Brady's range of label printers.

Diagram	Material	Special Properties	Label Width A (mm)	Label Height B (mm)	Label Length B (m)	Diameter C (mm)	Printable Area Width PW (mm)	Printable Area Height PH (mm)	Order Reference	Printer Compatibility	Printer Ribbon Series	Labels per Roll	Labels per Row
<b>1.5 ml</b>													
⊙	B-499	<b>FNA</b>	12.70	–	4.88	–	–	–	M21-500-499	BMP21-LAB	–	1	1
⊙	B-499	<b>FNA</b>	12.70	–	4.88	–	–	–	MC-500-499	BMP51, BMP53	–	1	1
⊙	B-461	<b>FNAHSL</b>	12.70	–	6.40	–	12.70	–	M21-500-461-AW**	BMP21-LAB	–	1	1
⊙	B-7425	<b>FNAH</b>	12.70	–	6.40	–	–	–	M21-500-7425	BMP21-LAB	–	1	1
⊙	B-499	<b>FNA</b>	12.70	–	9.10	–	–	–	M71C-500-499	BMP71	M71-R4300	1	1
<b>1.5 - 2.0 ml</b>													
▷	B-461	<b>FNAHSL</b>	15.24	41.28	–	–	15.24	25.40	THT-133-461-3*	BBP12, BP-PR+, IP, i7100, i5100	R4300, R7950	3000	1
▷	B-461	<b>FNAHSL</b>	15.24	41.28	–	–	15.24	25.40	B33-133-461	BBP33	B30-R4300	1500	3
▷	B-461	<b>FNAHSL</b>	15.24	41.28	–	–	15.24	25.40	THT-133-461-1.5-SC*	BBP12, BP-PR+	R7950	1500	1
▷	B-461	<b>FNAHSL</b>	15.24	66.68	–	–	15.24	25.40	THT-153-461-3*	BBP12, BP-PR+, IP, i7100, i5100	R4300, R7950	3000	1
▷	B-461	<b>FNAHSL</b>	15.24	66.68	–	–	15.24	25.40	THT-153-461-1.5-SC*	BBP12, BP-PR+	R7950	1500	1
▲	B-492	<b>FNHL</b>	25.40	12.70	–	–	–	–	B33-59-492	BBP33	B30-R6400	2500	1
▲	B-492	<b>FNHL</b>	25.40	12.70	–	–	–	–	THT-59-492-10	BBP12, BP-PR+, IP, i7100, i5100	R6400	10000	1
▲	B-492	<b>FNHL</b>	25.40	12.70	–	–	–	–	THT-59-492-2.5-SC	BBP12, BP-PR+	R6400	2500	1
▼	B-492	<b>FHL</b>	41.28	15.24	–	9.53	–	–	M-95-492	BMP51, BMP53	–	200	1
▲	B-492	<b>FNHL</b>	41.91	12.70	–	–	–	–	M-124-492	BMP51, BMP53	–	180	1
<b>2.0 - 4.0 ml</b>													
▷	B-461	<b>FNAHSL</b>	15.24	48.26	–	–	15.24	40.00	B33-638-461*	BBP33	B30-R4300	2000	1
▷	B-461	<b>FNAHSL</b>	15.24	48.26	–	–	15.24	40.00	BPT-638-461*	BBP12, BP-PR+	R7950	2000	1
▷	B-461	<b>FNAHSL</b>	15.24	48.26	–	–	15.24	40.00	M71-119-461	BMP71	M71-R6200	500	1
<b>2.0 - 50.0 ml</b>													
▲	B-427	<b>FN S</b>	19.05	–	4.30	–	9.53	–	M21-750-427	BMP21-LAB	–	1	–
⊙	B-499	<b>FNA</b>	19.05	–	4.88	–	–	–	M21-750-499	BMP21-LAB	–	1	1
⊙	B-499	<b>FNA</b>	19.05	–	4.88	–	–	–	MC-750-499	BMP51, BMP53	–	1	1
⊙	B-461	<b>FNAHSL</b>	19.05	–	6.40	–	19.05	–	M21-750-461-AW**	BMP21-LAB	–	1	1
⊙	B-7425	<b>FNAH</b>	19.05	–	6.40	–	–	–	M21-750-7425	BMP21-LAB	–	1	1
▲	B-427	<b>FN S</b>	19.05	–	7.62	–	9.53	–	MC-750-427	BMP51, BMP53	–	1	1
⊙	B-499	<b>FNA</b>	25.40	–	4.88	–	–	–	MC-1000-499	BMP51, BMP53	–	1	1
⊙	B-499	<b>FNA</b>	25.40	–	9.10	–	–	–	M71C-1000-499	BMP71	M71-R4300	1	1
<b>4.0 - 8.0 ml</b>													
⬢	B-499	<b>FNA</b>	25.40	66.68	–	–	–	–	B33-625-499	BBP33	B30-R6000HF	1500	3
⬢	B-499	<b>FNA</b>	25.40	66.68	–	–	–	–	BPT-625-499	BBP12, BP-PR+	R7950	1500	3
<b>4.0 - 50.0 ml</b>													
▷	B-461	<b>FNAHSL</b>	34.93	45.72	–	–	34.93	40.00	B33-632-461*	BBP33	B30-R4300	1500	1
▷	B-461	<b>FNAHSL</b>	34.93	45.72	–	–	34.93	40.00	BPT-632-461*	BBP12, BP-PR+	R7950	2000	1
<b>5.0 - 50.0 ml</b>													
⊙	B-499	<b>FNA</b>	48.26	–	9.10	–	–	–	M71C-1900-499	BMP71	M71-R4300	1	1

\*Label is rotated 90° on liner. \*\*AW = All White / no transparent area.

>>

# Vial / Tube Labels

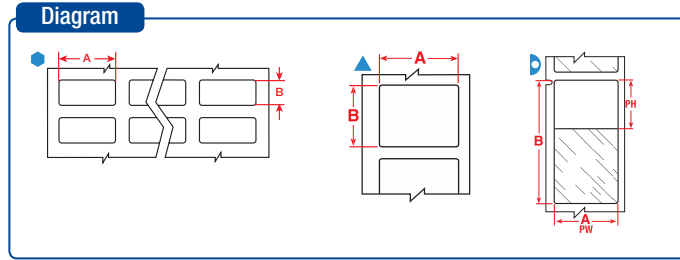

Labels are shown per vial / tube size and in order of label width.

The background colours in the Order Reference column represent the material colour.

See page 42 for Brady's range of label printers.

Diagram	Material	Special Properties	Label Width A (mm)	Label Height B (mm)	Label Length B (m)	Diameter C (mm)	Printable Area Width PW (mm)	Printable Area Height PH (mm)	Order Reference	Printer Compatibility	Printer Ribbon Series	Labels per Roll	Labels per Row
<b>12.0 - 24.0 ml</b>													
⬡	B-498	<b>F</b>	12.70	36.50	-	-	-	-	B33-87-498	BBP33	B30-R6200	2500	6
⬡	B-498	<b>F</b>	12.70	36.50	-	-	-	-	THT-87-498-5	BBP12, BP-PR+, IP, i7100, i5100	R4300, R7950	5000	6
▶	B-461	<b>FNAHSL</b>	19.05	95.25	-	-	19.05	25.40	PTL-79-461	BMP61, BMP71	R4310	100	1
▲	B-498	<b>F</b>	38.10	12.70	-	-	-	-	BM71-29-498	BMP61, BMP71	R6200	5000	1
<b>12.0 - 50.0 ml</b>													
▶	B-461	<b>FNAHSL</b>	25.40	133.35	-	-	25.40	38.10	B33-139-461	BBP33	B30-R4300	650	2
▶	B-461	<b>FNAHSL</b>	25.40	133.35	-	-	25.40	38.10	THT-139-461-2	BBP12, BP-PR+, IP, i7100, i5100	R4300, R7950	2000	2
<b>14.0 - 15.0 ml</b>													
▲	B-490	<b>FNHL</b>	55.88	38.10	-	-	-	-	THT-157-490-3	BBP12, BP-PR+, IP, i7100, i5100	R4300, R7950	3000	1
▲	B-490	<b>FNHL</b>	55.88	38.10	-	-	-	-	THT-157-490-1.5-SC	BBP12, BP-PR+	R7950	1500	1
<b>15.0 - 50.0 ml</b>													
⬡	B-499	<b>FNA</b>	12.70	25.40	-	-	-	-	B33-611-499	BBP33	B30-R6000HF	3000	3
⬡	B-499	<b>FNA</b>	12.70	25.40	-	-	-	-	BPT-611-499	BBP12, BP-PR+	R7950	3000	3
⬡	B-498	<b>F</b>	12.70	25.40	-	-	-	-	BPT-611-498	BBP12, BP-PR+	R7950	3000	3
▲	B-499	<b>FNA</b>	25.40	12.40	-	-	-	-	B33-659-499	BBP33	B30-R6000HF	1000	1
▲	B-499	<b>FNA</b>	25.40	12.40	-	-	-	-	BPT-659-499	BBP12, BP-PR+	R7950	1000	1
▲	B-498	<b>F</b>	25.40	12.40	-	-	-	-	BPT-659-498	BBP12, BP-PR+	R7950	1000	1
⬡	B-499	<b>FNA</b>	25.40	36.50	-	-	-	-	B33-621-499	BBP33	B30-R6000HF	3000	3
⬡	B-498	<b>F</b>	25.40	36.50	-	-	-	-	B33-89-498	BBP33	B30-R6200	2300	3
⬡	B-499	<b>FNA</b>	25.40	36.50	-	-	-	-	BPT-621-499	BBP12, BP-PR+	R7950	3000	3
▶	B-461	<b>FNAHSL</b>	25.40	66.68	-	-	25.40	25.40	B33-276-461	BBP33	B30-R4300	1500	2
▶	B-461	<b>FNAHSL</b>	38.10	88.90	-	-	38.10	31.75	B33-134-461*	BBP33	B30-R4300	1000	1
▶	B-461	<b>FNAHSL</b>	38.10	88.90	-	-	38.10	31.75	THT-134-461-3*	BBP12, BP-PR+, IP, i7100, i5100	R4300, R7950	3000	1
<b>50.0 ml</b>													
▲	B-492	<b>FNHL</b>	22.86	25.40	-	-	-	-	B33-180-492	BBP33	B30-R6400	1500	1
▲	B-492	<b>FNHL</b>	22.86	25.40	-	-	-	-	THT-180-492-3	BBP12, BP-PR+, IP, i7100, i5100	R6400	3000	1
⬡	B-498	<b>F</b>	25.40	12.70	-	-	-	-	B33-5-498	BBP33	B30-R6200	5000	3
⬡	B-425	<b>F</b>	25.40	12.70	-	-	-	-	B33-5-425	BBP33	B30-R4300	5000	3
⬡	B-425	<b>F</b>	25.40	12.70	-	-	-	-	THT-5-425-10	BBP12, BP-PR+, IP, i7100, i5100	R6400	10000	3
▲	B-492	<b>FNHL</b>	25.40	25.40	-	-	-	-	B33-179-492	BBP33	B30-R6400	1900	1
▲	B-492	<b>FNHL</b>	25.40	25.40	-	-	-	-	THT-179-492-3	BBP12, BP-PR+, IP, i7100, i5100	R6400	3000	1
▲	B-492	<b>FNHL</b>	25.40	25.40	-	-	-	-	THT-179-492-2.5-SC	BBP12, BP-PR+	R6400	2500	1
▲	B-499	<b>FNA</b>	25.40	63.50	-	-	-	-	M71-21-499	BMP71	M71-R4300	100	1
▲	B-490	<b>FNHL</b>	50.80	6.35	-	-	-	-	B33-151-490	BBP33	B30-R4300	2500	1

\*Label is rotated 90° on liner.

**F** Freezer environment **N** Liquid nitrogen environment **A** Autoclave environment **H** Hot water bath (100°C) **S** Self-laminating label **L** Low-profile (extremely thin) label **R** Removable

## VIAL TOP LABELS

Save time by using the Vial and Vial top combination labels - print your information in one go.

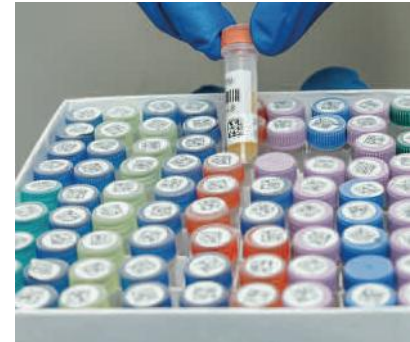
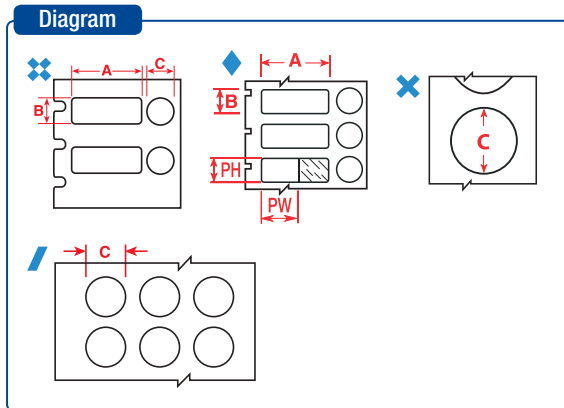

- F** Freezer environment
- A** Autoclave environment
- H** Hot water bath (100°C)
- S** Self-laminating label
- L** Low-profile (extremely thin) label
- R** Removable

Labels are shown per vial / tube size and in order of label width.

The background colours in the Order Reference column represent the material colour.

See page 42 for Brady's range of label printers.

Diagram	Material	Special Properties	Label Width A (mm)	Label Height B (mm)	Diameter C (mm)	Printable Area Width PW (mm)	Printable Area Height PH (mm)	Order Reference	Printer Compatibility	Printer Ribbon Series	Labels per Roll	Labels per Row
<b>0.5 - 0.7 ml</b>												
◆	B-461	<b>F A H S L</b>	25.40	9.53	9.53	20.00	9.53	B33-606-461	BBP33	B30-R4300	1000	1
◆	B-461	<b>F A H S L</b>	25.40	9.53	9.53	20.00	9.53	BPT-606-461	BBP12, BP-PR+	R7950	1000	1
✦	B-499	<b>F A</b>	25.40	9.53	9.53	-	-	M71-98-499	BMP71	M71-R4300	500	1
<b>0.5 - 1.5 ml</b>												
✦	B-499	<b>F A</b>	-	-	9.53	-	-	M-82-499	BMP51, BMP53	-	240	1
✦	B-499	<b>F A</b>	-	-	9.53	-	-	M-82-499-OR-BK	BMP51, BMP53	-	240	1
✦	B-499	<b>F A</b>	-	-	9.53	-	-	M-82-499-RD-BK	BMP51, BMP53	-	240	1
✦	B-499	<b>F A</b>	-	-	9.53	-	-	M-82-499-YL-BK	BMP51, BMP53	-	240	1
✦	B-492	<b>F H L</b>	-	-	9.53	-	-	M-82-492	BMP51, BMP53	-	240	1
<b>0.5 - 8.0 ml</b>												
✦	B-499	<b>F A</b>	25.40	9.53	9.53	-	-	THT-249-499-1.5-SC	BBP12, BP-PR+	R7950	1500	1
✦	B-492	<b>F H L</b>	25.40	9.53	9.53	-	-	THT-249-492-1.5-SC	BBP12, BP-PR+	R6400	1500	1
✦	B-492	<b>F H L</b>	25.40	12.70	9.53	-	-	THT-250-492-1.5-SC	BBP12, BP-PR+	R6400	1500	1
✦	B-492	<b>F H L</b>	25.40	12.70	11.18	-	-	THT-251-492-1.5-SC	BBP12, BP-PR+	R6400	1500	1
<b>0.6 - 1.5 ml</b>												
/	B-499	<b>F A</b>	-	-	9.53	-	-	B33-143-499	BBP33	B30-R6000HF	1500	4
/	B-492	<b>F H L</b>	-	-	9.53	-	-	B33-143-492	BBP33	B30-R6400	1500	4
✦	B-499	<b>F A</b>	-	-	9.53	-	-	M71-82-499	BMP71	M71-R4300	500	1
/	B-499	<b>F A</b>	-	-	9.53	-	-	THT-143-499-3	BBP12, BP-PR+, IP, i7100, i5100	R4900	3000	4
/	B-492	<b>F H L</b>	-	-	9.53	-	-	THT-143-492-3	BBP12, BP-PR+, IP, i7100, i5100	R6400	3000	4
/	B-492	<b>F H L</b>	-	-	9.53	-	-	THT-143-492-1.5-SC	BBP12, BP-PR+	R6400	1500	4
<b>0.6 - 50.0 ml</b>												
/	B-499	<b>F A</b>	-	-	9.53	-	-	B33-602-499	BBP33	B30-R6000HF	3000	3
/	B-499	<b>F A</b>	-	-	9.53	-	-	B33-602-499YL	BBP33	B30-R6000HF	3000	3
/	B-461	<b>F A H S L</b>	-	-	9.53	-	-	B33-602-461AW**	BBP33	B30-R4300	3000	3
/	B-499	<b>F A</b>	-	-	9.53	-	-	BPT-602-499	BBP12, BP-PR+	R7950	3000	3
/	B-499	<b>F A</b>	-	-	9.53	-	-	BPT-602-499YL	BBP12, BP-PR+	R7950	3000	3
✦	B-461	<b>F A H S L</b>	-	-	9.53	-	-	BPT-602-461AW**	BBP12, BP-PR+	R7950	3000	3
/	B-499	<b>F A</b>	-	-	12.70	-	-	B33-603-499	BBP33	B30-R6000HF	3000	3
/	B-499	<b>F A</b>	-	-	12.70	-	-	B33-603-499YL	BBP33	B30-R6000HF	3000	3
/	B-499	<b>F A</b>	-	-	12.70	-	-	BPT-603-499	BBP12, BP-PR+	R7950	3000	3
/	B-499	<b>F A</b>	-	-	12.70	-	-	BPT-603-499YL	BBP12, BP-PR+	R7950	3000	3
/	B-461	<b>F A H S L</b>	-	-	15.24	-	-	B33-604-461AW**	BBP33	B30-R4300	3000	3
✦	B-461	<b>F A H S L</b>	-	-	15.24	-	-	BPT-604-461AW**	BBP12, BP-PR+	R7950	3000	3

\*\*AW = All White / no transparent area.

>>



# Vial Top Labels

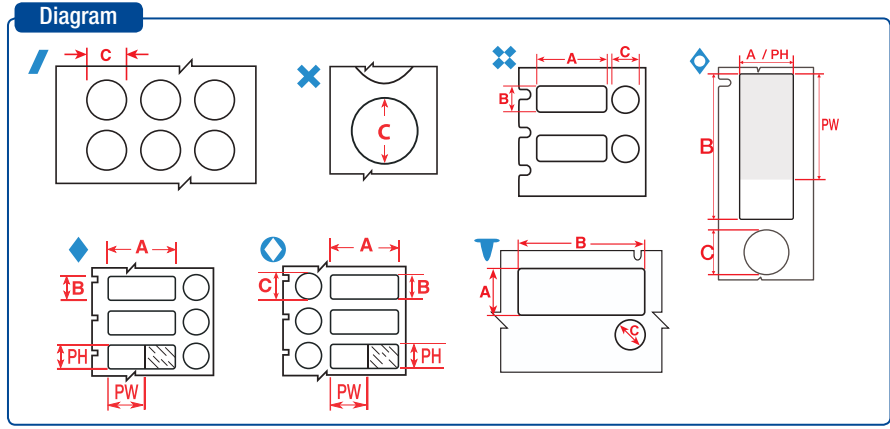

Diagram	Material	Special Properties	Label Width A (mm)	Label Height B (mm)	Diameter C (mm)	Printable Area Width PW (mm)	Printable Area Height PH (mm)	Order Reference	Printer Compatibility	Printer Ribbon Series	Labels per Roll	Labels per Row
<b>1.0 - 2.0 ml</b>												
◇	B-461	F A H S L	15.24	41.28	12.70	15.24	30.00	M71-116-461	BMP71	M71-R6200	150	1
✕	B-499	F A	25.40	9.53	9.53	-	-	B33-163-499	BBP33	B30-R6000HF	1500	1
✕	B-492	F H L	25.40	9.53	9.53	-	-	B33-163-492	BBP33	B30-R6400	1500	1
✕	B-499	F A	25.40	9.53	9.53	-	-	M-118-499	BMP51, BMP53	-	240	1
✕	B-492	F H L	25.40	9.53	9.53	-	-	M-118-492	BMP51, BMP53	-	240	1
✕	B-499	F A	25.40	9.53	9.53	-	-	THT-163-499-3	BBP12, BP-PR+, IP, i7100, i5100	R4900	3000	1
✕	B-492	F H L	25.40	9.53	9.53	-	-	THT-163-492-3	BBP12, BP-PR+, IP, i7100, i5100	R6400	3000	1
✕	B-492	F H L	25.40	12.70	9.53	-	-	M71-118-492	BMP71	M71-R6400	500	1
✕	B-492	F H L	25.40	12.70	9.53	-	-	THT-181-492-3	BP-PR+, IP, i7100, i5100	R6400	3000	1
✕	B-492	F H L	25.40	12.70	11.18	-	-	B33-182-492	BBP33	B30-R6400	1500	1
✕	B-492	F H L	25.40	12.70	11.18	-	-	THT-182-492-3	BBP12, BP-PR+, IP, i7100, i5100	R6400	3000	1
◇	B-461	F A H S L	40.00	15.00	9.00	30.00	15.00	BPTLAB-20-461-2.5	BBP12, BP-PR+	R7950	2500	1
◇	B-461	F A H S L	40.00	15.00	9.53	30.00	15.00	M71-101-461	BMP71	M71-R6200	250	1
◇	B-461	F A H S L	41.28	15.24	12.70	30.00	15.24	B33-608-461	BBP33	B30-R4300	1000	1
◇	B-461	F A H S L	41.28	15.24	12.70	30.00	15.24	BPT-608-461	BBP12, BP-PR+	R7950	1000	1
✕	B-499	F A	41.28	15.24	12.70	-	-	BPT-608-499	BBP12, BP-PR+	R7950	1000	1
/	B-499	F A	-	-	12.70	-	-	B33-144-499	BBP33	B30-R6000HF	1500	3
/	B-492	F H L	-	-	12.70	-	-	B33-144-492	BBP33	B30-R6400	1500	3
/	B-490	F H L	-	-	12.70	-	-	B33-144-490	BBP33	B30-R4300	2500	3
✕	B-499	F A	-	-	12.70	-	-	M71-83-499	BMP71	M71-R4300	500	1
/	B-499	F A	-	-	12.70	-	-	THT-144-499-3	BBP12, BP-PR+, IP, i7100, i5100	R4900	3000	3
/	B-499	F A	-	-	12.70	-	-	THT-144-499-1.5-SC	BBP12, BP-PR+	R7950	1500	3
/	B-492	F H L	-	-	12.70	-	-	THT-144-492-3	BBP12, BP-PR+, IP, i7100, i5100	R6400	3000	3
/	B-492	F H L	-	-	12.70	-	-	THT-144-492-1.5-SC	BBP12, BP-PR+	R6400	1500	3
<b>1.0 - 8.0 ml</b>												
✕	B-499	F A	22.86	12.70	12.70	-	-	B33-126-499	BBP33	B30-R6000HF	1500	1
✕	B-490	F H L	22.86	12.70	12.70	-	-	B33-126-490	BBP33	B30-R4300	2500	1
✕	B-499	F A	22.86	12.70	12.70	-	-	M71-126-499	BMP71	M71-R4300	500	1
✕	B-499	F A	22.86	12.70	12.70	-	-	THT-126-499-3	BP-PR+, IP, i7100, i5100	R4900	3000	1
✕	B-492	F H L	41.28	15.24	9.53	-	-	B33-190-492	BBP33	R6400	1500	1
✕	B-492	F H L	41.28	15.24	9.53	-	-	THT-190-492-3	BBP12, BP-PR+, IP, i7100, i5100	R6400	3000	1
<b>1.5 - 2.0 ml</b>												
✕	B-499	F A	25.40	12.70	9.53	-	-	M-120-499	BMP51, BMP53	-	240	1
✕	B-492	F H L	25.40	12.70	9.53	-	-	M-120-492	BMP51, BMP53	-	240	1
✕	B-499	F A	25.40	12.70	11.18	-	-	M-117-499	BMP51, BMP53	-	240	1
✕	B-492	F H L	25.40	12.70	11.18	-	-	M-117-492	BMP51, BMP53	-	240	1
▽	B-492	F H L	41.28	15.24	9.53	-	-	M-95-492	BMP51, BMP53	-	200	1
✕	B-499	F A	-	-	12.70	-	-	M-83-499	BMP51, BMP53	-	240	1
✕	B-499	F A	-	-	12.70	-	-	M-83-499-OR-BK	BMP51, BMP53	-	240	1
✕	B-499	F A	-	-	12.70	-	-	M-83-499-RD-BK	BMP51, BMP53	-	240	1
✕	B-499	F A	-	-	12.70	-	-	M-83-499-YL-BK	BMP51, BMP53	-	240	1
✕	B-492	F H L	-	-	12.70	-	-	M-83-492	BMP51, BMP53	-	240	1

F Freezer environment    A Autoclave environment    H Hot water bath (100°C)    S Self-laminating label    L Low-profile (extremely thin) label    R Removable

# Centrifuge / Microcentrifuge Labels

- F** Freezer environment
- N** Liquid nitrogen environment
- A** Autoclave environment
- H** Hot water bath (100°C)
- S** Self-laminating label
- L** Low-profile (extremely thin) label
- R** Removable

## CENTRIFUGE / MICROCENTRIFUGE LABELS

Brady offers a wide range of Centrifuge, Eppendorf and PCR Labels. When applying a self-laminating label, we recommend you avoid touching the adhesive side of the label when wrapping it around a vial or tube, to ensure maximum adhesion.



### Diagram

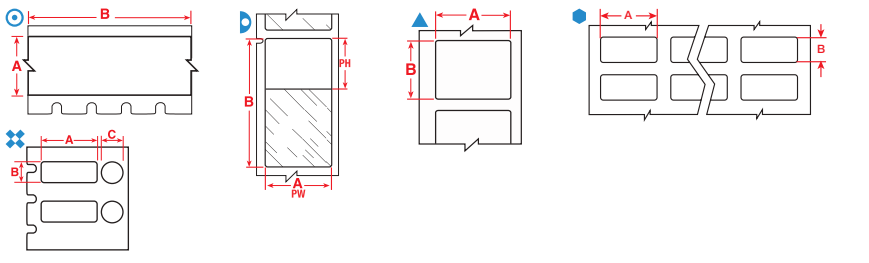

Labels are shown per vial / tube size and in order of label width.

The background colours in the Order Reference column represent the material colour.

See page 42 for Brady's range of label printers.

Diagram	Material	Special Properties	Label Width A (mm)	Label Height B (mm)	Label Length B (m)	Diameter C (mm)	Printable Area Width PW (mm)	Printable Area Height PH (mm)	Order Reference	Printer Compatibility	Printer Ribbon Series	Labels per Roll	Labels per Row
<b>0.2 ml</b>													
▶	B-461	<b>FNAHSL</b>	4.75	38.10	-	-	4.75	17.78	PTL-108-461	BMP61, BMP71	R4310	750	1
<b>0.5 ml</b>													
▶	B-461	<b>FNAHSL</b>	6.35	27.94	-	-	6.35	22.00	B33-627-461*	BBP33	B30-R4300	1000	1
▶	B-461	<b>FNAHSL</b>	6.35	27.94	-	-	6.35	22.00	BPT-627-461*	BBP12	R7950	1000	1
⊙	B-423	<b>F AH</b>	6.35	-	6.40	-	-	-	M21-250-423	BMP21-LAB	-	1	1
▶	B-427	<b>FN S</b>	25.40	63.50	-	-	25.40	19.05	PTL-21-427	BMP61, BMP71	R4310	100	1
<b>0.5 - 0.7 ml</b>													
▶	B-461	<b>FNAHSL</b>	5.08	22.86	-	-	5.08	18.00	BPT-614-461*	BBP12	R7950	2000	1
▶	B-461	<b>FNAHSL</b>	5.08	22.86	-	-	5.08	18.23	B33-614-461*	BBP33	B30-R4300	2000	1
▶	B-461	<b>FNAHSL</b>	9.53	19.05	-	-	9.53	19.05	B33-123-461*	BBP33	B30-R4300	1500	1
▶	B-461	<b>FNAHSL</b>	9.53	19.05	-	-	9.53	19.05	THT-123-461-1.5-SC*	BBP12, BP-PR+	R7950	1500	1
▲	B-499	<b>FNA</b>	9.53	25.40	-	-	-	-	M71-16-499	BMP71	M71-R4300	500	1
▲	B-498	<b>F</b>	<b>R</b>	9.53	25.40	-	-	-	M71-16-498	BMP71	M71-R6200	500	1
▲	B-499	<b>FNA</b>	9.53	25.40	-	-	-	-	PTL-16-499	BMP61, BMP71	R4310	500	1
▲	B-498	<b>F</b>	<b>R</b>	9.53	25.40	-	-	-	PTL-16-498	BMP61, BMP71	R6210	500	1
▶	B-461	<b>FNAHSL</b>	9.53	28.58	-	-	9.53	19.05	M-123-461	BMP51, BMP53	-	360	1
▶	B-461	<b>FNAHSL</b>	9.53	45.72	-	-	9.53	19.05	M71-73-461	BMP71	M71-R6200	250	1
▶	B-461	<b>FNAHSL</b>	9.53	45.72	-	-	9.53	19.05	PTL-73-461	BMP61, BMP71	R4310	500	1
▶	B-461	<b>FNAHSL</b>	9.53	45.72	-	-	9.53	19.05	THT-123-461-3*	BBP12, BP-PR+, IP, i7100, i5100	R4300, R7950	3000	1
●	B-499	<b>FNA</b>	12.70	19.05	-	-	-	-	B33-68-499	BBP33	B30-R6000HF	1500	4
●	B-490	<b>FN H L</b>	12.70	19.05	-	-	-	-	B33-68-490	BBP33	B30-R4300	2500	4
▲	B-499	<b>FNA</b>	12.70	19.05	-	-	-	-	PTL-11-499	BMP61, BMP71	R4310	500	1
▲	B-498	<b>F</b>	<b>R</b>	12.70	19.05	-	-	-	PTL-11-498	BMP61, BMP71	R6210	500	1
●	B-499	<b>FNA</b>	12.70	19.05	-	-	-	-	THT-68-499-10	BBP12, BP-PR+, IP, i7100, i5100	R4900	10000	4
▶	B-461	<b>FNAHSL</b>	12.70	28.58	-	-	12.70	19.05	M-122-461	BMP51, BMP53	-	360	1
▶	B-461	<b>FNAHSL</b>	12.70	44.45	-	-	12.70	19.05	M-72-461	BMP51, BMP53	-	180	1
▶	B-461	<b>FNAHSL</b>	12.70	45.72	-	-	12.70	19.05	B33-122-461*	BBP33	B30-R4300	1500	1
▶	B-461	<b>FNAHSL</b>	12.70	45.72	-	-	12.70	19.05	PTL-72-461	BMP61, BMP71	R4310	500	1
▶	B-461	<b>FNAHSL</b>	12.70	45.72	-	-	12.70	19.05	THT-122-461-3*	BBP12, BP-PR+, IP, i7100, i5100	R4300, R7950	3000	1
▶	B-461	<b>FNAHSL</b>	12.70	45.72	-	-	12.70	19.05	THT-122-461-1.5-SC*	BBP12, BP-PR+	R7950	1500	1
▶	B-461	<b>FNAHSL</b>	12.70	55.88	-	-	12.70	19.05	B33-127-461	BBP33	B30-R4300	1500	3
▶	B-461	<b>FNAHSL</b>	12.70	55.88	-	-	12.70	19.05	THT-127-461-3*	BBP12, BP-PR+, IP, i7100, i5100	R4300, R7950	3000	1
▶	B-461	<b>FNAHSL</b>	12.70	55.88	-	-	12.70	19.05	THT-127-461-1.5-SC*	BBP12, BP-PR+	R7950	1500	1
▶	B-427	<b>FN S</b>	12.70	55.88	-	-	12.70	19.05	THT-127-427-3*	BBP12, BP-PR+, IP, i7100, i5100	R4300, R7950	3000	1
▲	B-499	<b>FNA</b>	19.05	12.70	-	-	-	-	BM71-11-499	BMP61, BMP71	R4310	5000	1

\*Label is rotated 90° on liner.

>>

**i** These labels are also suitable for Eppendorf tubes and PCR process.

# Centrifuge / Microcentrifuge Labels

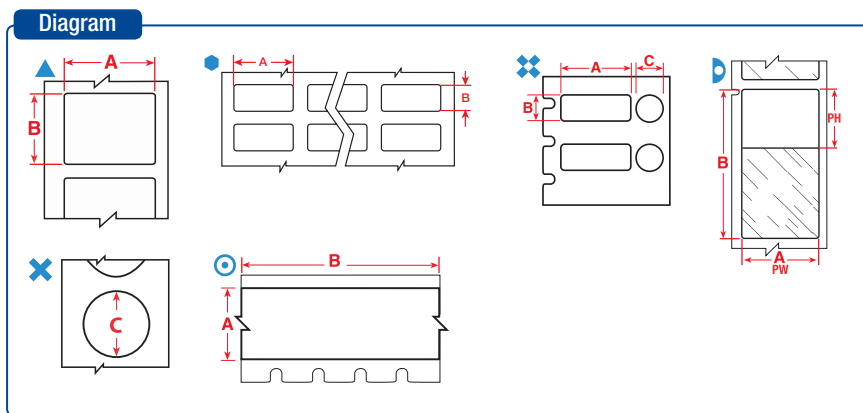

Labels are shown per vial / tube size and in order of label width.

The background colours in the Order Reference column represent the material colour.

See page 42 for Brady's range of label printers.

Diagram	Material	Special Properties	Label Width A (mm)	Label Height B (mm)	Label Length B (m)	Diameter C (mm)	Printable Area Width PW (mm)	Printable Area Height PH (mm)	Order Reference	Printer Compatibility	Printer Ribbon Series	Labels per Roll	Labels per Row
<b>0.5 - 0.7 ml</b>													
▲	B-498	<b>F</b>	19.05	12.70	-	-	-	-	BM71-11-498	BMP61, BMP71	R6200	5000	1
▲	B-499	<b>FNA</b>	19.05	12.70	-	-	-	-	M-11-499	BMP51, BMP53	-	220	1
▲	B-499	<b>FNA</b>	19.05	12.70	-	-	-	-	M71-11-499	BMP71	M71-R4300	500	1
▲	B-498	<b>F</b>	19.05	12.70	-	-	-	-	M71-11-498	BMP71	M71-R6200	500	1
⬢	B-499	<b>FNA</b>	25.40	9.53	-	-	-	-	B33-152-499	BBP33	B30-R6000HF	1500	2
⬢	B-492	<b>FNHL</b>	25.40	9.53	-	-	-	-	B33-152-492	BBP33	B30-R6400	2500	2
⊗	B-499	<b>FA</b>	25.40	9.53	-	9.53	-	-	M71-98-499	BMP71	M71-R4300	500	1
▲	B-492	<b>FNHL</b>	25.40	9.53	-	-	-	-	M71-16-492	BMP71	M71-R6400	500	1
⬢	B-499	<b>FNA</b>	25.40	9.53	-	-	-	-	THT-152-499-3	BBP12, BP-PR+, IP, i7100, i5100	R4900	3000	2
⬢	B-499	<b>FNA</b>	25.40	9.53	-	-	-	-	THT-152-499-1.5-SC	BBP12, BP-PR+	R7950	1500	2
⬢	B-492	<b>FNHL</b>	25.40	9.53	-	-	-	-	THT-152-492-3	BBP12, BP-PR+, IP, i7100, i5100	R6400	3000	2
▲	B-492	<b>FNHL</b>	25.40	9.53	-	-	-	-	THT-152-492-2.5-SC	BBP12, BP-PR+	R6400	2500	2
⬢	B-425	<b>F</b>	25.40	9.98	-	-	-	-	THT-30-425-10	BBP12, BP-PR+, IP, i7100, i5100	R6400	10000	3
▲	B-490	<b>FNHL</b>	31.75	9.53	-	-	-	-	B33-154-490	BBP33	B30-R4300	1500	1
▲	B-492	<b>FNHL</b>	31.75	9.53	-	-	-	-	M-112-492	BMP51, BMP53	-	360	1
▲	B-490	<b>FNHL</b>	31.75	9.53	-	-	-	-	M-112-490	BMP51, BMP53	-	360	1
▲	B-490	<b>FNHL</b>	31.75	9.53	-	-	-	-	PTL-112-490	BMP61, BMP71	R4310	500	1
▲	B-490	<b>FNHL</b>	31.75	9.53	-	-	-	-	THT-154-490-3	BBP12, BP-PR+, IP, i7100, i5100	R4300	3000	1
▲	B-490	<b>FNHL</b>	31.75	9.53	-	-	-	-	THT-154-490-1.5-SC	BBP12, BP-PR+	R7950	1500	1
<b>0.5 - 1.5 ml</b>													
⊗	B-492	<b>FHL</b>	-	-	-	9.53	-	-	M-82-492	BMP51, BMP53	-	240	1
⊗	B-499	<b>FA</b>	-	-	-	9.53	-	-	M-82-499-RD-BK	BMP51, BMP53	-	240	1
<b>0.5 - 2.0 ml</b>													
▷	B-427	<b>FNS</b>	12.70	55.88	-	-	12.70	19.05	PTL-74-427	BMP61, BMP71	R4310	100	1
▷	B-461	<b>FNAHSL</b>	12.70	55.88	-	-	12.70	19.05	PTL-74-461	BMP61, BMP71	R4310	100	1
<b>0.6 ml</b>													
▲	B-492	<b>FNHL</b>	9.53	20.96	-	-	-	-	M-130-492	BMP51, BMP53	-	220	1
▲	B-499	<b>FNA</b>	9.53	20.96	-	-	-	-	M-130-499	BMP51, BMP53	-	220	1
⊙	B-499	<b>FNA</b>	9.53	-	4.88	-	-	-	M21-375-499	BMP21-LAB	-	1	1
⊙	B-499	<b>FNA</b>	9.53	-	4.88	-	-	-	MC-375-499	BMP51, BMP53	-	1	1
⊙	B-461	<b>FNAHSL</b>	9.53	-	6.40	-	9.53	-	M21-375-461-AW**	BMP21-LAB	-	1	1
▲	B-499	<b>FNA</b>	22.86	12.70	-	-	-	-	M71-84-499	BMP71	M71-R4300	500	1
▲	B-499	<b>FNA</b>	22.86	12.70	-	-	-	-	M-84-499	BMP51, BMP53	-	200	1
▲	B-492	<b>FNHL</b>	31.75	6.35	-	-	-	-	M-155-492	BMP51, BMP53	-	180	1
<b>0.6 - 1.5 ml</b>													
⊗	B-499	<b>FA</b>	25.40	9.53	-	9.53	-	-	PTL-98-499	BMP61, BMP71	R4310	500	1

\*Label is rotated 90° on liner.

\*\*AW = All White / no transparent area.

>>

**i** These labels are also suitable for Eppendorf tubes and PCR process.

**F** Freezer environment **N** Liquid nitrogen environment **A** Autoclave environment **H** Hot water bath (100°C) **S** Self-laminating label **L** Low-profile (extremely thin) label **R** Removable

# Centrifuge / Microcentrifuge Labels

## Diagram

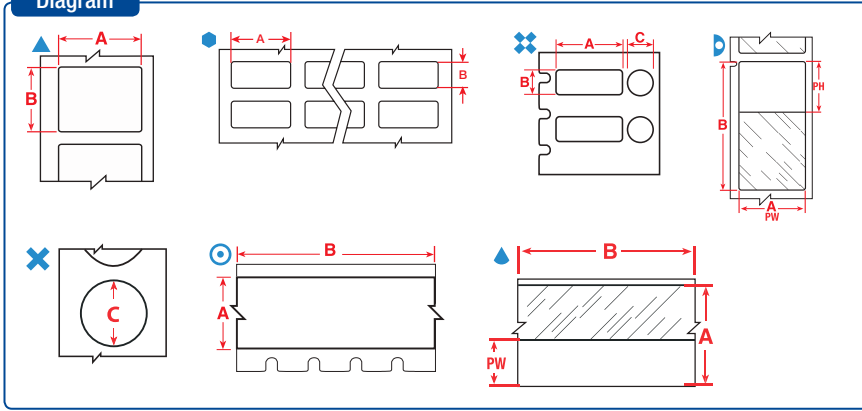

The background colours in the Order Reference column represent the material colour.

See page 42 for Brady's range of label printers.

Labels are shown per vial / tube size and in order of label width.

Diagram	Material	Special Properties	Label Width A (mm)	Label Height B (mm)	Label Length B (mm)	Diameter C (mm)	Printable Area Width PW (mm)	Printable Area Height PH (mm)	Order Reference	Printer Compatibility	Printer Ribbon Series	Labels per Roll	Labels per Row
<b>1.0 - 2.0 ml</b>													
❖	B-492	<b>F H L</b>	25.40	9.53	-	9.53	-	-	M-118-492	BMP51, BMP53	-	240	1
❖	B-499	<b>F A</b>	25.40	9.53	-	9.53	-	-	M-118-499	BMP51, BMP53	-	240	1
<b>1.0 - 8.0 ml</b>													
▲	B-490	<b>F N H L</b>	41.28	15.24	-	-	-	-	PTL-76-490	BMP61, BMP71	R4310	250	1
▲	B-492	<b>F N H L</b>	12.70	25.40	-	-	-	-	M-131-492	BMP51, BMP53	-	180	1
▲	B-499	<b>F N A</b>	12.70	25.40	-	-	-	-	M-131-499	BMP51, BMP53	-	180	1
▷	B-461	<b>F N A H S L</b>	12.70	55.88	-	-	12.70	19.05	M-74-461	BMP51, BMP53	-	140	1
▷	B-461	<b>F N A H S L</b>	15.24	41.28	-	-	15.24	25.40	M71-76-461	BMP71	M71-R6200	500	1
▷	B-461	<b>F N A H S L</b>	15.24	41.28	-	-	15.24	25.40	PTL-76-461	BMP61, BMP71	R4310	250	1
▷	B-461	<b>F N A H S L</b>	15.24	45.72	-	-	15.24	25.40	M-126-461	BMP51, BMP53	-	180	1
▲	B-490	<b>F N H L</b>	15.24	45.72	-	-	-	-	M-126-490	BMP51, BMP53	-	180	1
▷	B-461	<b>F N A H S L</b>	15.24	66.68	-	-	15.24	25.40	B33-153-461*	BBP33	B30-R4300	1500	1
▷	B-461	<b>F N A H S L</b>	15.24	66.68	-	-	15.24	25.40	M71-86-461	BMP71	M71-R6200	100	1
▷	B-461	<b>F N A H S L</b>	15.24	66.68	-	-	15.24	25.40	M-86-461	BMP51, BMP53	-	120	1
▷	B-461	<b>F N A H S L</b>	15.24	66.68	-	-	15.24	25.40	PTL-86-461	BMP61, BMP71	R4310	100	1
❖	B-499	<b>F A</b>	22.86	12.70	-	12.70	-	-	M71-126-499	BMP71	M71-R4300	500	1
❖	B-499	<b>F A</b>	22.86	12.70	-	12.70	-	-	PTL-117-499	BMP61, BMP71	R4310	500	1
❖	B-499	<b>F A</b>	22.86	12.70	-	12.70	-	-	THT-126-499-3	BP-PR+, IP, i7100, i5100	R4900	3000	1
▲	B-490	<b>F N H L</b>	41.28	15.24	-	-	-	-	B33-155-490	BBP33	B30-R4300	1500	1
▲	B-492	<b>F N H L</b>	41.28	15.24	-	-	-	-	B33-155-492	BBP33	R6400	1500	1
▲	B-490	<b>F N H L</b>	41.28	15.24	-	-	-	-	M71-76-490	BMP71	M71-R4300	500	1
▲	B-490	<b>F N H L</b>	41.28	15.24	-	-	-	-	THT-155-490-1.5-SC	BBP12, BP-PR+	R7950	1500	1
▲	B-490	<b>F N H L</b>	41.28	15.24	-	-	-	-	THT-155-490-3	BBP12, BP-PR+, IP, i7100, i5100	R4300, R7950	3000	1
▲	B-492	<b>F N H L</b>	41.28	15.24	-	-	-	-	THT-155-492-3	BBP12, BP-PR+, IP, i7100, i5100	R6400	3000	1
<b>1.5 ml</b>													
⊙	B-499	<b>F N A</b>	12.70	-	4.88	-	-	-	M21-500-499	BMP21-LAB	-	1	1
⊙	B-499	<b>F N A</b>	12.70	-	4.88	-	-	-	MC-500-499	BMP51, BMP53	-	1	1
⊙	B-461	<b>F N A H S L</b>	12.70	-	6.40	-	12.70	-	M21-500-461-AW**	BMP21-LAB	-	1	1
⊙	B-461	<b>F N A H S L</b>	12.70	-	7.62	-	12.70	-	MC-500-461-AW**	BMP51, BMP53	-	1	1
⊙	B-492	<b>F N H L</b>	12.70	-	7.62	-	-	-	MC-500-492	BMP51, BMP53	-	1	1
⊙	B-499	<b>F N A</b>	12.70	-	9.10	-	-	-	M71C-500-499	BMP71	M71-R4300	1	1

\*Label is rotated 90° on liner.

\*\*AW = All White / no transparent area.

**i** These labels are also suitable for Eppendorf tubes and PCR process.

**F** Freezer environment **N** Liquid nitrogen environment **A** Autoclave environment **H** Hot water bath (100°C) **S** Self-laminating label **L** Low-profile (extremely thin) label **R** Removable

# Centrifuge / Microcentrifuge Labels

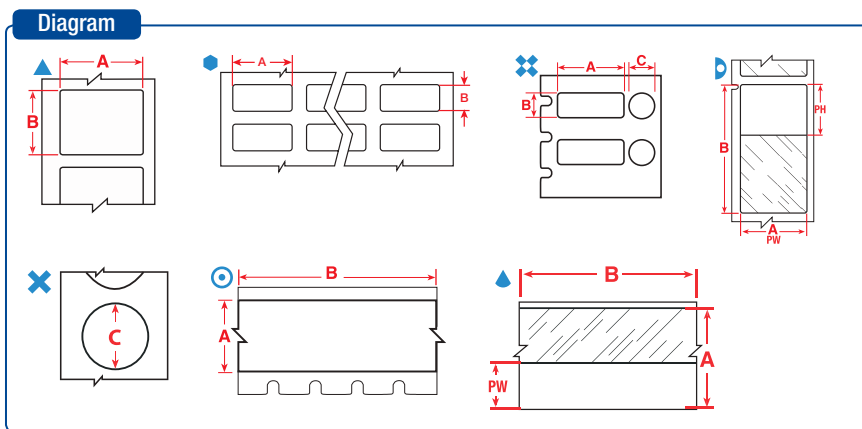

The background colours in the Order Reference column represent the material colour.

See page 42 for Brady's range of label printers.

Labels are shown per vial / tube size and in order of label width.

Diagram	Material	Special Properties	Label Width A (mm)	Label Height B (mm)	Label Length B (mm)	Diameter C (mm)	Printable Area Width PW (mm)	Printable Area Height PH (mm)	Order Reference	Printer Compatibility	Printer Ribbon Series	Labels per Roll	Labels per Row
<b>1.5 - 2.0 ml</b>													
▶	B-461	<b>FNAHSL</b>	12.70	41.91	-	-	12.70	19.05	M-124-461	BMP51, BMP53	-	180	1
▲	B-490	<b>FNHL</b>	12.70	41.91	-	-	-	-	M-124-490	BMP51, BMP53	-	180	1
▶	B-461	<b>FNAHSL</b>	15.24	41.28	-	-	15.24	25.40	THT-133-461-1.5-SC*	BBP12, BP-PR+	R7950	1500	1
▶	B-461	<b>FNAHSL</b>	15.24	41.28	-	-	15.24	25.40	THT-133-461-3*	BBP12, BP-PR+, IP, i7100, i5100	R4300, R7950	3000	1
▶	B-461	<b>FNAHSL</b>	15.24	66.68	-	-	15.24	25.40	THT-153-461-1.5-SC*	BBP12, BP-PR+	R7950	1500	1
▶	B-461	<b>FNAHSL</b>	15.24	66.68	-	-	15.24	25.40	THT-153-461-3*	BBP12, BP-PR+, IP, i7100, i5100	R4300, R7950	3000	1
⊗	B-492	<b>FHL</b>	25.40	12.70	-	9.53	-	-	M-120-492	BMP51, BMP53	-	240	1
⊗	B-499	<b>FA</b>	25.40	12.70	-	9.53	-	-	M-120-499	BMP51, BMP53	-	240	1
⊗	B-492	<b>FHL</b>	25.40	12.70	-	11.18	-	-	M-117-492	BMP51, BMP53	-	240	1
⊗	B-499	<b>FA</b>	25.40	12.70	-	11.18	-	-	M-117-499	BMP51, BMP53	-	240	1
▲	B-492	<b>FNHL</b>	25.40	12.70	-	-	-	-	B33-59-492	BBP33	B30-R6400	2500	1
▲	B-492	<b>FNHL</b>	25.40	12.70	-	-	-	-	THT-59-492-10	BBP12, BP-PR+, IP, i7100, i5100	R6400	10000	1
▲	B-492	<b>FNHL</b>	25.40	12.70	-	-	-	-	THT-59-492-2.5-SC	BBP12, BP-PR+	R6400	2500	1
▲	B-492	<b>FNHL</b>	41.91	12.70	-	-	-	-	M-124-492	BMP51, BMP53	-	180	1
▲	B-492	<b>FHL</b>	-	-	-	12.70	-	-	M-83-492	BMP51, BMP53	-	240	1
⊗	B-499	<b>FA</b>	-	-	-	12.70	-	-	M-83-499-OR-BK	BMP51, BMP53	-	240	1
⊗	B-499	<b>FA</b>	-	-	-	12.70	-	-	M-83-499-RD-BK	BMP51, BMP53	-	240	1
<b>2.0 - 50.0 ml</b>													
▲	B-427	<b>FN S</b>	19.05	-	4.30	-	9.53	-	M21-750-427	BMP21-LAB	-	1	-
⊙	B-499	<b>FNA</b>	19.05	-	4.88	-	-	-	M21-750-499	BMP21-LAB	-	1	1
⊙	B-499	<b>FNA</b>	19.05	-	4.88	-	-	-	MC-750-499	BMP51, BMP53	-	1	1
⊙	B-461	<b>FNAHSL</b>	19.05	-	6.40	-	19.05	-	M21-750-461-AW**	BMP21-LAB	-	1	1
▲	B-427	<b>FN S</b>	19.05	-	7.62	-	9.53	-	MC-750-427	BMP51, BMP53	-	1	1
⊙	B-499	<b>FNA</b>	25.40	-	4.88	-	-	-	MC-1000-499	BMP51, BMP53	-	1	1
⊙	B-499	<b>FNA</b>	25.40	-	9.10	-	-	-	M71C-1000-499	BMP71	M71-R4300	1	1
<b>5.0 - 50.0 ml</b>													
⊙	B-499	<b>FNA</b>	48.26	-	9.10	-	-	-	M71C-1900-499	BMP71	M71-R4300	1	1

\*Label is rotated 90° on liner.

\*\*AW = All White / no transparent area.

**i** These labels are also suitable for Eppendorf tubes and PCR process.

**F** Freezer environment **N** Liquid nitrogen environment **A** Autoclave environment **H** Hot water bath (100°C) **S** Self-laminating label **L** Low-profile (extremely thin) label **R** Removable



## CRYO TUBES & VIALS

Brady's offers a range of labels designed specifically to identify laboratory samples for cryo storage. These labels can be applied to room temperature or to already frozen samples, albeit with a small overlap. The label will remain legible and will stick to the sample container during processing, even when exposed to extreme heat or chemicals like DMSO, Xylene and Ethanol, ensuring secure sample identification in the most challenging laboratory conditions.

- F** Freezer environment
- N** Liquid nitrogen environment
- A** Autoclave environment
- H** Hot water bath (100°C)
- S** Self-laminating label
- L** Low-profile (extremely thin) label
- R** Removable

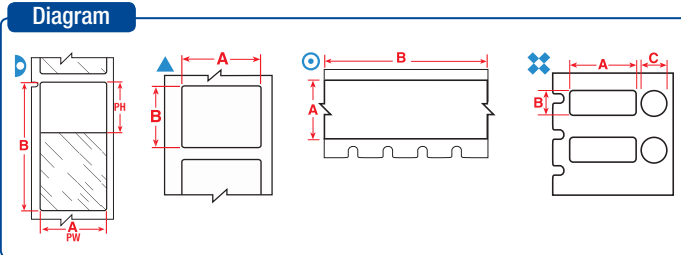
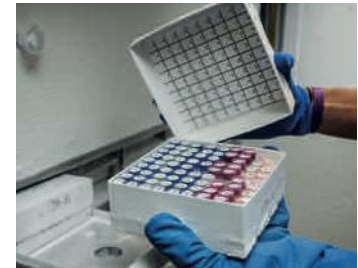
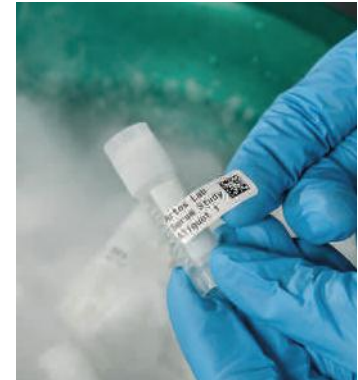

The background colours in the Order Reference column represent the material colour.

See page 42 for Brady's range of label printers.

Labels are shown per vial / tube size and in order of label width.

Diagram	Material	Special Properties	Label Width A (mm)	Label Height B (mm)	Label Length B (m)	Printable Area Width PW (mm)	Printable Area Height PH (mm)	Order Reference	Printer Compatibility	Printer Ribbon Series	Labels per Roll	Labels per Row
<b>0.5 - 0.7 ml</b>												
▶	B-461	<b>FNAHSL</b>	9.53	28.58	–	9.53	19.05	M-123-461	BMP51, BMP53	–	360	1
▲	B-499	<b>FNA</b>	12.70	19.05	–	–	–	PTL-11-499	BMP61, BMP71	R4310	500	1
▶	B-461	<b>FNAHSL</b>	12.70	28.58	–	12.70	19.05	M-122-461	BMP51, BMP53	–	360	1
▶	B-461	<b>FNAHSL</b>	12.70	44.45	–	12.70	19.05	M-72-461	BMP51, BMP53	–	180	1
▲	B-499	<b>FNA</b>	19.05	12.70	–	–	–	BM71-11-499	BMP61, BMP71	R4310	5000	1
▲	B-499	<b>FNA</b>	19.05	12.70	–	–	–	M-11-499	BMP51, BMP53	–	220	1
▲	B-499	<b>FNA</b>	19.05	12.70	–	–	–	M71-11-499	BMP71	M71-R4300	500	1
▲	B-490	<b>FNHL</b>	31.75	9.53	–	–	–	M-112-490	BMP51, BMP53	–	360	1
<b>0.5 - 2.0 ml</b>												
▶	B-461	<b>FNAHSL</b>	12.70	55.88	–	12.70	19.05	PTL-74-461	BMP61, BMP71	R4310	100	1
▶	B-427	<b>FN S</b>	12.70	55.88	–	12.70	19.05	PTL-74-427	BMP61, BMP71	R4310	100	1
<b>0.6 ml</b>												
▲	B-499	<b>FNA</b>	9.53	20.96	–	–	–	M-130-499	BMP51, BMP53	–	220	1
▲	B-492	<b>FNHL</b>	9.53	20.96	–	–	–	M-130-492	BMP51, BMP53	–	220	1
◎	B-499	<b>FNA</b>	9.53	–	4.88	–	–	M21-375-499	BMP21-LAB	–	1	1
◎	B-499	<b>FNA</b>	9.53	–	4.88	–	–	MC-375-499	BMP51, BMP53	–	1	1
◎	B-461	<b>FNAHSL</b>	9.53	–	6.40	9.53	–	M21-375-461-AW**	BMP21-LAB	–	1	1
◎	B-461	<b>FNAHSL</b>	9.53	–	7.62	9.53	–	MC-375-461-AW**	BMP51, BMP53	–	1	1
▲	B-499	<b>FNA</b>	22.86	12.70	–	–	–	M-84-499	BMP51, BMP53	–	200	1
<b>0.6 - 1.5 ml</b>												
❖	B-499	<b>FA</b>	25.40	9.53	–	–	–	PTL-98-499	BMP61, BMP71	R4310	500	1

\*\*AW = All White / no transparent area.

>>

### Part number explanation

Most Brady references for printable labels follow the same three-part format: The first code indicates the technology, the second part is a number indicating the label size (where applicable) and the third part indicates the Brady material (where applicable).

## M71-73-461

BMP71  
Technology

Label size  
code

Material  
(B-number)

# Cryo Tubes & Vials

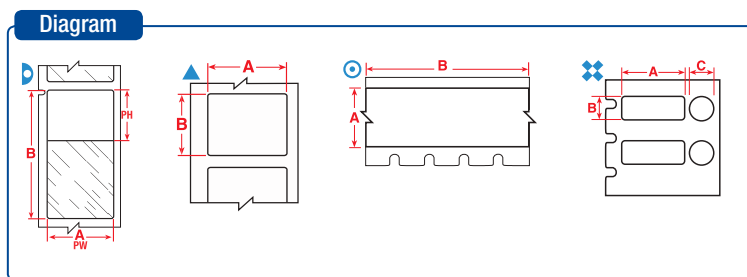

The background colours in the Order Reference column represent the material colour.

See page 42 for Brady's range of label printers.

Labels are shown per vial / tube size and in order of label width.

Diagram	Material	Special Properties	Label Width A (mm)	Label Height B (mm)	Label Length B (m)	Printable Area Width PW (mm)	Printable Area Height PH (mm)	Order Reference	Printer Compatibility	Printer Ribbon Series	Labels per Roll	Labels per Row
<b>1.0 - 8.0 ml</b>												
▲	B-499	<b>FNA</b>	12.70	25.40	-	-	-	M-131-499	BMP51, BMP53	-	180	1
▲	B-492	<b>FNHL</b>	12.70	25.40	-	-	-	M-131-492	BMP51, BMP53	-	180	1
▷	B-461	<b>FNAHSL</b>	12.70	55.88	-	12.70	19.05	M-74-461	BMP51, BMP53	-	140	1
▷	B-461	<b>FNAHSL</b>	15.24	41.28	-	15.24	25.40	PTL-76-461	BMP61, BMP71	R4310	250	1
▷	B-461	<b>FNAHSL</b>	15.24	45.72	-	15.24	25.40	M-126-461	BMP51, BMP53	-	180	1
▲	B-490	<b>FNHL</b>	15.24	45.72	-	-	-	M-126-490	BMP51, BMP53	-	180	1
▷	B-461	<b>FNAHSL</b>	15.24	66.68	-	15.24	25.40	M-86-461	BMP51, BMP53	-	120	1
▷	B-461	<b>FNAHSL</b>	15.24	66.68	-	15.24	25.40	PTL-86-461	BMP61, BMP71	R4310	100	1
✘	B-499	<b>FA</b>	22.86	12.70	-	-	-	PTL-117-499	BMP61, BMP71	R4310	500	1
▷	B-461	<b>FNAHSL</b>	25.40	44.45	-	25.40	25.40	M-125-461	BMP51, BMP53	-	180	1
▲	B-490	<b>FNHL</b>	25.40	44.45	-	-	-	M-125-490	BMP51, BMP53	-	180	1
▷	B-461	<b>FNAHSL</b>	25.40	66.68	-	25.40	25.40	BM71-75-461	BMP61, BMP71	R6200	1000	1
▷	B-461	<b>FNAHSL</b>	25.40	66.68	-	25.40	25.40	M-75-461	BMP51, BMP53	-	120	1
▷	B-461	<b>FNAHSL</b>	25.40	66.68	-	25.40	25.40	PTL-75-461	BMP61, BMP71	R4310	100	1
▷	B-461	<b>FNAHSL</b>	25.40	66.68	-	25.40	25.40	PTL-75-461-YL	BMP61, BMP71	R4310	100	1
▷	B-427	<b>FN S</b>	25.40	66.68	-	25.40	25.40	PTL-75-427	BMP61, BMP71	R4310	100	1
▲	B-490	<b>FNHL</b>	41.28	15.24	-	-	-	PTL-76-490	BMP61, BMP71	R4310	250	1
▲	B-490	<b>FNHL</b>	48.26	25.40	-	-	-	PTL-78-490	BMP61, BMP71	R4310	250	1
<b>1.0 - 15.0 ml</b>												
▲	B-492	<b>FNHL</b>	22.86	25.40	-	-	-	M-156-492	BMP51, BMP53	-	180	1
<b>1.5 ml</b>												
○	B-499	<b>FNA</b>	12.70	-	4.88	-	-	M21-500-499	BMP21-LAB	-	1	1
○	B-499	<b>FNA</b>	12.70	-	4.88	-	-	MC-500-499	BMP51, BMP53	-	1	1
○	B-461	<b>FNAHSL</b>	12.70	-	6.40	12.70	-	M21-500-461-AW**	BMP21-LAB	-	1	1
○	B-461	<b>FNAHSL</b>	12.70	-	7.62	12.70	-	MC-500-461-AW**	BMP51, BMP53	-	1	1
○	B-499	<b>FNA</b>	12.70	-	9.10	-	-	M71C-500-499	BMP71	M71-R4300	1	1
<b>2.0 - 50.0 ml</b>												
○	B-499	<b>FNA</b>	19.05	-	4.88	-	-	M21-750-499	BMP21-LAB	-	1	1
○	B-499	<b>FNA</b>	19.05	-	4.88	-	-	MC-750-499	BMP51, BMP53	-	1	1
○	B-461	<b>FNAHSL</b>	19.05	-	6.40	19.05	-	M21-750-461-AW**	BMP21-LAB	-	1	1
○	B-499	<b>FNA</b>	25.40	-	4.88	-	-	MC-1000-499	BMP51, BMP53	-	1	1
○	B-461	<b>FNAHSL</b>	25.40	-	7.62	25.40	-	MC-1000-461-AW**	BMP51, BMP53	-	1	1
○	B-499	<b>FNA</b>	25.40	-	9.10	-	-	M71C-1000-499	BMP71	M71-R4300	1	1
<b>4.0 - 50.0 ml</b>												
○	B-461	<b>FNAHSL</b>	31.75	-	7.62	31.75	-	MC-1250-461-AW**	BMP51, BMP53	-	1	1
<b>12.0 - 14.0 ml</b>												
▷	B-461	<b>FNAHSL</b>	38.10	95.25	-	38.10	31.75	M-119-461	BMP51, BMP53	-	80	1
<b>12.0 - 24.0 ml</b>												
▷	B-461	<b>FNAHSL</b>	19.05	95.25	-	19.05	25.40	PTL-79-461	BMP61, BMP71	R4310	100	1
▲	B-492	<b>FNHL</b>	25.40	48.26	-	-	-	M-78-492	BMP51, BMP53	-	100	1
▲	B-498	<b>F R</b>	38.10	12.70	-	-	-	BM71-29-498	BMP61, BMP71	R6200	5000	1
▲	B-499	<b>FNA</b>	38.10	12.70	-	-	-	M71-29-499	BMP71	M71-R4300	500	1
▲	B-498	<b>F R</b>	38.10	12.70	-	-	-	PTL-29-498	BMP61, BMP71	R6210	500	1
▲	B-499	<b>FNA</b>	38.10	31.75	-	-	-	M-132-499	BMP51, BMP53	-	160	1
▷	B-461	<b>FNAHSL</b>	38.10	88.90	-	38.10	31.75	PTL-77-461	BMP61, BMP71	R4310	100	1

\*\*AW = All White / no transparent area.

**F** Freezer environment **N** Liquid nitrogen environment **A** Autoclave environment **H** Hot water bath (100°C) **S** Self-laminating label **L** Low-profile (extremely thin) label **R** Removable

## CONICAL / LARGE TUBE LABELS

Brady offers several sample identification labels which are perfect to identify conicals. They are easy to handle, have great flexibility and easily wrap around curved sample containers. Your sample identification label will remain attached and legible, even when the sample is stored in a freezer, in liquid nitrogen or heated in an autoclave.

- F** Freezer environment
- N** Liquid nitrogen environment
- A** Autoclave environment
- H** Hot water bath (100°C)
- S** Self-laminating label
- L** Low-profile (extremely thin) label
- R** Removable

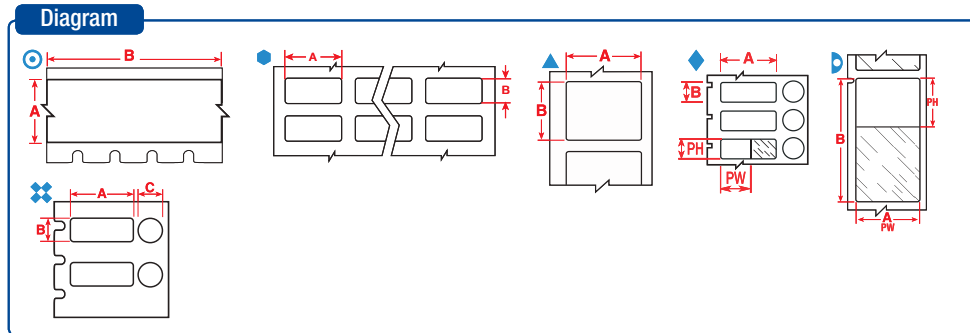

The background colours in the Order Reference column represent the material colour.

See page 42 for Brady's range of label printers.

Labels are shown per vial / tube size and in order of label width.

Diagram	Material	Special Properties	Label Width A (mm)	Label Height B (mm)	Label Length B (m)	Diameter C (mm)	Printable Area Width PW (mm)	Printable Area Height PH (mm)	Order Reference	Printer Compatibility	Printer Ribbon Series	Labels per Roll	Labels per Row
<b>0.5 ml</b>													
⊙	B-423	<b>F A H</b>	6.35	—	6.40	—	—	—	M21-250-423	BMP21-LAB	—	1	1
⊙	B-427	<b>F N S</b>	25.40	63.50	—	—	25.40	19.05	PTL-21-427	BMP61, BMP71	R4310	100	1
<b>0.5 - 0.7 ml</b>													
⬢	B-499	<b>F N A</b>	12.70	19.05	—	—	—	—	B33-68-499	BBP33	B30-R6000HF	1500	4
⬢	B-499	<b>F N A</b>	12.70	19.05	—	—	—	—	THT-68-499-10	BBP12, BP-PR+, IP, i7100, i5100	R4900	10000	4
▲	B-499	<b>F N A</b>	12.70	25.40	—	—	—	—	B33-620-499	BBP33	B30-R6000HF	1000	1
▲	B-499	<b>F N A</b>	12.70	25.40	—	—	—	—	BPT-620-499	BBP12, BP-PR+	R7950	1000	1
⊙	B-461	<b>F N A H S L</b>	12.70	55.88	—	—	12.70	19.05	B33-127-461	BBP33	B30-R4300	1500	3
⊙	B-427	<b>F N S</b>	12.70	55.88	—	—	12.70	19.05	THT-127-427-3*	BBP12, BP-PR+, IP, i7100, i5100	R4300, R7950	3000	1
⊙	B-461	<b>F N A H S L</b>	12.70	55.88	—	—	12.70	19.05	THT-127-461-1.5-SC*	BBP12, BP-PR+	R7950	1500	1
⊙	B-461	<b>F N A H S L</b>	12.70	55.88	—	—	12.70	19.05	THT-127-461-3*	BBP12, BP-PR+, IP, i7100, i5100	R4300, R7950	3000	1
▲	B-499	<b>F N A</b>	19.05	12.70	—	—	—	—	M71-11-499	BMP71	M71-R4300	500	1
◆	B-461	<b>F A H S L</b>	25.40	9.53	—	9.53	20.00	9.53	B33-606-461	BBP33	B30-R4300	1000	1
◆	B-461	<b>F A H S L</b>	25.40	9.53	—	9.53	20.00	9.53	BPT-606-461	BBP12, BP-PR+	R7950	1000	1
⊗	B-499	<b>F A</b>	25.40	9.53	—	9.53	—	—	M71-98-499	BMP71	M71-R4300	500	1
⬢	B-492	<b>F N H L</b>	25.40	9.53	—	—	—	—	B33-152-492	BBP33	B30-R6400	2500	2
⬢	B-499	<b>F N A</b>	25.40	9.53	—	—	—	—	B33-152-499	BBP33	B30-R6000HF	1500	2
▲	B-492	<b>F N H L</b>	25.40	9.53	—	—	—	—	M71-16-492	BMP71	M71-R6400	500	1
▲	B-492	<b>F N H L</b>	25.40	9.53	—	—	—	—	THT-152-492-2.5-SC	BBP12, BP-PR+	R6400	2500	2
⬢	B-492	<b>F N H L</b>	25.40	9.53	—	—	—	—	THT-152-492-3	BBP12, BP-PR+, IP, i7100, i5100	R6400	3000	2
⬢	B-499	<b>F N A</b>	25.40	9.53	—	—	—	—	THT-152-499-1.5-SC	BBP12, BP-PR+	R7950	1500	2
⬢	B-499	<b>F N A</b>	25.40	9.53	—	—	—	—	THT-152-499-3	BBP12, BP-PR+, IP, i7100, i5100	R4900	3000	2
⬢	B-425	<b>F</b>	25.40	9.98	—	—	—	—	THT-30-425-10	BBP12, BP-PR+, IP, i7100, i5100	R6400	10000	3
<b>0.5 - 8.0 ml</b>													
⊗	B-492	<b>F H L</b>	25.40	9.53	—	9.53	—	—	THT-249-492-1.5-SC	BBP12, BP-PR+	R6400	1500	1
⊗	B-499	<b>F A</b>	25.40	9.53	—	9.53	—	—	THT-249-499-1.5-SC	BBP12, BP-PR+	R7950	1500	1
⊗	B-492	<b>F H L</b>	25.40	12.70	—	9.53	—	—	THT-250-492-1.5-SC	BBP12, BP-PR+	R6400	1500	1
⊗	B-492	<b>F H L</b>	25.40	12.70	—	11.18	—	—	THT-251-492-1.5-SC	BBP12, BP-PR+	R6400	1500	1
<b>0.6 ml</b>													
⊙	B-499	<b>F N A</b>	9.53	—	4.88	—	—	—	M21-375-499	BMP21-LAB	—	1	1
⊙	B-499	<b>F N A</b>	9.53	—	4.88	—	—	—	MC-375-499	BMP51, BMP53	—	1	1
⊙	B-461	<b>F N A H S L</b>	9.53	—	6.40	—	9.53	—	M21-375-461-AW**	BMP21-LAB	—	1	1
▲	B-499	<b>F N A</b>	22.86	12.70	—	—	—	—	B33-125-499	BBP33	B30-R6000HF	1500	1
▲	B-499	<b>F N A</b>	22.86	12.70	—	—	—	—	M71-84-499	BMP71	M71-R4300	500	1
▲	B-499	<b>F N A</b>	22.86	12.70	—	—	—	—	THT-125-499-1.5-SC	BBP12, BP-PR+	R7950	1500	1
▲	B-499	<b>F N A</b>	22.86	12.70	—	—	—	—	THT-125-499-3	BBP12, BP-PR+, IP, i7100, i5100	R4900	3000	1

\*Label is rotated 90° on liner.

\*\*AW = All White / no transparent area.

>>

# Conical / Large Tube Labels

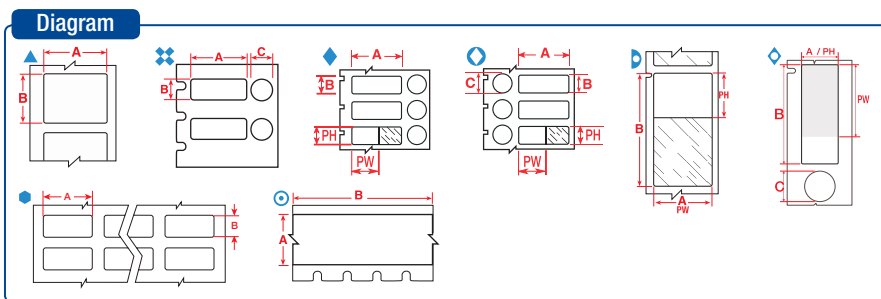

Diagram	Material	Special Properties	Label Width A (mm)	Label Height B (mm)	Label Length B (m)	Diameter C (mm)	Printable Area Width PW (mm)	Printable Area Height PH (mm)	Order Reference	Printer Compatibility	Printer Ribbon Series	Labels per Roll	Labels per Row
<b>1.0 - 2.0 ml</b>													
▷	B-461	<b>FNAHSL</b>	15.00	40.00	-	-	15.00	30.00	BPTLAB-21-461-2.5	BBP12, BP-PR+	R7950	2500	1
▷	B-461	<b>FNAHSL</b>	15.24	38.10	-	-	15.24	33.00	BPT-628-461*	BBP12, BP-PR+	R7950	2500	2
▷	B-461	<b>FNAHSL</b>	15.24	38.10	-	-	15.24	33.00	M71-100-461	BMP71	M71-R6200	500	1
▷	B-461	<b>FNAHSL</b>	15.24	38.10	-	-	15.24	33.03	B33-628-461*	BBP33	B30-R4300	2500	2
◊	B-461	<b>F AHSL</b>	15.24	41.28	-	12.70	15.24	30.00	M71-116-461	BMP71	M71-R6200	150	1
▷	B-461	<b>FNAHSL</b>	15.24	66.68	-	-	15.24	25.40	B33-612-461	BBP33	B30-R4300	1500	3
▷	B-461	<b>FNAHSL</b>	15.24	66.68	-	-	15.24	25.40	BPT-612-461	BBP12, BP-PR+	R7950	1500	3
⊗	B-492	<b>F H L</b>	25.40	9.53	-	9.53	-	-	THT-163-492-3	BBP12, BP-PR+, IP, i7100, i5100	R6400	3000	1
⊗	B-499	<b>F A</b>	25.40	9.53	-	9.53	-	-	THT-163-499-3	BBP12, BP-PR+, IP, i7100, i5100	R4900	3000	1
⊗	B-492	<b>F H L</b>	25.40	12.70	-	9.53	-	-	M71-118-492	BMP71	M71-R6400	500	1
⊗	B-492	<b>F H L</b>	25.40	12.70	-	9.53	-	-	THT-181-492-3	BP-PR+, IP, i7100, i5100	R6400	3000	1
⊗	B-492	<b>F H L</b>	25.40	12.70	-	11.18	-	-	THT-182-492-3	BBP12, BP-PR+, IP, i7100, i5100	R6400	3000	1
◊	B-461	<b>F AHSL</b>	40.00	15.00	-	9.00	30.00	15.00	BPTLAB-20-461-2.5	BBP12, BP-PR+	R7950	2500	1
◊	B-461	<b>F AHSL</b>	40.00	15.00	-	9.53	30.00	15.00	M71-101-461	BMP71	M71-R6200	250	1
◊	B-461	<b>F AHSL</b>	41.28	15.24	-	12.70	30.00	15.24	B33-608-461	BBP33	B30-R4300	1000	1
◊	B-461	<b>F AHSL</b>	41.28	15.24	-	12.70	30.00	15.24	BPT-608-461	BBP12, BP-PR+	R7950	1000	1
⊗	B-499	<b>F A</b>	41.28	15.24	-	12.70	-	-	BPT-608-499	BBP12, BP-PR+	R7950	1000	1
<b>1.0 - 8.0 ml</b>													
▷	B-461	<b>FNAHSL</b>	15.24	41.28	-	-	15.24	25.40	M71-76-461	BMP71	M71-R6200	500	1
▷	B-461	<b>FNAHSL</b>	15.24	66.68	-	-	15.24	25.40	M71-86-461	BMP71	M71-R6200	100	1
▷	B-427	<b>FN S</b>	19.05	44.45	-	-	19.05	12.70	B33-73-427	BBP33	B30-R4300	3500	4
▷	B-427	<b>FN S</b>	19.05	44.45	-	-	19.05	12.70	THT-62-427-3.5*	BBP12, BP-PR+, IP, i7100, i5100	R4300, R7950	3500	1
▷	B-427	<b>FN S</b>	19.05	44.45	-	-	19.05	12.70	THT-73-427-10	BBP12, BP-PR+, IP, i7100, i5100	R4300, R7950	10000	4
▲	B-427	<b>FN S</b>	20.00	20.00	-	-	20.00	20.00	<b>BPTLAB-35-427-YL</b>	BBP12, BP-PR+	R7950	1000	1
⊗	B-499	<b>F A</b>	22.86	12.70	-	12.70	-	-	B33-126-499	BBP33	B30-R6000HF	1500	1
⊗	B-499	<b>F A</b>	22.86	12.70	-	12.70	-	-	M71-126-499	BMP71	M71-R4300	500	1
⊗	B-499	<b>F A</b>	22.86	12.70	-	12.70	-	-	THT-126-499-3	BP-PR+, IP, i7100, i5100	R4900	3000	1
▲	B-499	<b>FNA</b>	22.86	12.70	-	-	-	-	PTL-84-499	BMP61, BMP71	R4310	500	1
▲	B-492	<b>FN H L</b>	25.40	19.05	-	-	-	-	THT-88-492-2.5-SC	BBP12, BP-PR+	R6400	2500	2
▲	B-492	<b>FN H L</b>	25.40	19.05	-	-	-	-	THT-88-492-5	BBP12, BP-PR+, IP, i7100, i5100	R6400	5000	2
▷	B-461	<b>FNAHSL</b>	25.40	66.68	-	-	25.40	25.40	BM71-75-461	BMP61, BMP71	R6200	1000	1
▷	B-461	<b>FNAHSL</b>	25.40	66.68	-	-	25.40	25.40	M71-115-461	BMP71	M71-R6200	100	1
▷	B-461	<b>FNAHSL</b>	25.40	66.68	-	-	25.40	25.40	THT-131-461-1.5-SC*	BBP12, BP-PR+	R7950	1500	1
▷	B-461	<b>FNAHSL</b>	25.40	66.68	-	-	25.40	25.40	THT-131-461-3*	BBP12, BP-PR+, IP, i7100, i5100	R4300, R7950	3000	1
⊗	B-492	<b>F H L</b>	41.28	15.24	-	9.53	-	-	B33-190-492	BBP33	R6400	1500	1
⊗	B-492	<b>F H L</b>	41.28	15.24	-	9.53	-	-	THT-190-492-3	BBP12, BP-PR+, IP, i7100, i5100	R6400	3000	1
▲	B-490	<b>FN H L</b>	41.28	15.24	-	-	-	-	B33-155-490	BBP33	B30-R4300	1500	1
▲	B-492	<b>FN H L</b>	41.28	15.24	-	-	-	-	B33-155-492	BBP33	R6400	1500	1
▲	B-490	<b>FN H L</b>	41.28	15.24	-	-	-	-	M71-76-490	BMP71	M71-R4300	500	1
▲	B-490	<b>FN H L</b>	41.28	15.24	-	-	-	-	THT-155-490-1.5-SC	BBP12, BP-PR+	R7950	1500	1
▲	B-490	<b>FN H L</b>	41.28	15.24	-	-	-	-	THT-155-490-3	BBP12, BP-PR+, IP, i7100, i5100	R4300, R7950	3000	1
▲	B-492	<b>FN H L</b>	41.28	15.24	-	-	-	-	THT-155-492-3	BBP12, BP-PR+, IP, i7100, i5100	R6400	3000	1
▲	B-492	<b>FN H L</b>	44.45	25.40	-	-	-	-	M-125-492	BMP51, BMP53	-	180	1
▲	B-490	<b>FN H L</b>	48.26	25.40	-	-	-	-	B33-156-490	BBP33	B30-R4300	1500	1
▲	B-492	<b>FN H L</b>	48.26	25.40	-	-	-	-	B33-156-492	BBP33	B30-R6400	1500	1
▲	B-492	<b>FN H L</b>	48.26	25.40	-	-	-	-	M71-78-492	BMP71	M71-R6400	250	1
▲	B-499	<b>FNA</b>	48.26	25.40	-	-	-	-	M71-78-499	BMP71	M71-R4300	250	1
▲	B-490	<b>FN H L</b>	48.26	25.40	-	-	-	-	THT-156-490-1.5-SC	BBP12, BP-PR+	R7950	1500	1
▲	B-490	<b>FN H L</b>	48.26	25.40	-	-	-	-	THT-156-490-3	BBP12, BP-PR+, IP, i7100, i5100	R4300, R7950	3000	1
▲	B-492	<b>FN H L</b>	48.26	25.40	-	-	-	-	THT-156-492-1.5-SC	BBP12, BP-PR+	R6400	1500	1
▲	B-492	<b>FN H L</b>	48.26	25.40	-	-	-	-	THT-156-492-3	BBP12, BP-PR+, IP, i7100, i5100	R6400	3000	1

\*Label is rotated 90° on liner.

>>

# Conical / Large Tube Labels

Diagram

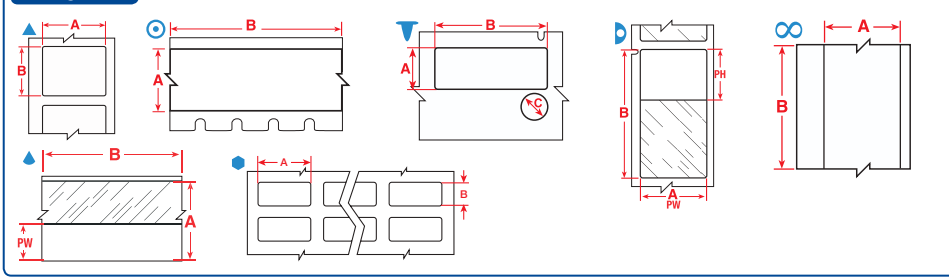

Labels are shown per vial / tube size and in order of label width.

The background colours in the Order Reference column represent the material colour.

See page 42 for Brady's range of label printers.

Diagram	Material	Special Properties	Label Width A (mm)	Label Height B (mm)	Label Length B (m)	Diameter C (mm)	Printable Area Width PW (mm)	Printable Area Height PH (mm)	Order Reference	Printer Compatibility	Printer Ribbon Series	Labels per Roll	Labels per Row
<b>1.0 - 15.0 ml</b>													
▲	B-492	<b>F N H L</b>	22.86	25.40	-	-	-	-	M-156-492	BMP51, BMP53	-	180	1
<b>1.5 ml</b>													
○	B-499	<b>F N A</b>	12.70	-	4.88	-	-	-	M21-500-499	BMP21-LAB	-	1	1
○	B-499	<b>F N A</b>	12.70	-	4.88	-	-	-	MC-500-499	BMP51, BMP53	-	1	1
○	B-461	<b>F N A H S L</b>	12.70	-	6.40	-	12.70	-	M21-500-461-AW**	BMP21-LAB	-	1	1
○	B-499	<b>F N A</b>	12.70	-	9.10	-	-	-	M71C-500-499	BMP71	M71-R4300	1	1
∞	B-430	<b>F A H</b>	12.70	-	15.24	-	12.70	152.4	PTL-8-430	BMP61, BMP71	R6010	1	1
<b>1.5 - 2.0 ml</b>													
▷	B-461	<b>F N A H S L</b>	15.24	41.28	-	-	15.24	25.40	B33-133-461	BBP33	B30-R4300	1500	3
▷	B-461	<b>F N A H S L</b>	15.24	41.28	-	-	15.24	25.40	THT-133-461-1.5-SC*	BBP12, BP-PR+	R7950	1500	1
▷	B-461	<b>F N A H S L</b>	15.24	41.28	-	-	15.24	25.40	THT-133-461-3*	BBP12, BP-PR+, IP, i7100, i5100	R4300, R7950	3000	1
▷	B-461	<b>F N A H S L</b>	15.24	66.68	-	-	15.24	25.40	THT-153-461-1.5-SC*	BBP12, BP-PR+	R7950	1500	1
▷	B-461	<b>F N A H S L</b>	15.24	66.68	-	-	15.24	25.40	THT-153-461-3*	BBP12, BP-PR+, IP, i7100, i5100	R4300, R7950	3000	1
▲	B-492	<b>F N H L</b>	25.40	12.70	-	-	-	-	B33-59-492	BBP33	B30-R6400	2500	1
⬢	B-430	<b>F A H</b>	25.40	12.70	-	-	-	-	THT-39-430-10	BBP12, BP-PR+, IP, i7100, i5100	R6000HF	10000	3
▲	B-492	<b>F N H L</b>	25.40	12.70	-	-	-	-	THT-59-492-10	BBP12, BP-PR+, IP, i7100, i5100	R6400	10000	1
▲	B-492	<b>F N H L</b>	25.40	12.70	-	-	-	-	THT-59-492-2.5-SC	BBP12, BP-PR+	R6400	2500	1
▽	B-492	<b>F H L</b>	41.28	15.24	-	9.53	-	-	M-95-492	BMP51, BMP53	-	200	1
▲	B-492	<b>F N H L</b>	41.91	12.70	-	-	-	-	M-124-492	BMP51, BMP53	-	180	1
<b>2.0 - 4.0 ml</b>													
▷	B-461	<b>F N A H S L</b>	15.24	48.26	-	-	15.24	40.00	B33-638-461*	BBP33	B30-R4300	2000	1
▷	B-461	<b>F N A H S L</b>	15.24	48.26	-	-	15.24	40.00	BPT-638-461*	BBP12, BP-PR+	R7950	2000	1
▷	B-461	<b>F N A H S L</b>	15.24	48.26	-	-	15.24	40.00	M71-119-461	BMP71	M71-R6200	500	1
<b>2.0 - 50.0 ml</b>													
▲	B-427	<b>F N S</b>	19.05	-	4.30	-	9.53	-	M21-750-427	BMP21-LAB	-	1	-
○	B-499	<b>F N A</b>	19.05	-	4.88	-	-	-	M21-750-499	BMP21-LAB	-	1	1
○	B-499	<b>F N A</b>	19.05	-	4.88	-	-	-	MC-750-499	BMP51, BMP53	-	1	1
○	B-461	<b>F N A H S L</b>	19.05	-	6.40	-	19.05	-	M21-750-461-AW**	BMP21-LAB	-	1	1
▲	B-427	<b>F N S</b>	19.05	-	7.62	-	9.53	-	MC-750-427	BMP51, BMP53	-	1	1
○	B-427	<b>F N S</b>	25.40	-	4.30	-	9.53	-	M21-1000-427	BMP21-LAB	-	1	-
○	B-499	<b>F N A</b>	25.40	-	4.88	-	-	-	MC-1000-499	BMP51, BMP53	-	1	1
▲	B-427	<b>F N S</b>	25.40	-	7.62	-	9.53	-	MC-1000-427	BMP51, BMP53	-	1	1
○	B-461	<b>F N A H S L</b>	25.40	-	7.62	-	25.40	-	MC-1000-461-AW**	BMP51, BMP53	-	1	1
○	B-499	<b>F N A</b>	25.40	-	9.10	-	-	-	M71C-1000-499	BMP71	M71-R4300	1	1
<b>4.0 - 8.0 ml</b>													
⬢	B-499	<b>F N A</b>	25.40	66.68	-	-	-	-	B33-625-499	BBP33	B30-R6000HF	1500	3
⬢	B-499	<b>F N A</b>	25.40	66.68	-	-	-	-	BPT-625-499	BBP12, BP-PR+	R7950	1500	3
<b>4.0 - 50.0 ml</b>													
▲	B-427	<b>F N S</b>	30.48	-	4.30	-	12.70	-	M21-1250-427	BMP21-LAB	-	1	-
▲	B-427	<b>F N S</b>	31.75	-	7.62	-	12.70	-	MC-1250-427	BMP51, BMP53	-	1	1
○	B-461	<b>F N A H S L</b>	31.75	-	7.62	-	31.75	-	MC-1250-461-AW**	BMP51, BMP53	-	1	1
▷	B-461	<b>F N A H S L</b>	34.93	45.72	-	-	34.93	40.00	B33-632-461*	BBP33	B30-R4300	1500	1
▷	B-461	<b>F N A H S L</b>	34.93	45.72	-	-	34.93	40.00	BPT-632-461*	BBP12, BP-PR+	R7950	2000	1

\*Label is rotated 90° on liner. \*\*AW = All White / no transparent area.

>>



# Conical / Large Tube Labels

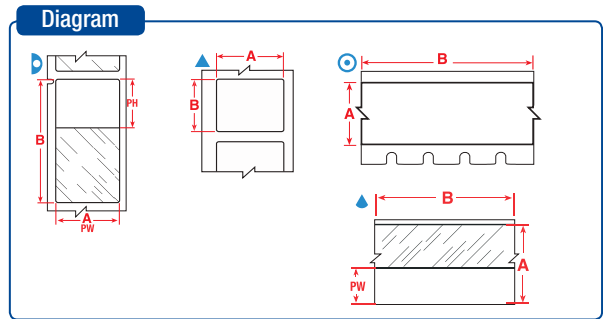

Labels are shown per vial / tube size and in order of label width.

The background colours in the Order Reference column represent the material colour.

See page 42 for Brady's range of label printers.

Diagram	Material	Special Properties	Label Width A (mm)	Label Height B (mm)	Label Length B (m)	Diameter C (mm)	Printable Area Width PW (mm)	Printable Area Height PH (mm)	Order Reference	Printer Compatibility	Printer Ribbon Series	Labels per Roll	Labels per Row
<b>5.0 - 50.0 ml</b>													
▲	B-427	<b>F N S</b>	38.10	-	4.30	-	12.70	-	M21-1500-427	BMP21-LAB	-	1	-
▲	B-427	<b>F N S</b>	38.10	-	7.62	-	12.70	-	MC-1500-427	BMP51, BMP53	-	1	1
◎	B-499	<b>F N A</b>	48.26	-	9.10	-	-	-	M71C-1900-499	BMP71	M71-R4300	1	1
<b>12.0 - 14.0 ml</b>													
▷	B-461	<b>F N A H S L</b>	38.10	95.25	-	-	38.10	31.75	M-119-461	BMP51, BMP53	-	80	1
<b>12.0 - 24.0 ml</b>													
▲	B-492	<b>F N H L</b>	25.40	48.26	-	-	-	-	M-78-492	BMP51, BMP53	-	100	1
▲	B-498	<b>F R</b>	38.10	12.70	-	-	-	-	BM71-29-498	BMP61, BMP71	R6200	5000	1
▲	B-498	<b>F R</b>	38.10	12.70	-	-	-	-	M71-29-498	BMP71	M71-R6200	500	1
▲	B-499	<b>F N A</b>	38.10	12.70	-	-	-	-	M71-29-499	BMP71	M71-R4300	500	1
▲	B-498	<b>F R</b>	38.10	12.70	-	-	-	-	PTL-29-498	BMP61, BMP71	R6210	500	1
▲	B-499	<b>F N A</b>	38.10	12.70	-	-	-	-	PTL-29-499	BMP61, BMP71	R4310	500	1
▲	B-499	<b>F N A</b>	38.10	31.75	-	-	-	-	M-132-499	BMP51, BMP53	-	160	1
▷	B-461	<b>F N A H S L</b>	38.10	88.90	-	-	38.10	31.75	PTL-77-461	BMP61, BMP71	R4310	100	1
<b>12.0 - 50.0 ml</b>													
▷	B-461	<b>F N A H S L</b>	25.40	133.35	-	-	25.40	38.10	B33-139-461	BBP33	B30-R4300	650	2
▷	B-461	<b>F N A H S L</b>	25.40	133.35	-	-	25.40	38.10	THT-139-461-2	BBP12, BP-PR+, IP, i7100, i5100	R4300, R7950	2000	2
<b>14.0 - 15.0 ml</b>													
▲	B-490	<b>F N H L</b>	38.10	55.88	-	-	-	-	M-113-490	BMP51, BMP53	-	140	1
▷	B-461	<b>F N A H S L</b>	38.10	57.15	-	-	38.10	31.75	M-129-461	BMP51, BMP53	-	140	1
▷	B-427	<b>F N S</b>	38.10	63.50	-	-	38.10	19.05	B33-517-427	BBP33	B30-R4300	1000	2
▷	B-427	<b>F N S</b>	38.10	63.50	-	-	38.10	19.05	BPT-517-427	BBP12, BP-PR+	R7950	2000	2
▷	B-427	<b>F N S</b>	38.10	63.50	-	-	38.10	19.05	M-116-427	BMP51, BMP53	-	80	1
▲	B-490	<b>F N H L</b>	55.88	38.10	-	-	-	-	PTL-113-490	BMP61, BMP71	R4310	100	1
▲	B-490	<b>F N H L</b>	55.88	38.10	-	-	-	-	THT-157-490-1.5-SC	BBP12, BP-PR+	R7950	1500	1
▲	B-490	<b>F N H L</b>	55.88	38.10	-	-	-	-	THT-157-490-3	BBP12, BP-PR+, IP, i7100, i5100	R4300, R7950	3000	1

\*Label is rotated 90° on liner. \*\*AW = All White / no transparent area.

>>

# Conical / Large Tube Labels

Diagram

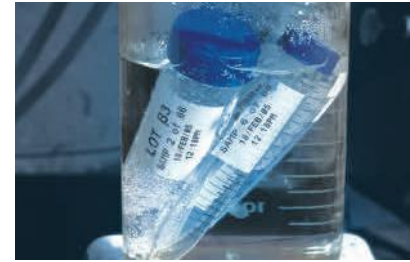
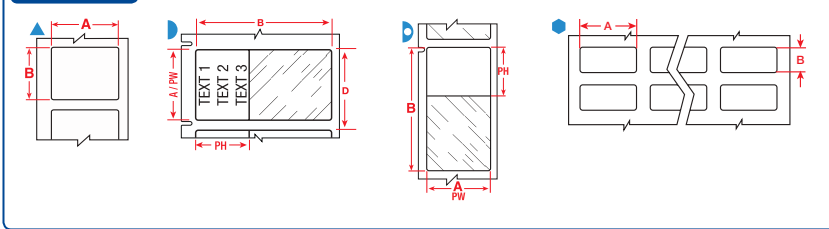

Labels are shown per vial / tube size and in order of label width.

The background colours in the Order Reference column represent the material colour.

See page 42 for Brady's range of label printers.

Diagram	Material	Special Properties	Label Width A (mm)	Label Height B (mm)	Label Length B (m)	Diameter C (mm)	Printable Area Width PW (mm)	Printable Area Height PH (mm)	Order Reference	Printer Compatibility	Printer Ribbon Series	Labels per Roll	Labels per Row
<b>15.0 - 50.0 ml</b>													
▲	B-498	<b>F</b>	20.32	36.50	-	-	20.32	36.50	THT-95-498-5	BBP12, BP-PR+, IP, i7100, i5100	R4300, R7950	5000	3
●	B-499	<b>FNA</b>	20.32	36.50	-	-	36.50	20.32	THT-69-499-3	BBP12, BP-PR+, IP, i7100, i5100	R4900	3000	2
●	B-499	<b>FNA</b>	20.32	36.50	-	-	-	-	B33-165-499	BBP33	B30-R6000HF	2500	4
●	B-498	<b>F</b>	20.32	36.50	-	-	-	-	B33-95-498	BBP33	B30-R6200	2300	3
●	B-499	<b>FNA</b>	22.86	38.10	-	-	-	-	BPT-618-499	BBP12, BP-PR+	R7950	3000	3
●	B-498	<b>F</b>	25.40	36.50	-	-	36.50	25.40	THT-89-498-5	BBP12, BP-PR+, IP, i7100, i5100	R4300, R7950	5000	3
●	B-499	<b>FNA</b>	25.40	36.50	-	-	-	-	B33-621-499	BBP33	B30-R6000HF	3000	3
●	B-498	<b>F</b>	25.40	36.50	-	-	-	-	BPT-621-498	BBP12, BP-PR+	R7950	3000	3
●	B-499	<b>FNA</b>	25.40	36.50	-	-	-	-	BPT-621-499	BBP12, BP-PR+	R7950	3000	3
▷	B-461	<b>FNAHSL</b>	25.40	66.68	-	-	25.40	25.40	B33-276-461	BBP33	B30-R4300	1500	2
▷	B-461	<b>FNAHSL</b>	38.10	19.05	-	-	33.00	19.05	BPT-629-461*	BBP12, BP-PR+	R7950	2500	2
▷	B-461	<b>FNAHSL</b>	38.10	88.90	-	-	38.10	31.75	B33-134-461*	BBP33	B30-R4300	1000	1
▷	B-461	<b>FNAHSL</b>	38.10	88.90	-	-	38.10	31.75	THT-134-461-3*	BBP12, BP-PR+, IP, i7100, i5100	R4300, R7950	3000	1
▲	B-461	<b>FNAHSL</b>	48.26	25.40	-	-	48.26	25.40	B33-636-461AW**	BBP33	B30-R4300	2000	1
▲	B-461	<b>FNAHSL</b>	48.26	25.40	-	-	48.26	25.40	BPT-636-461-AW**	BBP12, BP-PR+	R7950	2000	1
▲	B-427	<b>FN S</b>	55.88	38.10	-	-	55.88	38.10	B33-640-427AW**	BBP33	B30-R4300	1500	1
▲	B-427	<b>FN S</b>	55.88	38.10	-	-	55.88	38.10	BPT-640-427-AW**	BBP12, BP-PR+	R7950	2000	1
▲	B-461	<b>FNAH L</b>	57.15	19.05	-	-	57.15	19.05	B33-642-461AW**	BBP33	B30-R4300	2000	1
▲	B-461	<b>FNAHSL</b>	57.15	19.05	-	-	57.15	19.05	BPT-642-461-AW**	BBP12, BP-PR+	R7950	2000	1
▲	B-427	<b>FN S</b>	66.68	25.40	-	-	66.68	25.40	B33-648-427AW**	BBP33	B30-R4300	1500	1
▲	B-427	<b>FN S</b>	66.68	25.40	-	-	66.68	25.40	BPT-648-427-AW**	BBP12, BP-PR+	R7950	2000	1
▲	B-461	<b>FNAHSL</b>	88.90	38.10	-	-	88.90	38.10	B33-650-461AW**	BBP33	B30-R4300	2000	1
▲	B-461	<b>FNAHSL</b>	88.90	38.10	-	-	88.90	38.10	BPT-650-461-AW**	BBP12, BP-PR+	R7950	2000	1
<b>50.0 ml</b>													
▲	B-423	<b>F AH</b>	12.70	12.70	-	-	-	-	BM71-7-423	BMP61, BMP71	R6000HF	5000	1
▲	B-423	<b>F AH</b>	12.70	12.70	-	-	-	-	M71-7-423	BMP71	M71-R6000HF	500	1
▲	B-423	<b>F A</b>	12.70	12.70	-	-	-	-	PTL-7-423	BMP61, BMP71	R6010	500	1
▷	B-427	<b>FN S</b>	19.05	38.10	-	-	19.05	12.70	BM71-30-427	BMP61, BMP71	R4300	2500	1
▷	B-427	<b>FN S</b>	19.05	38.10	-	-	19.05	12.70	M71-30-427	BMP71	M71-R4300	250	1
▷	B-427	<b>FN S</b>	19.05	38.10	-	-	19.05	12.70	M-90-427	BMP51, BMP53	-	180	1
▷	B-461	<b>FNAHSL</b>	19.05	38.10	-	-	19.05	33.02	B33-629-461*	BBP33	B30-R4300	2500	2
▲	B-492	<b>FN H L</b>	22.86	25.40	-	-	-	-	THT-180-492-3	BBP12, BP-PR+, IP, i7100, i5100	R6400	3000	1
▲	B-423	<b>F A</b>	25.4	76.2	-	-	-	-	PTL-22-423	BMP61, BMP71	R6010	100	1
▲	B-423	<b>F AH</b>	25.40	4.75	-	-	-	-	M71-14-423	BMP71	M71-R6000HF	750	1
▲	B-423	<b>F A</b>	25.40	4.75	-	-	-	-	PTL-14-423	BMP61, BMP71	R6010	750	1
●	B-423	<b>F AH</b>	25.40	4.75	-	-	-	-	THT-41-423-10	BBP12, BP-PR+, IP, i7100, i5100	R6000HF	10000	3
●	B-423	<b>F AH</b>	25.40	6.35	-	-	-	-	THT-51-423-10	BBP12, BP-PR+, IP, i7100, i5100	R6000HF	10000	3
▲	B-423	<b>F AH</b>	25.40	6.99	-	-	-	-	M71-15-423	BMP71	M71-R6000HF	750	1
▲	B-423	<b>F A</b>	25.40	6.99	-	-	-	-	PTL-15-423	BMP61, BMP71	R6010	750	1
▲	B-498	<b>F</b>	25.40	12.70	-	-	25.40	12.70	PTL-17-498	BMP61, BMP71	R6210	500	1
▲	B-423	<b>F AH</b>	25.40	12.70	-	-	-	-	M71-17-423	BMP71	M71-R6000HF	500	1
▲	B-492	<b>FN H L</b>	25.40	12.70	-	-	-	-	M71-17-492	BMP71	M71-R6400	500	1
▲	B-498	<b>F</b>	25.40	12.70	-	-	-	-	M71-17-498	BMP71	M71-R6200	500	1

\*Label is rotated 90° on liner. \*\*AW = All White / no transparent area.

>>

**F** Freezer environment **N** Liquid nitrogen environment **A** Autoclave environment **H** Hot water bath (100°C) **S** Self-laminating label **L** Low-profile (extremely thin) label **R** Removable

# Conical / Large Tube Labels

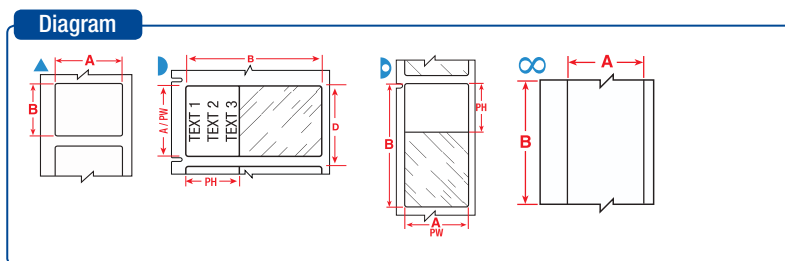

Diagram	Material	Special Properties	Label Width A (mm)	Label Height B (mm)	Label Length B (m)	Diameter C (mm)	Printable Area Height PH (mm)	Printable Area Width PW (mm)	Order Reference	Printer Compatibility	Printer Ribbon Series	Labels per Roll	Labels per Row
▲	B-423	F A	25.40	12.70	-	-	-	-	PTL-17-423	BMP61, BMP71	R6010	500	1
▲	B-430	F AH	25.40	12.70	-	-	-	-	PTL-17-430	BMP61, BMP71	R6010	500	1
▲	B-492	F N H L	25.40	25.40	-	-	-	-	B33-179-492	BBP33	B30-R6400	1900	1
▲	B-492	F N H L	25.40	25.40	-	-	-	-	THT-179-492-2.5-SC	BBP12, BP-PR+	R6400	2500	1
▲	B-492	F N H L	25.40	25.40	-	-	-	-	THT-179-492-3	BBP12, BP-PR+, IP, i7100, i5100	R6400	3000	1
◐	B-427	F N S	25.40	38.10	-	-	25.40	12.70	BM71-31-427	BMP61, BMP71	R4300	2500	1
◐	B-427	F N S	25.40	38.10	-	-	25.40	12.70	M71-31-427	BMP71	M71-R4300	250	1
◐	B-461	F N A H S L	25.40	38.10	-	-	25.40	12.70	M71-31-461	BMP71	M71-R6200	250	1
◐	B-427	F N S	25.40	38.10	-	-	25.40	12.70	M-91-427	BMP51, BMP53	-	180	1
▲	B-499	F N A	25.40	48.26	-	-	-	-	M-128-499	BMP51, BMP53	-	100	1
▲	B-427	F N S	25.40	50.80	-	-	25.40	50.80	THT-137-427-3-AW**	BBP12, BP-PR+, IP, i7100, i5100	R4300, R7950	3000	1
▲	B-423	F AH	25.40	50.80	-	-	-	-	BM71-20-423	BMP61, BMP71	R6000HF	1000	1
▲	B-423	F AH	25.40	50.80	-	-	-	-	M71-20-423	BMP71	M71-R6000HF	100	1
▲	B-499	F N A	25.40	63.50	-	-	-	-	M71-21-499	BMP71	M71-R4300	100	1
▲	B-423	F AH	25.40	76.20	-	-	-	-	M71-22-423	BMP71	M71-R6000HF	100	1
∞	B-439	F	25.40	-	15.24	-	-	-	PTL-42-439	BMP61, BMP71	R6010	1	1
∞	B-439	F	25.40	-	15.24	-	-	-	PTL-42-439-OR	BMP61, BMP71	R6010	1	1
∞	B-439	F	25.40	-	15.24	-	-	-	PTL-42-439-RD	BMP61, BMP71	R6010	1	1
∞	B-439	F	25.40	-	15.24	-	-	-	PTL-42-439-YL	BMP61, BMP71	R6010	1	1
▲	B-427	F N S	38.10	19.05	-	-	38.10	19.05	B33-135-427AW**	BBP33	B30-R4300	1500	1
▲	B-427	F N S	38.10	19.05	-	-	38.10	19.05	M71-30-427-AW**	BMP71	M71-R4300	250	1
▲	B-427	F N	38.10	19.05	-	-	38.10	19.05	PTL-30-427-AW***	BMP61, BMP71	R4310	250	1
▲	B-427	F N S	38.10	19.05	-	-	38.10	19.05	THT-135-427-3-AW**	BBP12, BP-PR+, IP, i7100, i5100	R4300, R7950	3000	1
▲	B-499	F N A	38.10	19.05	-	-	-	-	B33-136-499	BBP33	B30-R6000HF	1500	1
▲	B-499	F N A	38.10	19.05	-	-	-	-	M71-30-499	BMP71	M71-R4300	250	1
▲	B-499	F N A	38.10	19.05	-	-	-	-	PTL-30-499	BMP61, BMP71	R4310	250	1
▲	B-499	F N A	38.10	19.05	-	-	-	-	THT-136-499-1.5-SC	BBP12, BP-PR+	R7950	1500	1
▲	B-499	F N A	38.10	19.05	-	-	-	-	THT-136-499-3	BBP12, BP-PR+, IP, i7100, i5100	R4900	3000	1
▲	B-423	F AH	38.10	25.40	-	-	-	-	M71-31-423	BMP71	M71-R6000HF	250	1
▲	B-498	F R	38.10	25.40	-	-	-	-	M71-31-498	BMP71	M71-R6200	250	1
▲	B-499	F N A	38.10	25.40	-	-	-	-	M71-31-499	BMP71	M71-R4300	250	1
▲	B-423	F A	38.10	25.40	-	-	-	-	PTL-31-423	BMP61, BMP71	R6010	250	1
▲	B-498	F R	38.10	25.40	-	-	-	-	PTL-31-498	BMP61, BMP71	R6210	250	1
▲	B-499	F N A	38.10	25.40	-	-	-	-	PTL-31-499	BMP61, BMP71	R4310	250	1
▲	B-490	F N H L	38.10	98.42	-	-	-	-	M-114-490	BMP51, BMP53	-	80	1
▲	B-490	F N H L	38.10	98.43	-	-	-	-	PTL-114-490	BMP61, BMP71	R4310	100	1
▲	B-427	F N	48.26	25.40	-	-	48.26	25.40	PTL-78-427-AW***	BMP61, BMP71	R4310	250	1
▲	B-499	F N A	48.26	25.40	-	-	48.26	25.40	PTL-78-499	BMP61, BMP71	R4310	250	1
▲	B-488	F A	48.26	25.40	-	-	-	-	PTL-78-488	BMP61, BMP71	R4310	250	1
▲	B-490	F N H L	50.80	6.35	-	-	-	-	B33-151-490	BBP33	B30-R4300	2500	1
▲	B-427	F N S	50.80	25.40	-	-	50.80	25.40	B33-137-427AW**	BBP33	B30-R4300	1500	1
▲	B-499	F N A	50.80	25.40	-	-	-	-	B33-137-499	BBP33	B30-R6000HF	1100	1
▲	B-423	F A	50.80	25.40	-	-	-	-	PTL-20-423	BMP61, BMP71	R6010	100	1
▲	B-499	F N A	50.80	25.40	-	-	-	-	THT-137-499-1.5-SC	BBP12, BP-PR+	R7950	1500	1
▲	B-499	F N A	50.80	25.40	-	-	-	-	THT-137-499-3	BBP12, BP-PR+, IP, i7100, i5100	R4900	3000	1
▲	B-490	F N H L	95.25	38.10	-	-	-	-	THT-158-490-1.5-SC	BBP12, BP-PR+	R7950	1500	1
▲	B-490	F N H L	95.25	38.10	-	-	-	-	THT-158-490-3	BBP12, BP-PR+, IP, i7100, i5100	R4300, R7950	3000	1

\*Label is rotated 90° on liner. \*\*AW = All White / no transparent area.

F Freezer environment N Liquid nitrogen environment A Autoclave environment H Hot water bath (100°C) S Self-laminating label L Low-profile (extremely thin) label R Removable

## SLIDE LABELS

Brady offers labels specifically designed to identify slides and to resist exposure to harsh chemicals during the slide staining process. They perform well in the hematoxylin and eosin slide staining process and offer superior chemical resistance also useful in other laboratory contexts.



Diagram

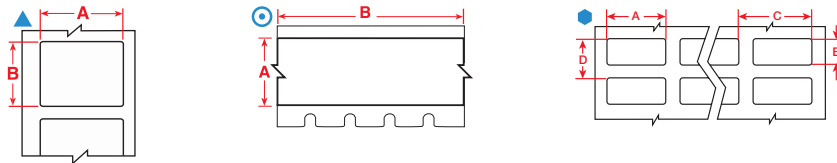

- F** Freezer environment
- N** Liquid nitrogen environment
- A** Autoclave environment
- H** Hot water bath (100°C)
- S** Self-laminating label
- L** Low-profile (extremely thin) label
- R** Removable

Labels are shown in order of label width.

The background colours in the Order Reference column represent the material colour.

See page 42 for Brady's range of label printers.

Diagram	Material	Special Properties	Label Width A (mm)	Label Height B (mm)	Label Length B (m)	Order Reference	Printer Compatibility	Printer Ribbon Series	Labels per Roll	Labels per Row
▲	B-488	<b>F</b> <b>A</b>	6.35	48.26	–	M-81-488	BMP51, BMP53	–	160	1
⊙	B-488	<b>F</b> <b>A</b>	9.53	–	6.40	M21-375-488	BMP21-LAB	–	1	1
⊙	B-488	<b>F</b> <b>A</b>	12.70	–	6.40	M21-500-488	BMP21-LAB	–	1	1
▲	B-488	<b>F</b> <b>A</b>	19.05	22.86	–	M71-80-488	BMP71	M71-R4300	250	1
▲	B-488	<b>F</b> <b>A</b>	19.05	22.86	–	PTL-80-488	BMP61, BMP71	R4310	250	1
⊙	B-488	<b>F</b> <b>A</b>	19.05	–	6.40	M21-750-488	BMP21-LAB	–	1	1
▲	B-481	<b>F</b> <b>H</b>	22.86	9.53	–	B33-195-481	BBP33	B30-R6400	3000	1
▲	B-481	<b>F</b> <b>H</b>	22.86	9.53	–	THT-195-481-3	BBP12, BP-PR+, IP, i7100, i5100	R6400	3000	1
⬢	B-488	<b>F</b> <b>A</b>	22.86	19.05	–	B33-616-488	BBP33	B30-R4300	3000	3
▲	B-481	<b>F</b> <b>H</b>	22.86	19.05	–	B33-194-481	BBP33	B30-R6400	2000	1
⬢	B-488	<b>F</b> <b>A</b>	22.86	19.05	–	BPT-616-488	BBP12, BP-PR+	R7950	3000	3
▲	B-481	<b>F</b> <b>H</b>	22.86	19.05	–	BPT-194-481	BBP12, BP-PR+	R6400	2500	1
▲	B-481	<b>F</b> <b>H</b>	22.86	19.05	–	M-194-481	BMP51, BMP53	–	320	1
▲	B-481	<b>F</b> <b>H</b>	22.86	19.05	–	THT-194-481-3	BBP12, BP-PR+, IP, i7100, i5100	R6400	3000	1
⬢	B-488	<b>F</b> <b>A</b>	22.86	19.05	–	THT-140-488-3	BBP12, BP-PR+, IP, i7100, i5100	R4300, R7950	3000	2
⬢	B-488	<b>F</b> <b>A</b>	22.86	19.05	–	THT-140-488-1.5-SC	BBP12, BP-PR+	R7950	1500	2
⬢	B-488	<b>F</b> <b>A</b>	22.86	22.86	–	B33-617-488	BBP33	B30-R4300	3000	3
⬢	B-488	<b>F</b> <b>A</b>	22.86	22.86	–	BPT-617-488	BBP12, BP-PR+	R7950	3000	3
▲	B-481	<b>F</b> <b>H</b>	22.86	22.86	–	BPT-164-481	BBP12, BP-PR+	R6400	2500	1
▲	B-488	<b>F</b> <b>A</b>	22.86	22.86	–	M-97-488	BMP51, BMP53	–	180	1
▲	B-481	<b>F</b> <b>H</b>	22.86	22.86	–	M-97-481	BMP51, BMP53	–	280	1
▲	B-488	<b>F</b> <b>A</b>	22.86	22.86	–	M71-97-488	BMP71	M71-R4300	250	1
▲	B-481	<b>F</b> <b>H</b>	22.86	22.86	–	M71-97-481	BMP71	M71-R6400	250	1
▲	B-488	<b>F</b> <b>A</b>	22.86	22.86	–	PTL-97-488	BMP61, BMP71	R4310	250	1
⬢	B-481	<b>F</b> <b>H</b>	22.86	22.86	–	THT-207-481-2.5-SC	BBP12, BP-PR+	R6400	2500	4
▲	B-488	<b>F</b> <b>A</b>	22.86	22.86	–	THT-164-488-1	BBP12, BP-PR+, IP, i7100, i5100	R4300, R7950	1000	1
▲	B-481	<b>F</b> <b>H</b>	22.86	22.86	–	THT-164-481-3	BBP12, BP-PR+, IP, i7100, i5100	R6400	3000	1
⬢	B-488	<b>F</b> <b>A</b>	22.86	22.86	–	THT-141-488-3	BBP12, BP-PR+, IP, i7100, i5100	R4300, R7950	3000	2
⬢	B-481	<b>F</b> <b>H</b>	22.86	22.86	–	THT-141-481-3	BBP12, BP-PR+, IP, i7100, i5100	R6400	3000	2
⬢	B-481	<b>F</b> <b>H</b>	22.90	22.90	–	THT-141-481-1.5-SC	BBP12, BP-PR+	R6400	1500	2
▲	B-481	<b>F</b> <b>H</b>	25.40	9.53	–	M-195-481	BMP51, BMP53	–	320	1
▲	B-488	<b>F</b> <b>A</b>	48.26	6.35	–	B33-635-488	BBP33	B30-R4300	2000	1
▲	B-488	<b>F</b> <b>A</b>	50.80	6.35	–	THT-15-488-2.5	BBP12, BP-PR+, IP, i7100, i5100	R4300, R7950	2500	1
▲	B-481	<b>F</b> <b>H</b>	63.50	5.08	–	THT-142-481-2.5	BBP12, BP-PR+, IP, i7100, i5100	R6400	2500	1
▲	B-481	<b>F</b> <b>H</b>	63.50	5.08	–	THT-142-481-2.5-SC	BBP12, BP-PR+	R6400	2500	1

**F** Freezer environment **N** Liquid nitrogen environment **A** Autoclave environment **H** Hot water bath (100°C) **S** Self-laminating label **L** Low-profile (extremely thin) label **R** Removable



## TISSUE CASSETTE LABELS

Specifically designed to identify tissue cassettes, Brady's B-482 label withstands a temperature range from -80°C to 121°C and offers superior resistance to chemicals used in tissue processing enabling it to retain barcode legibility. The label must be used in combination with Brady's BSP31 Label Attachment System for pre-process tissue cassette identification and complements the use of StainerBondz slide labels as part of a complete histology process.

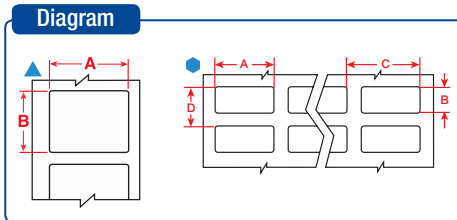

- F** Freezer environment
- N** Liquid nitrogen environment
- A** Autoclave environment
- H** Hot water bath (100°C)
- S** Self-laminating label
- L** Low-profile (extremely thin) label
- R** Removable

Labels are shown in order of label width.

The background colours in the Order Reference column represent the material colour.

See page 42 for Brady's range of label printers.

Diagram	Material	Special Properties	Label Width A (mm)	Label Height B (mm)	Order Reference	Printer Compatibility	Printer Ribbon Series	Labels per Roll	Labels per Row
▲	B-482	<b>F</b> <b>H</b>	26.67	6.35	B33-199-482	BBP33	B30-R6400	3000	1
▲	B-482	<b>F</b> <b>H</b>	26.67	6.35	M-127-482	BMP51, BMP53	–	360	1
▲	B-482	<b>F</b> <b>H</b>	26.67	6.35	THT-199-482-3	BBP12, BP-PR+, IP, i7100, i5100	R6400	3000	1
▲	B-482	<b>F</b> <b>H</b>	26.67	6.35	THT-199-482-3-SC	BBP12, BP-PR+	R6400	3000	1
▲	B-482	<b>F</b> <b>H</b>	26.67	7.95	B33-213-482	BBP33	B30-R6400	3000	1
▲	B-482	<b>F</b> <b>H</b>	26.67	7.95	THT-213-482-3	BBP12, BP-PR+, IP, i7100, i5100	R6400	3000	1
▲	B-482	<b>F</b> <b>H</b>	26.67	7.95	THT-213-482-3-SC	BBP12, BP-PR+, IP, i5100	R6400	3000	1

### i



### Specimen Labelling Solution for Histology and Anatomic Pathology

As part of Brady's complete laboratory labelling solution, our combination of the B-482 Tissue Cassette label and the BSP31 Label Attachment System, **ensures your specimen will stick throughout processing, embedding and sectioning.** See page 54 for more information on the BSP31.

### i



### B-498 Re-Identify Tissue Cassettes Labels

Tissue cassettes are often re-identified when labs collect samples from various biorepositories. Typically, each laboratory has its own unique way of identifying samples, which creates a need to re-identify samples in a common way.

Brady B-498 post-process labels offer customers the optimal way to organise these specimens and conduct further studies. These labels can be applied directly onto the cassettes, on pure paraffin wax and on top of another label or identifier.

This is not the same as Brady's B-482 tissue cassette solution. **B-498 Re-identify labels are applied after processing and are never used with the BSP31 label attachment system.**

Diagram	Material	Special Properties	Label Width A (mm)	Label Height B (mm)	Order Reference	Printer Compatibility	Printer Ribbon Series	Labels per Roll	Labels per Row
●	B-498	<b>F</b> <b>R</b>	19.05	6.35	B33-1-498	BBP33	B30-R6200	5000	4
▲	B-498	<b>F</b> <b>R</b>	19.05	6.35	M71-10-498	BMP71	M71-R6200	750	1
▲	B-498	<b>F</b> <b>R</b>	19.05	6.35	THT-252-498-3	BBP12, BP-PR+, IP, i7100, i5100	R4300, R7950	3000	1
▲	B-498	<b>F</b> <b>R</b>	19.05	6.35	THT-252-498-3-SC	BBP12, BP-PR+	R7950	3000	1
●	B-498	<b>F</b> <b>R</b>	19.05	6.35	THT-1-498-10	BBP12, BP-PR+, IP, i7100, i5100	R4300, R7950	10000	4
▲	B-498	<b>F</b> <b>R</b>	19.05	12.70	M-11-498	BMP51, BMP53	–	220	1
▲	B-498	<b>F</b> <b>R</b>	19.05	19.05	THT-254-498-3	BBP12, BP-PR+, IP, i7100, i5100	R4300, R7950	3000	1
▲	B-498	<b>F</b> <b>R</b>	19.05	19.05	THT-254-498-1.5-SC	BBP12, BP-PR+	R7950	1500	1
▲	B-498	<b>F</b> <b>R</b>	25.40	4.75	THT-253-498-3	BBP12, BP-PR+, IP, i7100, i5100	R4300, R7950	3000	1
▲	B-498	<b>F</b> <b>R</b>	25.40	4.75	THT-253-498-3-SC	BBP12, BP-PR+	R7950	3000	1



- F** Freezer environment
- N** Liquid nitrogen environment
- A** Autoclave environment
- H** Hot water bath (100°C)
- S** Self-laminating label
- L** Low-profile (extremely thin) label
- R** Removable

## STRAW AND ROD LABELS

Brady offers a range of labels designed to fit the small surface area of straws and rods and will withstand long-term storage.

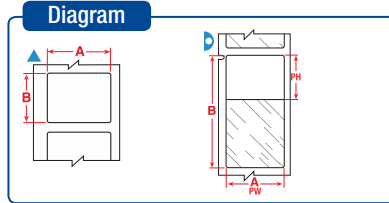

The background colours in the Order Reference column represent the material colour.

See page 42 for Brady's range of label printers.

Labels are shown per straw size and in order of label width.

Diagram	Material	Special Properties	Label Width A (mm)	Label Height B (mm)	Printable Area Width PW (mm)	Printable Area Height PH (mm)	Order Reference	Printer Compatibility	Printer Ribbon Series	Labels per Roll	Labels per Row
<b>0.25 ml Straw</b>											
▲	B-427	<b>FN S</b>	20.00	20.00	20.00	20.00	BPTLAB-35-427-YL	BBP12, BP-PR+	R7950	1000	1
▷	B-427	<b>FN S</b>	25.40	25.40	25.40	9.53	B33-211-427	BBP33	B30-R4300	3000	3
▷	B-427	<b>FN S</b>	25.40	25.40	25.40	9.53	B33-116-427	BBP33	B30-R4300	2500	2
▷	B-427	<b>FN S</b>	25.40	25.40	25.40	9.53	BM71-19-427	BMP61, BMP71	R4300	2500	1
▷	B-427	<b>FN S</b>	25.40	25.40	25.40	9.53	BPT-211-427	BBP12, BP-PR+	R7950	3000	3
▷	B-427	<b>FN S</b>	25.40	25.40	25.40	9.53	M-49-427	BMP51, BMP53	-	260	1
▷	B-461	<b>FNAHSL</b>	25.40	25.40	25.40	9.53	M71-19-461	BMP71	M71-R4300	250	1
▷	B-427	<b>FN S</b>	25.40	25.40	25.40	9.53	M71-19-427	BMP71	M71-R4300	250	1
▷	B-427	<b>FN S</b>	25.40	25.40	25.40	9.53	M71-19-427-YL	BMP71	M71-R4300	250	1
▷	B-427	<b>FN S</b>	25.40	25.40	25.40	9.53	PTL-19-427	BMP61, BMP71	R4310	250	1
▷	B-427	<b>FN S</b>	25.40	25.40	25.40	9.53	PTL-19-427-BL	BMP61, BMP71	R4310	250	1
▷	B-427	<b>FN S</b>	25.40	25.40	25.40	9.53	PTL-19-427-BR	BMP61, BMP71	R4310	250	1
▷	B-427	<b>FN S</b>	25.40	25.40	25.40	9.53	PTL-19-427-GR	BMP61, BMP71	R4310	250	1
▷	B-427	<b>FN S</b>	25.40	25.40	25.40	9.53	PTL-19-427-GY	BMP61, BMP71	R4310	250	1
▷	B-427	<b>FN S</b>	25.40	25.40	25.40	9.53	PTL-19-427-OR	BMP61, BMP71	R4310	250	1
▷	B-427	<b>FN S</b>	25.40	25.40	25.40	9.53	PTL-19-427-PL	BMP61, BMP71	R4310	250	1
▷	B-427	<b>FN S</b>	25.40	25.40	25.40	9.53	PTL-19-427-RD	BMP61, BMP71	R4310	250	1
▷	B-427	<b>FN S</b>	25.40	25.40	25.40	9.53	PTL-19-427-YL	BMP61, BMP71	R4310	250	1
▷	B-427	<b>FN S</b>	25.40	25.40	25.40	9.53	THT-116-427-5	BBP12, BP-PR+, IP, i7100, i5100	R4300, R7950	5000	2
▷	B-427	<b>FN S</b>	44.45	25.40	44.45	9.53	B33-120-427	BBP33	B30-R4300	1250	1
▷	B-427	<b>FN S</b>	44.45	25.40	44.45	9.53	M-133-427	BMP51, BMP53	-	140	1
▷	B-427	<b>FN S</b>	44.45	38.10	44.45	12.70	B33-121-427	BBP33	B30-R4300	1000	1
▷	B-427	<b>FN S</b>	44.45	38.10	44.45	12.70	M71-88-427	BMP71	M71-R4300	250	1
<b>0.50 ml Straw</b>											
▷	B-427	<b>FN S</b>	25.40	63.50	25.40	19.05	B33-511-427	BBP33	B30-R4300	1500	3
▷	B-427	<b>FN S</b>	25.40	63.50	25.40	19.05	BM71-21-427	BMP61, BMP71	R4300	1000	1
▷	B-427	<b>FN S</b>	25.40	63.50	25.40	19.05	BPT-511-427	BBP12, BP-PR+	R7950	3000	3
▷	B-427	<b>FN S</b>	25.40	63.50	25.40	19.05	M-51-427	BMP51, BMP53	-	110	1
▷	B-427	<b>FN S</b>	25.40	63.50	25.40	19.05	M71-21-427	BMP71	M71-R4300	100	1
▷	B-427	<b>FN S</b>	25.40	63.50	25.40	19.05	M71-21-427-YL	BMP71	M71-R4300	100	1
▷	B-427	<b>FN S</b>	25.40	63.50	25.40	19.05	PTL-21-427	BMP61, BMP71	R4310	100	1
▷	B-427	<b>FN S</b>	25.40	63.50	25.40	19.05	PTL-21-427-BL	BMP61, BMP71	R4310	100	1
▷	B-427	<b>FN S</b>	25.40	63.50	25.40	19.05	PTL-21-427-BR	BMP61, BMP71	R4310	100	1
▷	B-427	<b>FN S</b>	25.40	63.50	25.40	19.05	PTL-21-427-GR	BMP61, BMP71	R4310	100	1
▷	B-427	<b>FN S</b>	25.40	63.50	25.40	19.05	PTL-21-427-GY	BMP61, BMP71	R4310	100	1
▷	B-427	<b>FN S</b>	25.40	63.50	25.40	19.05	PTL-21-427-OR	BMP61, BMP71	R4310	100	1
▷	B-427	<b>FN S</b>	25.40	63.50	25.40	19.05	PTL-21-427-PL	BMP61, BMP71	R4310	100	1
▷	B-427	<b>FN S</b>	25.40	63.50	25.40	19.05	PTL-21-427-RD	BMP61, BMP71	R4310	100	1
▷	B-427	<b>FN S</b>	25.40	63.50	25.40	19.05	PTL-21-427-YL	BMP61, BMP71	R4310	100	1
▷	B-427	<b>FN S</b>	44.45	38.10	44.45	12.70	M-134-427	BMP51, BMP53	-	140	1
<b>Straw Rod</b>											
▲	B-427	<b>FN</b>	27.94	6.35	27.94	6.35	PTL-105-427-AW***	BMP61, BMP71	R4310	750	1
▷	B-461	<b>FNAHSL</b>	6.35	27.94	6.35	22.00	BPT-627-461*	BBP12, BP-PR+	R7950	1000	1
▲	B-427	<b>FN S</b>	27.94	6.35	27.94	6.35	M-135-427-AW**	BMP51, BMP53	-	240	1

\*Label is rotated 90° on liner. \*\*AW = All White / no transparent area.

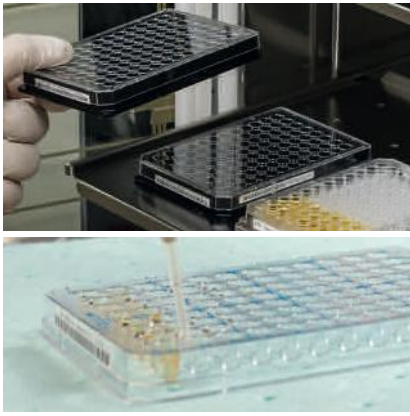

## WELL PLATE LABELS

When total tracking of all sample collections is required then Brady has a solution for Well plate identification. Our well plate labels guarantee crystal clear text and barcoding for most lab environments.

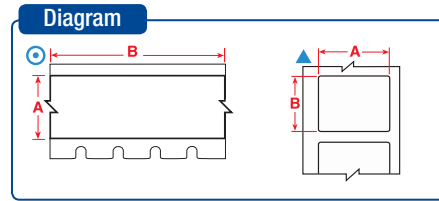

- F** Freezer environment
- N** Liquid nitrogen environment
- A** Autoclave environment
- H** Hot water bath (100°C)
- S** Self-laminating label
- L** Low-profile (extremely thin) label
- R** Removable

Labels are shown in order of label width.

The background colours in the Order Reference column represent the material colour.

See page 42 for Brady's range of label printers.

Diagram	Material	Special Properties	Label Width A (mm)	Label Height B (mm)	Label Length B (m)	Order Reference	Printer Compatibility	Printer Ribbon Series	Labels per Roll	Labels per Row
▲	B-488	<b>F A</b>	6.35	48.26	-	M-81-488	BMP51, BMP53	-	160	1
▲	B-423	<b>F A H</b>	6.35	50.80	-	M71-2-423	BMP71	M71-R6000HF	100	1
○	B-595	<b>F</b>	6.35	-	6.40	M21-250-595-WT	BMP21-LAB	-	1	1
○	B-595	<b>F</b>	6.35	-	6.40	M21-250-595-YL	BMP21-LAB	-	1	1
○	B-430	<b>F A H</b>	6.35	-	6.40	M21-250-430	BMP21-LAB	-	1	1
○	B-430	<b>F A H</b>	6.35	-	6.40	M21-250-430-WT-CL	BMP21-LAB	-	1	1
○	B-423	<b>F A H</b>	6.35	-	6.40	M21-250-423	BMP21-LAB	-	1	1
○	B-499	<b>F N A</b>	9.53	-	4.88	M21-375-499	BMP21-LAB	-	1	1
○	B-499	<b>F N A</b>	9.53	-	4.88	MC-375-499	BMP51, BMP53	-	1	1
○	B-7425	<b>F N A H</b>	9.53	-	6.40	M21-375-7425	BMP21-LAB	-	1	1
○	B-595	<b>F</b>	9.53	-	6.40	M21-375-595-BK	BMP21-LAB	-	1	1
○	B-595	<b>F</b>	9.53	-	6.40	M21-375-595-BL	BMP21-LAB	-	1	1
○	B-595	<b>F</b>	9.53	-	6.40	M21-375-595-GN	BMP21-LAB	-	1	1
○	B-595	<b>F</b>	9.53	-	6.40	M21-375-595-OR	BMP21-LAB	-	1	1
○	B-595	<b>F</b>	9.53	-	6.40	M21-375-595-RD	BMP21-LAB	-	1	1
○	B-595	<b>F</b>	9.53	-	6.40	M21-375-595-WT	BMP21-LAB	-	1	1
○	B-595	<b>F</b>	9.53	-	6.40	M21-375-595-YL	BMP21-LAB	-	1	1
○	B-488	<b>F A</b>	9.53	-	6.40	M21-375-488	BMP21-LAB	-	1	1
○	B-430	<b>F A H</b>	9.53	-	6.40	M21-375-430	BMP21-LAB	-	1	1
○	B-430	<b>F A H</b>	9.53	-	6.40	M21-375-430-WT-CL	BMP21-LAB	-	1	1
○	B-423	<b>F A H</b>	9.53	-	6.40	M21-375-423	BMP21-LAB	-	1	1
○	B-595	<b>F</b>	9.53	-	7.62	MC-375-595-WT-BK	BMP51, BMP53	-	1	1
○	B-595	<b>F</b>	9.53	-	7.62	MC-375-595-YL-BK	BMP51, BMP53	-	1	1
○	B-430	<b>F A H</b>	9.53	-	15.24	M71C-375-430	BMP71	M71-R6000HF	1	1
▲	B-423	<b>F A H</b>	12.70	12.70	-	BM71-7-423	BMP61, BMP71	R6000HF	5000	1
▲	B-423	<b>F A H</b>	12.70	12.70	-	M71-7-423	BMP71	M71-R6000HF	500	1
▲	B-423	<b>F A</b>	12.70	12.70	-	PTL-7-423	BMP61, BMP71	R6010	500	1
○	B-499	<b>F N A</b>	12.70	-	4.88	M21-500-499	BMP21-LAB	-	1	1
○	B-499	<b>F N A</b>	12.70	-	4.88	MC-500-499	BMP51, BMP53	-	1	1
○	B-595	<b>F</b>	12.70	-	6.10	MC-500-595-CL-BK	BMP51, BMP53	-	1	1
○	B-595	<b>F</b>	12.70	-	6.10	MC-500-595-CL-WT	BMP51, BMP53	-	1	1
○	B-7425	<b>F N A H</b>	12.70	-	6.40	M21-500-7425	BMP21-LAB	-	1	1
○	B-595	<b>F</b>	12.70	-	6.40	M21-500-595-BK	BMP21-LAB	-	1	1
○	B-595	<b>F</b>	12.70	-	6.40	M21-500-595-BL	BMP21-LAB	-	1	1
○	B-595	<b>F</b>	12.70	-	6.40	M21-500-595-GN	BMP21-LAB	-	1	1
○	B-595	<b>F</b>	12.70	-	6.40	M21-500-595-OR	BMP21-LAB	-	1	1
○	B-595	<b>F</b>	12.70	-	6.40	M21-500-595-RD	BMP21-LAB	-	1	1
○	B-595	<b>F</b>	12.70	-	6.40	M21-500-595-WT	BMP21-LAB	-	1	1
○	B-595	<b>F</b>	12.70	-	6.40	M21-500-595-YL	BMP21-LAB	-	1	1
○	B-488	<b>F A</b>	12.70	-	6.40	M21-500-488	BMP21-LAB	-	1	1
○	B-430	<b>F A H</b>	12.70	-	6.40	M21-500-430	BMP21-LAB	-	1	1
○	B-430	<b>F A H</b>	12.70	-	6.40	M21-500-430-WT-CL	BMP21-LAB	-	1	1
○	B-423	<b>F A H</b>	12.70	-	6.40	M21-500-423	BMP21-LAB	-	1	1
○	B-595	<b>F</b>	12.70	-	7.62	MC-500-595-BK-WT	BMP51, BMP53	-	1	1
○	B-595	<b>F</b>	12.70	-	7.62	MC-500-595-BL-WT	BMP51, BMP53	-	1	1
○	B-595	<b>F</b>	12.70	-	7.62	MC-500-595-GN-WT	BMP51, BMP53	-	1	1
○	B-595	<b>F</b>	12.70	-	7.62	MC-500-595-OR-BK	BMP51, BMP53	-	1	1
○	B-595	<b>F</b>	12.70	-	7.62	MC-500-595-RD-WT	BMP51, BMP53	-	1	1
○	B-595	<b>F</b>	12.70	-	7.62	MC-500-595-WT-BK	BMP51, BMP53	-	1	1
○	B-595	<b>F</b>	12.70	-	7.62	MC-500-595-WT-RD	BMP51, BMP53	-	1	1
○	B-595	<b>F</b>	12.70	-	7.62	MC-500-595-YL-BK	BMP51, BMP53	-	1	1
○	B-499	<b>F N A</b>	12.70	-	9.10	M71C-500-499	BMP71	M71-R4300	1	1

>>

## Diagram

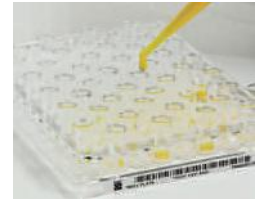
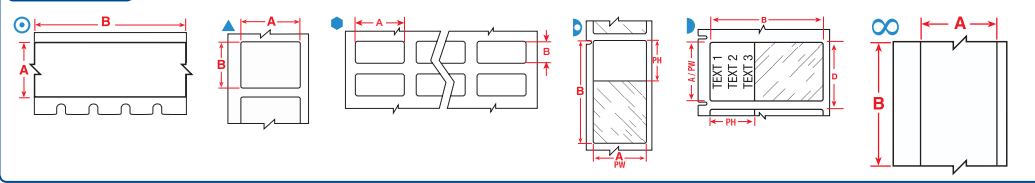
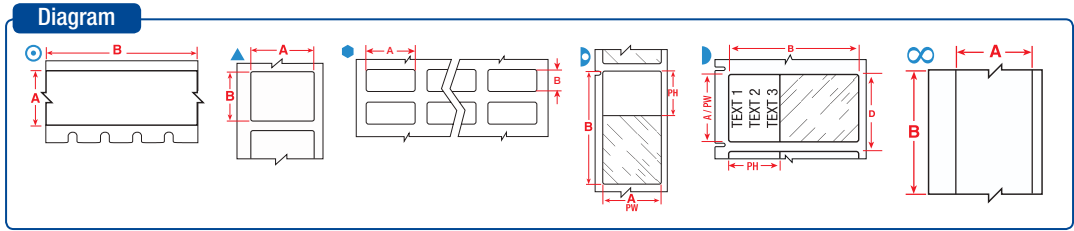
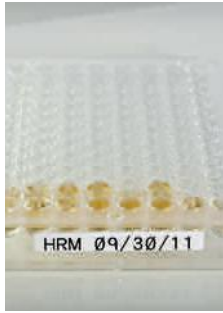

Diagram	Material	Special Properties	Label Width A (mm)	Label Height B (mm)	Label Length B (m)	Order Reference	Printer Compatibility	Printer Ribbon Series	Labels per Roll	Labels per Row
⊙	B-595	F	12.70	–	15.24	M71C-500-595-BK	BMP71	M71-R4400-WT	1	1
⊙	B-595	F	12.70	–	15.24	M71C-500-595-BL	BMP71	M71-R4400-WT	1	1
⊙	B-595	F	12.70	–	15.24	M71C-500-595-CL	BMP71	M71-R6000HF	1	1
⊙	B-595	F	12.70	–	15.24	M71C-500-595-GN	BMP71	M71-R4400-WT	1	1
⊙	B-595	F	12.70	–	15.24	M71C-500-595-OR	BMP71	M71-R6000HF	1	1
⊙	B-595	F	12.70	–	15.24	M71C-500-595-RD	BMP71	M71-R4400-WT	1	1
⊙	B-595	F	12.70	–	15.24	M71C-500-595-WT	BMP71	M71-R6000HF	1	1
⊙	B-595	F	12.70	–	15.24	M71C-500-595-YL	BMP71	M71-R6000HF	1	1
⊙	B-430	F AH	12.70	–	15.24	M71C-500-430	BMP71	M71-R6000HF	1	1
∞	B-430	F AH	12.70	–	15.24	PTL-8-430	BMP61, BMP71	R6010	1	1
∞	B-595	F	12.70	–	30.40	B30C-500-595-BK	BBP33	B30-R10000-WT	1	1
∞	B-595	F	12.70	–	30.40	B30C-500-595-BL	BBP33	B30-R10000-WT	1	1
∞	B-595	F	12.70	–	30.40	B30C-500-595-CL	BBP33	B30-R10000	1	1
∞	B-595	F	12.70	–	30.40	B30C-500-595-GN	BBP33	B30-R10000-WT	1	1
∞	B-595	F	12.70	–	30.40	B30C-500-595-OR	BBP33	B30-R10000	1	1
∞	B-595	F	12.70	–	30.40	B30C-500-595-RD	BBP33	B30-R10000-WT	1	1
∞	B-595	F	12.70	–	30.40	B30C-500-595-WT	BBP33	B30-R10000	1	1
∞	B-595	F	12.70	–	30.40	B30C-500-595-YL	BBP33	B30-R10000	1	1
▷	B-461	F N A H S L	15.24	41.28	–	PTL-76-461	BMP61, BMP71	R4310	250	1
●	B-8423	F A	19.05	6.35	–	BPT-1-8423-2.5	BBP12, BP-PR+	R6000HF	2500	5
▷	B-427	F N S	19.05	38.10	–	BM71-30-427	BMP61, BMP71	R4300	2500	1
▷	B-427	F N S	19.05	38.10	–	M-90-427	BMP51, BMP53	–	180	1
▷	B-427	F N S	19.05	38.10	–	M71-30-427	BMP71	M71-R4300	250	1
⊙	B-499	F N A	19.05	–	4.88	M21-750-499	BMP21-LAB	–	1	1
⊙	B-499	F N A	19.05	–	4.88	MC-750-499	BMP51, BMP53	–	1	1
⊙	B-595	F	19.05	–	6.10	MC-750-595-CL-BK	BMP51, BMP53	–	1	1
⊙	B-595	F	19.05	–	6.10	MC-750-595-CL-WT	BMP51, BMP53	–	1	1
⊙	B-7425	F N A H	19.05	–	6.40	M21-750-7425	BMP21-LAB	–	1	1
⊙	B-595	F	19.05	–	6.40	M21-750-595-BK	BMP21-LAB	–	1	1
⊙	B-595	F	19.05	–	6.40	M21-750-595-BL	BMP21-LAB	–	1	1
⊙	B-595	F	19.05	–	6.40	M21-750-595-GN	BMP21-LAB	–	1	1
⊙	B-595	F	19.05	–	6.40	M21-750-595-OR	BMP21-LAB	–	1	1
⊙	B-595	F	19.05	–	6.40	M21-750-595-RD	BMP21-LAB	–	1	1
⊙	B-595	F	19.05	–	6.40	M21-750-595-WT	BMP21-LAB	–	1	1
⊙	B-595	F	19.05	–	6.40	M21-750-595-YL	BMP21-LAB	–	1	1
⊙	B-488	F A	19.05	–	6.40	M21-750-488	BMP21-LAB	–	1	1
⊙	B-430	F AH	19.05	–	6.40	M21-750-430	BMP21-LAB	–	1	1
⊙	B-430	F AH	19.05	–	6.40	M21-750-430-WT-CL	BMP21-LAB	–	1	1
⊙	B-423	F AH	19.05	–	6.40	M21-750-423	BMP21-LAB	–	1	1
⊙	B-595	F	19.05	–	7.62	MC-750-595-BK-WT	BMP51, BMP53	–	1	1
⊙	B-595	F	19.05	–	7.62	MC-750-595-BL-WT	BMP51, BMP53	–	1	1
⊙	B-595	F	19.05	–	7.62	MC-750-595-GN-WT	BMP51, BMP53	–	1	1
⊙	B-595	F	19.05	–	7.62	MC-750-595-OR-BK	BMP51, BMP53	–	1	1
⊙	B-595	F	19.05	–	7.62	MC-750-595-RD-WT	BMP51, BMP53	–	1	1
⊙	B-595	F	19.05	–	7.62	MC-750-595-WT-BK	BMP51, BMP53	–	1	1
⊙	B-595	F	19.05	–	7.62	MC-750-595-WT-RD	BMP51, BMP53	–	1	1
⊙	B-595	F	19.05	–	7.62	MC-750-595-YL-BK	BMP51, BMP53	–	1	1
●	B-498	F R	20.32	36.50	–	B33-95-498	BBP33	B30-R6200	2300	3
●	B-498	F R	20.32	36.50	–	THT-95-498-5	BBP12, BP-PR+, IP, i7100, i5100	R4300, R7950	5000	3
▲	B-499	F N A	22.86	12.70	–	M71-84-499	BMP71	M71-R4300	500	1
●	B-488	F A	22.86	19.05	–	B33-616-488	BBP33	B30-R4300	3000	3
●	B-488	F A	22.86	22.86	–	B33-617-488	BBP33	B30-R4300	3000	3
▲	B-423	F A	25.40	76.2	–	PTL-22-423	BMP61, BMP71	R6010	100	1
▲	B-423	F AH	25.40	4.75	–	M71-14-423	BMP71	M71-R6000HF	750	1
▲	B-423	F A	25.40	4.75	–	PTL-14-423	BMP61, BMP71	R6010	750	1
●	B-423	F AH	25.40	4.75	–	THT-41-423-10	BBP12, BP-PR+, IP, i7100, i5100	R6000HF	10000	3
●	B-423	F AH	25.40	6.35	–	THT-51-423-10	BBP12, BP-PR+, IP, i7100, i5100	R6000HF	10000	3
▲	B-423	F AH	25.40	6.99	–	M71-15-423	BMP71	M71-R6000HF	750	1
▲	B-423	F A	25.40	6.99	–	PTL-15-423	BMP61, BMP71	R6010	750	1
●	B-499	F N A	25.40	9.53	–	B33-152-499	BBP33	B30-R6000HF	1500	2
●	B-499	F N A	25.40	9.53	–	THT-152-499-3	BBP12, BP-PR+, IP, i7100, i5100	R4900	3000	2
●	B-499	F N A	25.40	9.53	–	THT-152-499-1.5-SC	BBP12, BP-PR+	R7950	1500	2

>>

F Freezer environment N Liquid nitrogen environment A Autoclave environment H Hot water bath (100°C) S Self-laminating label L Low-profile (extremely thin) label R Removable

# Well Plate Labels



Labels are shown in order of label width.

The background colours in the Order Reference column represent the material colour.

See page 42 for Brady's range of label printers.

Diagram	Material	Special Properties	Label Width A (mm)	Label Height B (mm)	Label Length B (m)	Order Reference	Printer Compatibility	Printer Ribbon Series	Labels per Roll	Labels per Row
⊙	B-425	<b>F</b>	25.40	9.98	—	THT-30-425-10	BBP12, BP-PR+, IP, i7100, i5100	R6400	10000	3
▲	B-432	<b>F A</b>	25.40	12.70	—	M-17-432-CL-BK	BMP51, BMP53	—	280	1
▲	B-498	<b>F R</b>	25.40	12.70	—	M71-17-498	BMP71	M71-R6200	500	1
▲	B-430	<b>F A H</b>	25.40	12.70	—	M71-17-430	BMP71	M71-R6000HF	500	1
▲	B-423	<b>F A H</b>	25.40	12.70	—	M71-17-423	BMP71	M71-R6000HF	500	1
▲	B-498	<b>F R</b>	25.40	12.70	—	PTL-17-498	BMP61, BMP71	R6210	500	1
▲	B-430	<b>F A H</b>	25.40	12.70	—	PTL-17-430	BMP61, BMP71	R6010	500	1
▲	B-423	<b>F A</b>	25.40	12.70	—	PTL-17-423	BMP61, BMP71	R6010	500	1
⊙	B-430	<b>F A H</b>	25.40	12.70	—	THT-39-430-10	BBP12, BP-PR+, IP, i7100, i5100	R6000HF	10000	3
⊙	B-498	<b>F R</b>	25.40	36.50	—	BPT-621-498	BBP12, BP-PR+	R7950	3000	3
⊙	B-498	<b>F R</b>	25.40	36.50	—	THT-89-498-5	BBP12, BP-PR+, IP, i7100, i5100	R4300, R7950	5000	3
▷	B-427	<b>F N S</b>	25.40	38.10	—	BM71-31-427	BMP61, BMP71	R4300	2500	1
▷	B-427	<b>F N S</b>	25.40	38.10	—	M-91-427	BMP51, BMP53	—	180	1
▷	B-461	<b>F N A H S L</b>	25.40	38.10	—	M71-31-461	BMP71	M71-R6200	250	1
▷	B-427	<b>F N S</b>	25.40	38.10	—	M71-31-427	BMP71	M71-R4300	250	1
▲	B-423	<b>F A H</b>	25.40	50.80	—	BM71-20-423	BMP61, BMP71	R6000HF	1000	1
▲	B-423	<b>F A H</b>	25.40	50.80	—	M71-20-423	BMP71	M71-R6000HF	100	1
▲	B-423	<b>F A H</b>	25.40	76.20	—	M71-22-423	BMP71	M71-R6000HF	100	1
⊙	B-499	<b>F N A</b>	25.40	—	4.88	MC-1000-499	BMP51, BMP53	—	1	1
⊙	B-595	<b>F</b>	25.40	—	6.10	MC1-1000-595-CL-BK	BMP51, BMP53	—	1	1
⊙	B-595	<b>F</b>	25.40	—	6.10	MC1-1000-595-CL-WT	BMP51, BMP53	—	1	1
⊙	B-595	<b>F</b>	25.40	—	7.62	MC1-1000-595-BK-WT	BMP51, BMP53	—	1	1
⊙	B-595	<b>F</b>	25.40	—	7.62	MC1-1000-595-BL-WT	BMP51, BMP53	—	1	1
⊙	B-595	<b>F</b>	25.40	—	7.62	MC1-1000-595-GN-WT	BMP51, BMP53	—	1	1
⊙	B-595	<b>F</b>	25.40	—	7.62	MC1-1000-595-OR-BK	BMP51, BMP53	—	1	1
⊙	B-595	<b>F</b>	25.40	—	7.62	MC1-1000-595-RD-WT	BMP51, BMP53	—	1	1
⊙	B-595	<b>F</b>	25.40	—	7.62	MC1-1000-595-WT-BK	BMP51, BMP53	—	1	1
⊙	B-595	<b>F</b>	25.40	—	7.62	MC1-1000-595-WT-RD	BMP51, BMP53	—	1	1
⊙	B-595	<b>F</b>	25.40	—	7.62	MC1-1000-595-YL-BK	BMP51, BMP53	—	1	1
⊙	B-499	<b>F N A</b>	25.40	—	9.10	M71C-1000-499	BMP71	M71-R4300	1	1
⊙	B-595	<b>F</b>	25.40	—	15.24	M71C-1000-595-BK	BMP71	M71-R4400-WT	1	1
⊙	B-595	<b>F</b>	25.40	—	15.24	M71C-1000-595-BL	BMP71	M71-R4400-WT	1	1
⊙	B-595	<b>F</b>	25.40	—	15.24	M71C-1000-595-CL	BMP71	M71-R6000HF	1	1
⊙	B-595	<b>F</b>	25.40	—	15.24	M71C-1000-595-GN	BMP71	M71-R4400-WT	1	1
⊙	B-595	<b>F</b>	25.40	—	15.24	M71C-1000-595-OR	BMP71	M71-R6000HF	1	1
⊙	B-595	<b>F</b>	25.40	—	15.24	M71C-1000-595-RD	BMP71	M71-R4400-WT	1	1
⊙	B-595	<b>F</b>	25.40	—	15.24	M71C-1000-595-WT	BMP71	M71-R6000HF	1	1
⊙	B-595	<b>F</b>	25.40	—	15.24	M71C-1000-595-YL	BMP71	M71-R6000HF	1	1
⊙	B-430	<b>F A H</b>	25.40	—	15.24	M71C-1000-430	BMP71	M71-R6000HF	1	1
∞	B-439	<b>F</b>	25.40	—	15.24	PTL-42-439	BMP61, BMP71	R6010	1	1
∞	B-439	<b>F</b>	25.40	—	15.24	PTL-42-439-OR	BMP61, BMP71	R6010	1	1
∞	B-439	<b>F</b>	25.40	—	15.24	PTL-42-439-RD	BMP61, BMP71	R6010	1	1
∞	B-439	<b>F</b>	25.40	—	15.24	PTL-42-439-YL	BMP61, BMP71	R6010	1	1
⊙	B-423	<b>F A H</b>	27.94	9.65	—	THT-31-423-10	BBP12, BP-PR+, IP, i7100, i5100	R6000HF	10000	2
▲	B-498	<b>F R</b>	38.10	12.70	—	BM71-29-498	BMP61, BMP71	R6200	5000	1
▲	B-499	<b>F N A</b>	38.10	12.70	—	M71-29-499	BMP71	M71-R4300	500	1
▲	B-498	<b>F R</b>	38.10	12.70	—	M71-29-498	BMP71	M71-R6200	500	1
▲	B-499	<b>F N A</b>	38.10	12.70	—	PTL-29-499	BMP61, BMP71	R4310	500	1
▲	B-498	<b>F R</b>	38.10	12.70	—	PTL-29-498	BMP61, BMP71	R6210	500	1
⊙	B-423	<b>F A H</b>	38.10	12.70	—	THT-37-423-10	BBP12, BP-PR+, IP, i7100, i5100	R6000HF	10000	2
▲	B-499	<b>F N A</b>	38.10	19.05	—	B33-136-499	BBP33	B30-R6000HF	1500	1
⊙	B-8423	<b>F A</b>	38.10	19.05	—	BPT-6-8423-2.5	BBP12, BP-PR+	R6000HF	2500	2
▲	B-499	<b>F N A</b>	38.10	19.05	—	M71-30-499	BMP71	M71-R4300	250	1
▲	B-427	<b>F N S</b>	38.10	19.05	—	M71-30-427-AW**	BMP71	M71-R4300	250	1
▲	B-499	<b>F N A</b>	38.10	19.05	—	PTL-30-499	BMP61, BMP71	R4310	250	1
▲	B-427	<b>F N</b>	38.10	19.05	—	PTL-30-427-AW***	BMP61, BMP71	R4310	250	1

\*\*AW = All White / no transparent area.

>>

**F** Freezer environment **N** Liquid nitrogen environment **A** Autoclave environment **H** Hot water bath (100°C) **S** Self-laminating label **L** Low-profile (extremely thin) label **R** Removable

## Diagram

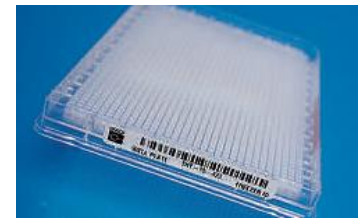
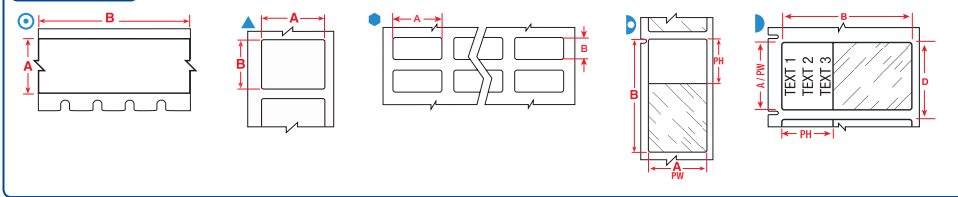

Labels are shown in order of label width.

The background colours in the Order Reference column represent the material colour.

See page 42 for Brady's range of label printers.

Diagram	Material	Special Properties	Label Width A (mm)	Label Height B (mm)	Label Length B (m)	Order Reference	Printer Compatibility	Printer Ribbon Series	Labels per Roll	Labels per Row
▲	B-499	FNA	38.10	19.05	-	TH1-136-499-3	BBP12, BP-PR+, IP, i7100, i5100	R4900	3000	1
▲	B-499	FNA	38.10	19.05	-	TH1-136-499-1.5-SC	BBP12, BP-PR+	R7950	1500	1
▲	B-499	FNA	38.10	25.40	-	M71-31-499	BMP71	M71-R4300	250	1
▲	B-498	FNA R	38.10	25.40	-	M71-31-498	BMP71	M71-R6200	250	1
▲	B-423	F AH	38.10	25.40	-	M71-31-423	BMP71	M71-R6000HF	250	1
▲	B-499	FNA	38.10	25.40	-	PTL-31-499	BMP61, BMP71	R4310	250	1
▲	B-498	FNA R	38.10	25.40	-	PTL-31-498	BMP61, BMP71	R6210	250	1
▲	B-423	FNA	38.10	25.40	-	PTL-31-423	BMP61, BMP71	R6010	250	1
▷	B-461	FNAHSL	38.10	88.90	-	PTL-77-461	BMP61, BMP71	R4310	100	1
▲	B-490	FNAHL	38.10	98.43	-	PTL-114-490	BMP61, BMP71	R4310	100	1
▲	B-488	FNA	48.26	6.35	-	B33-635-488	BBP33	B30-R4300	2000	1
▲	B-488	FNA	48.26	6.35	-	BPT-635-488	BBP12, BP-PR+	R7950	2000	1
▲	B-499	FNA	48.26	6.35	-	M71-81-499	BMP71	M71-R4300	750	1
▲	B-488	FNA	48.26	6.35	-	M71-81-488	BMP71	M71-R4300	750	1
▲	B-499	FNA	48.26	6.35	-	PTL-81-499	BMP61, BMP71	R4310	750	1
▲	B-488	FNA	48.26	6.35	-	PTL-81-488	BMP61, BMP71	R4310	750	1
▲	B-499	FNA	48.26	25.40	-	M71-78-499	BMP71	M71-R4300	250	1
▲	B-499	FNA	48.26	25.40	-	PTL-78-499	BMP61, BMP71	R4310	250	1
▲	B-488	FNA	48.26	25.40	-	PTL-78-488	BMP61, BMP71	R4310	250	1
▲	B-427	FNA	48.26	25.40	-	PTL-78-427-AW***	BMP61, BMP71	R4310	250	1
○	B-499	FNA	48.26	-	9.10	M71C-1900-499	BMP71	M71-R4300	1	1
○	B-430	FNAH	48.26	-	15.24	M71C-1900-430	BMP71	M71-R6000HF	1	1
▲	B-499	FNA	50.80	6.35	-	B33-151-499	BBP33	B30-R6000HF	1500	1
▲	B-423	FNA	50.80	6.35	-	PTL-2-423	BMP61, BMP71	R6010	100	1
▲	B-499	FNA	50.80	6.35	-	TH1-151-499-3	BBP12, BP-PR+, IP, i7100, i5100	R4900	3000	1
▲	B-499	FNA	50.80	6.35	-	TH1-151-499-1.5-SC	BBP12, BP-PR+	R7950	1500	1
▲	B-423	FNAH	50.80	6.35	-	TH1-15-423-2.5	BBP12, BP-PR+, IP, i7100, i5100	R6000HF	2500	1
▲	B-423	FNA	50.80	25.40	-	PTL-20-423	BMP61, BMP71	R6010	100	1
▲	B-490	FNAHL	55.88	38.10	-	PTL-113-490	BMP61, BMP71	R4310	100	1
▲	B-423	FNAH	63.50	5.08	-	TH1-142-423-2.5	BBP12, BP-PR+, IP, i7100, i5100	R6000HF	2500	1
▲	B-430	FNAH	76.20	25.40	-	TH1-18-430-3	BBP12, BP-PR+, IP, i7100, i5100	R6000HF	3000	1
▲	B-430	FNAH	76.20	50.80	-	TH1-19-430-1	BBP12, BP-PR+, IP, i7100, i5100	R6000HF	1000	1

\*\*\*AW = All White / no transparent area.



## Part number explanation

Most Brady references for printable labels follow the same three-part format: The first code indicates the technology, the second part is a number indicating the label size (where applicable) and the third part indicates the Brady material (where applicable).

# M71-73-461

BMP71 Technology      Label size code      Material (B-number)





## BOTTLES / FLASKS & DISHES

Brady's labels for bottles, flasks and dishes are easy to handle and flexible. This enables the labels to be placed on curved containers and remain attached and legible, even after being subjected to freezing, liquid nitrogen and heat.

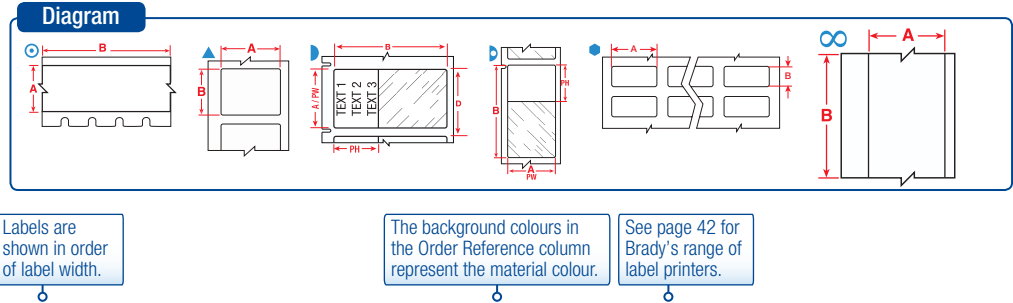

Diagram	Material	Special Properties	Label Width A (mm)	Label Height B (mm)	Label Length B (m)	Printable Area Width PW (mm)	Printable Area Height PH (mm)	Order Reference	Printer Compatibility	Printer Ribbon Series	Labels per Roll	Labels per Row
⊙	B-430	F AH	6.35	-	6.40	-	-	M21-250-430	BMP21-LAB	-	1	1
⊙	B-430	F AH	6.35	-	6.40	-	-	M21-250-430-WT-CL	BMP21-LAB	-	1	1
⊙	B-423	F AH	6.35	-	6.40	-	-	M21-250-423	BMP21-LAB	-	1	1
▲	B-499	F NA	9.53	20.96	-	-	-	M-130-499	BMP51, BMP53	-	220	1
⊙	B-499	F NA	9.53	-	4.88	-	-	M21-375-499	BMP21-LAB	-	1	1
⊙	B-499	F NA	9.53	-	4.88	-	-	MC-375-499	BMP51, BMP53	-	1	1
⊙	B-430	F AH	9.53	-	6.40	-	-	M21-375-430	BMP21-LAB	-	1	1
⊙	B-430	F AH	9.53	-	6.40	-	-	M21-375-430-WT-CL	BMP21-LAB	-	1	1
⊙	B-430	F AH	9.53	-	15.24	-	-	M71C-375-430	BMP71	M71-R6000HF	1	1
▲	B-499	F NA	12.70	12.70	-	12.70	12.70	PTL-7-499	BMP61, BMP71	R4310	500	1
▲	B-498	F R	12.70	12.70	-	12.70	12.70	PTL-7-498	BMP61, BMP71	R6210	500	1
▲	B-423	F AH	12.70	12.70	-	-	-	BM71-7-423	BMP61, BMP71	R6000HF	5000	1
▲	B-423	F AH	12.70	12.70	-	-	-	M71-7-423	BMP71	M71-R6000HF	500	1
▲	B-423	F A	12.70	12.70	-	-	-	PTL-7-423	BMP61, BMP71	R6010	500	1
●	B-499	F NA	12.70	19.05	-	-	-	B33-68-499	BBP33	B30-R6000HF	1500	4
●	B-499	F NA	12.70	19.05	-	-	-	THT-68-499-10	BBP12, BP-PR+, IP, i7100, i5100	R4900	10000	4
▲	B-499	F NA	12.70	25.40	-	-	-	M-131-499	BMP51, BMP53	-	180	1
▲	B-498	F R	12.70	25.40	-	-	-	M-131-498	BMP51, BMP53	-	180	1
⊙	B-499	F NA	12.70	-	4.88	-	-	M21-500-499	BMP21-LAB	-	1	1
⊙	B-499	F NA	12.70	-	4.88	-	-	MC-500-499	BMP51, BMP53	-	1	1
⊙	B-430	F AH	12.70	-	6.40	-	-	M21-500-430	BMP21-LAB	-	1	1
⊙	B-430	F AH	12.70	-	6.40	-	-	M21-500-430-WT-CL	BMP21-LAB	-	1	1
⊙	B-499	F NA	12.70	-	9.10	-	-	M71C-500-499	BMP71	M71-R4300	1	1
∞	B-430	F AH	12.70	-	15.24	12.70	152.4	PTL-8-430	BMP61, BMP71	R6010	1	1
⊙	B-430	F AH	12.70	-	15.24	-	-	M71C-500-430	BMP71	M71-R6000HF	1	1
▲	B-432	F A	19.05	12.70	-	-	-	PTL-11-432	BMP61, BMP71	R6010	500	1
▶	B-427	F N S	19.05	38.10	-	19.05	12.70	BM71-30-427	BMP61, BMP71	R4300	2500	1
▶	B-427	F N S	19.05	38.10	-	19.05	12.70	M-90-427	BMP51, BMP53	-	180	1
▶	B-427	F N S	19.05	38.10	-	19.05	12.70	M71-30-427	BMP71	M71-R4300	250	1
⊙	B-499	F NA	19.05	-	4.88	-	-	M21-750-499	BMP21-LAB	-	1	1
⊙	B-499	F NA	19.05	-	4.88	-	-	MC-750-499	BMP51, BMP53	-	1	1
⊙	B-430	F AH	19.05	-	6.40	-	-	M21-750-430	BMP21-LAB	-	1	1
⊙	B-430	F AH	19.05	-	6.40	-	-	M21-750-430-WT-CL	BMP21-LAB	-	1	1
▲	B-427	F N S	20.00	20.00	-	20.00	20.00	BPTLAB-35-427-YL	BBP12, BP-PR+, IP	R7950	1000	1
▲	B-499	F NA	22.86	12.70	-	-	-	B33-125-499	BBP33	B30-R6000HF	1500	1
▲	B-499	F NA	22.86	12.70	-	-	-	PTL-84-499	BMP61, BMP71	R4310	500	1
▲	B-499	F NA	22.86	12.70	-	-	-	THT-125-499-3	BBP12, BP-PR+, IP, i7100, i5100	R4900	3000	1
▲	B-499	F NA	22.86	12.70	-	-	-	THT-125-499-1.5-SC	BBP12, BP-PR+, IP	R7950	1500	1
●	B-488	F A	22.86	19.05	-	-	-	B33-616-488	BBP33	B30-R4300	3000	3
●	B-488	F A	22.86	19.05	-	-	-	THT-140-488-3	BBP12, BP-PR+, IP, i7100, i5100	R4300, R7950	3000	2
●	B-488	F A	22.86	19.05	-	-	-	THT-140-488-1.5-SC	BBP12, BP-PR+, IP	R7950	1500	2
▲	B-488	F A	22.86	22.86	-	-	-	B33-617-488	BBP33	B30-R4300	3000	3
▲	B-488	F A	22.86	22.86	-	-	-	THT-164-488-1-SC	BBP12, BP-PR+, IP	R7950	1000	1
●	B-488	F A	22.86	22.86	-	-	-	THT-141-488-3	BBP12, BP-PR+, IP, i7100, i5100	R4300, R7950	3000	2
▲	B-423	F A	25.4	76.2	-	-	-	PTL-22-423	BMP61, BMP71	R6010	100	1
▲	B-423	F AH	25.40	4.75	-	-	-	M71-14-423	BMP71	M71-R6000HF	750	1
▲	B-423	F A	25.40	4.75	-	-	-	PTL-14-423	BMP61, BMP71	R6010	750	1
●	B-423	F AH	25.40	4.75	-	-	-	THT-41-423-10	BBP12, BP-PR+, IP, i7100, i5100	R6000HF	10000	3
●	B-423	F AH	25.40	6.35	-	-	-	THT-51-423-10	BBP12, BP-PR+, IP, i7100, i5100	R6000HF	10000	3
▲	B-423	F AH	25.40	6.99	-	-	-	M71-15-423	BMP71	M71-R6000HF	750	1
▲	B-423	F A	25.40	6.99	-	-	-	PTL-15-423	BMP61, BMP71	R6010	750	1
●	B-499	F NA	25.40	9.53	-	-	-	B33-152-499	BBP33	B30-R6000HF	1500	2

>>

F Freezer environment N Liquid nitrogen environment A Autoclave environment H Hot water bath (100°C) S Self-laminating label L Low-profile (extremely thin) label R Removable

# Bottles / Flasks & Dishes

## Diagram

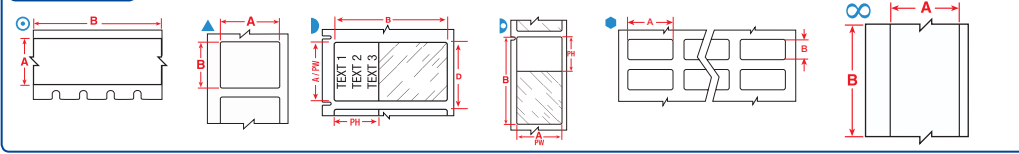

Labels are shown in order of label width.

The background colours in the Order Reference column represent the material colour.

See page 42 for Brady's range of label printers.

Diagram	Material	Special Properties	Label Width A (mm)	Label Height B (mm)	Label Length B (m)	Printable Area Width PW (mm)	Printable Area Height PH (mm)	Order Reference	Printer Compatibility	Printer Ribbon Series	Labels per Roll	Labels per Row
⊙	B-499	FNA	25.40	9.53	-	-	-	THT-152-499-3	BBP12, BP-PR+, IP, i7100, i5100	R4900	3000	2
⊙	B-499	FNA	25.40	9.53	-	-	-	THT-152-499-1.5-SC	BBP12, BP-PR+, IP	R7950	1500	2
⊙	B-425	F	25.40	9.98	-	-	-	THT-30-425-10	BBP12, BP-PR+, IP, i7100, i5100	R6400	10000	3
▲	B-498	F	25.40	12.70	-	25.40	12.70	PTL-17-498	BMP61, BMP71	R6210	500	1
⊙	B-423	F AH	25.40	12.70	-	-	-	B33-5-423	BBP33	B30-R6000HF	5000	3
▲	B-498	F	25.40	12.70	-	-	-	M71-17-498	BMP71	M71-R6200	500	1
▲	B-423	F AH	25.40	12.70	-	-	-	M71-17-423	BMP71	M71-R6000HF	500	1
▲	B-7351	F	25.40	12.70	-	-	-	PTL-17-7351	BMP61, BMP71	R6000HF	500	1
▲	B-432	F A	25.40	12.70	-	-	-	PTL-17-432	BMP61, BMP71	R6010	500	1
▲	B-430	F AH	25.40	12.70	-	-	-	PTL-17-430	BMP61, BMP71	R6010	500	1
▲	B-423	F A	25.40	12.70	-	-	-	PTL-17-423	BMP61, BMP71	R6010	500	1
▲	B-533	F A	25.40	12.70	-	-	-	THT-59-533-10	BBP12, BP-PR+, IP, i7100, i5100	R6000HF	10000	1
▲	B-498	F	25.40	12.70	-	-	-	THT-59-498-10	BBP12, BP-PR+, IP, i7100, i5100	R4300, R7950	10000	1
▲	B-498	F	25.40	12.70	-	-	-	THT-59-498-2.5-SC	BBP12, BP-PR+, IP	R7950	2500	1
⊙	B-430	F AH	25.40	12.70	-	-	-	THT-39-430-10	BBP12, BP-PR+, IP, i7100, i5100	R6000HF	10000	3
⊙	B-488	F A	25.40	12.70	-	-	-	THT-5-488-10	BBP12, BP-PR+, IP, i7100, i5100	R4300, R7950	10000	3
⊙	B-492	FN H L	25.40	19.05	-	-	-	THT-88-492-5	BBP12, BP-PR+, IP, i7100, i5100	R6400	5000	2
▲	B-499	FNA	25.40	25.40	-	-	-	M71-19-499	BMP71	M71-R4300	250	1
▲	B-492	FN H L	25.40	25.40	-	-	-	M71-19-492	BMP71	M71-R6400	250	1
▲	B-498	F	25.40	31.75	-	-	-	M-103-498	BMP51, BMP53	-	160	1
▷	B-427	FN S	25.40	38.10	-	25.40	12.70	BM71-31-427	BMP61, BMP71	R4300	2500	1
▷	B-427	FN S	25.40	38.10	-	25.40	12.70	M-91-427	BMP51, BMP53	-	180	1
▷	B-427	FN S	25.40	38.10	-	25.40	12.70	M71-31-427	BMP71	M71-R4300	250	1
▲	B-498	F	25.40	48.26	-	-	-	M-128-498	BMP51, BMP53	-	100	1
▲	B-423	F AH	25.40	50.80	-	-	-	BM71-20-423	BMP61, BMP71	R6000HF	1000	1
▲	B-423	F AH	25.40	50.80	-	-	-	M71-20-423	BMP71	M71-R6000HF	100	1
▷	B-427	FN S	25.40	63.50	-	25.40	19.05	PTL-21-427	BMP61, BMP71	R4310	100	1
▲	B-423	F AH	25.40	76.20	-	-	-	M71-22-423	BMP71	M71-R6000HF	100	1
⊙	B-499	FNA	25.40	-	4.88	-	-	MC-1000-499	BMP51, BMP53	-	1	1
⊙	B-499	FNA	25.40	-	9.10	-	-	M71C-1000-499	BMP71	M71-R4300	1	1
⊙	B-430	F AH	25.40	-	15.24	-	-	M71C-1000-430	BMP71	M71-R6000HF	1	1
∞	B-439	F	25.40	-	15.24	-	-	PTL-42-439	BMP61, BMP71	R6010	1	1
∞	B-439	F	25.40	-	15.24	-	-	PTL-42-439-OR	BMP61, BMP71	R6010	1	1
∞	B-439	F	25.40	-	15.24	-	-	PTL-42-439-RD	BMP61, BMP71	R6010	1	1
∞	B-439	F	25.40	-	15.24	-	-	PTL-42-439-YL	BMP61, BMP71	R6010	1	1
▲	B-498	F	26.67	6.35	-	-	-	THT-199-498-3	BBP12, BP-PR+, IP, i7100, i5100	R4300, R7950	3000	1
▲	B-498	F	26.67	6.35	-	-	-	THT-199-498-3-SC	BBP12, BP-PR+, IP	R7950	3000	1
▲	B-423	F AH	31.75	69.85	-	-	-	M71-26-423	BMP71	M71-R6000HF	100	1
▲	B-499	FNA	38.10	12.70	-	-	-	M71-29-499	BMP71	M71-R4300	500	1
▲	B-499	FNA	38.10	12.70	-	-	-	PTL-29-499	BMP61, BMP71	R4310	500	1
▲	B-498	F	38.10	12.70	-	-	-	PTL-29-498	BMP61, BMP71	R6210	500	1
▲	B-427	FN S	38.10	19.05	-	38.10	19.05	M71-30-427-AW**	BMP71	M71-R4300	250	1
▲	B-427	FN	38.10	19.05	-	38.10	19.05	PTL-30-427-AW***	BMP61, BMP71	R4310	250	1
▲	B-499	FNA	38.10	19.05	-	-	-	B33-136-499	BBP33	B30-R6000HF	1500	1
⊙	B-8423	F A	38.10	19.05	-	-	-	B33-6-8423	BBP33	B30-R6000HF	2500	2
▲	B-499	FNA	38.10	19.05	-	-	-	M71-30-499	BMP71	M71-R4300	250	1
▲	B-499	FNA	38.10	19.05	-	-	-	PTL-30-499	BMP61, BMP71	R4310	250	1
▲	B-499	FNA	38.10	19.05	-	-	-	THT-136-499-3	BBP12, BP-PR+, IP, i7100, i5100	R4900	3000	1
▲	B-499	FNA	38.10	19.05	-	-	-	THT-136-499-1.5-SC	BBP12, BP-PR+, IP	R7950	1500	1
▲	B-499	FNA	38.10	25.40	-	-	-	M71-31-499	BMP71	M71-R4300	250	1
▲	B-423	F AH	38.10	25.40	-	-	-	M71-31-423	BMP71	M71-R6000HF	250	1
▲	B-7351	F	38.10	25.40	-	-	-	PTL-31-7351	BMP61, BMP71	R6000HF	250	1
▲	B-499	FNA	38.10	25.40	-	-	-	PTL-31-499	BMP61, BMP71	R4310	250	1
▲	B-498	F	38.10	25.40	-	-	-	PTL-31-498	BMP61, BMP71	R6210	250	1
▲	B-423	F A	38.10	25.40	-	-	-	PTL-31-423	BMP61, BMP71	R6010	250	1
▲	B-499	FNA	38.10	31.75	-	-	-	M-132-499	BMP51, BMP53	-	160	1
▷	B-461	FNAHSL	38.10	88.90	-	38.10	31.75	PTL-77-461	BMP61, BMP71	R4310	100	1
▲	B-490	FN H L	38.10	98.43	-	-	-	PTL-114-490	BMP61, BMP71	R4310	100	1

\*\*AW = All White / no transparent area.

>>

F Freezer environment N Liquid nitrogen environment A Autoclave environment H Hot water bath (100°C) S Self-laminating label L Low-profile (extremely thin) label R Removable

# Bottles / Flasks & Dishes

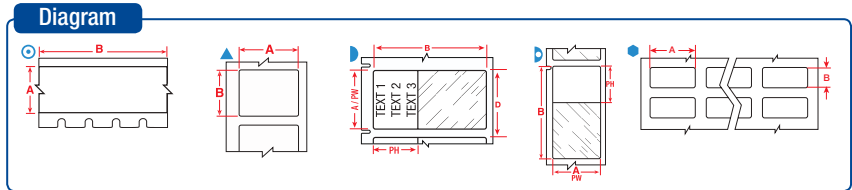

Labels are shown in order of label width.

The background colours in the Order Reference column represent the material colour.

See page 42 for Brady's range of label printers.

Diagram	Material	Special Properties	Label Width A (mm)	Label Height B (mm)	Label Length B (m)	Printable Area Width PW (mm)	Printable Area Height PH (mm)	Order Reference	Printer Compatibility	Printer Ribbon Series	Labels per Roll	Labels per Row
▲	B-488	F A	48.26	6.35	-	-	-	B33-635-488	BBP33	B30-R4300	2000	1
▲	B-499	F N A	48.26	25.40	-	48.26	25.40	PTL-78-499	BMP61, BMP71	R4310	250	1
▲	B-427	F N	48.26	25.40	-	48.26	25.40	PTL-78-427-AW***	BMP61, BMP71	R4310	250	1
▲	B-499	F N A	48.26	25.40	-	-	-	M71-78-499	BMP71	M71-R4300	250	1
▲	B-488	F A	48.26	25.40	-	-	-	PTL-78-488	BMP61, BMP71	R4310	250	1
▲	B-7351	F	48.26	76.2	-	-	-	PTL-37-351	BMP61, BMP71	R6000HF	100	1
⊙	B-499	F N A	48.26	-	9.10	-	-	M71C-1900-499	BMP71	M71-R4300	1	1
⊙	B-430	F A H	48.26	-	15.24	-	-	M71C-1900-430	BMP71	M71-R6000HF	1	1
▲	B-499	F N A	50.80	6.35	-	-	-	B33-151-499	BBP33	B30-R6000HF	1500	1
▲	B-499	F N A	50.80	6.35	-	-	-	THT-151-499-3	BBP12, BP-PR+, IP, i7100, i5100	R4900	3000	1
▲	B-499	F N A	50.80	6.35	-	-	-	THT-151-499-1.5-SC	BBP12, BP-PR+, IP	R7950	1500	1
▲	B-488	F A	50.80	6.35	-	-	-	THT-15-488-2.5	BBP12, BP-PR+, IP, i7100, i5100	R4300, R7950	2500	1
▲	B-499	F N A	50.80	25.40	-	-	-	B33-137-499	BBP33	B30-R6000HF	1100	1
▲	B-432	F A	50.80	25.40	-	-	-	B33-17-432	BBP33	B30-R6000HF	5000	1
▲	B-430	F A H	50.80	25.40	-	-	-	B33-17-430	BBP33	B30-R6000HF	1500	1
▲	B-425	F	50.80	25.40	-	-	-	B33-17-425	BBP33	B30-R4300	1500	1
▲	B-423	F A H	50.80	25.40	-	-	-	B33-17-423	BBP33	B30-R6000HF	1500	1
▲	B-8423	F A	50.80	25.40	-	-	-	BPT-17-8423-1	BBP12, BP-PR+, IP	R6000HF	1000	1
▲	B-7351	F	50.80	25.40	-	-	-	PTL-20-7351	BMP61, BMP71	R6000HF	100	1
▲	B-423	F A	50.80	25.40	-	-	-	PTL-20-423	BMP61, BMP71	R6010	100	1
▲	B-533	F A R	50.80	25.40	-	-	-	THT-17-533-3	BBP12, BP-PR+, IP, i7100, i5100	R6000HF	3000	1
▲	B-498	F R	50.80	25.40	-	-	-	THT-17-498-3	BBP12, BP-PR+, IP, i7100, i5100	R4300, R7950	3000	1
▲	B-498	F R	50.80	25.40	-	-	-	THT-17-498-1.5-SC	BBP12, BP-PR+, IP	R7950	1500	1
▲	B-430	F A H	50.80	25.40	-	-	-	THT-17-430-3	BBP12, BP-PR+, IP, i7100, i5100	R6000HF	3000	1
▲	B-425	F	50.80	25.40	-	-	-	THT-17-425-3	BBP12, BP-PR+, IP, i7100, i5100	R6400	3000	1
▲	B-423	F A H	50.80	25.40	-	-	-	THT-17-423-3	BBP12, BP-PR+, IP, i7100, i5100	R6000HF	3000	1
▲	B-490	F N H L	55.88	38.10	-	-	-	PTL-113-490	BMP61, BMP71	R4310	100	1
▲	B-8423	F A	69.85	31.75	-	-	-	BPT-7-8423-1	BBP12, BP-PR+, IP	R6000HF	1000	1
▲	B-432	F A	76.20	25.40	-	-	-	B33-18-432	BBP33	B30-R6000HF	1500	1
▲	B-430	F A H	76.20	25.40	-	-	-	B33-18-430	BBP33	B30-R6000HF	1500	1
▲	B-423	F A H	76.20	25.40	-	-	-	B33-18-423	BBP33	B30-R6000HF	1500	1
▲	B-423	F A H	76.20	25.40	-	-	-	THT-18-423-3	BBP12, BP-PR+, IP, i7100, i5100	R6000HF	3000	1
▲	B-432	F A	76.20	50.80	-	-	-	B33-19-432	BBP33	B30-R6000HF	500	1
▲	B-432	F A	76.20	50.80	-	-	-	THT-19-432-1	BBP12, BP-PR+, IP, i7100, i5100	R6000HF	1000	1
▲	B-490	F N H L	95.25	38.10	-	-	-	THT-158-490-3	BBP12, BP-PR+, IP, i7100, i5100	R4300, R7950	3000	1
▲	B-490	F N H L	95.25	38.10	-	-	-	THT-158-490-1.5-SC	BBP12, BP-PR+, IP	R7950	1500	1

F Freezer environment N Liquid nitrogen environment A Autoclave environment H Hot water bath (100°C) S Self-laminating label L Low-profile (extremely thin) label R Removable

- F** Freezer environment
- N** Liquid nitrogen environment
- A** Autoclave environment
- H** Hot water bath (100°C)
- S** Self-laminating label
- L** Low-profile (extremely thin) label
- R** Removable

## BOTTLE TAMPER SEAL LABELS

Brady's bottle seal identification provides tracking information with the added feature of security. These labelling materials are designed to fracture easily in order to show signs of sample tampering and to prevent one-piece label removal.

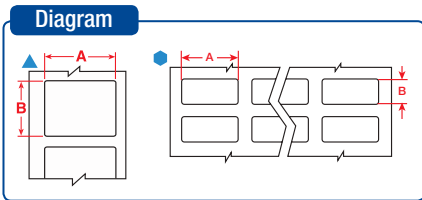

Labels are shown in order of label width.

The background colours in the Order Reference column represent the material colour.

See page 42 for Brady's range of label printers.

Diagram	Material	Special Properties	Label Width A (mm)	Label Height B (mm)	Order Reference	Printer Compatibility	Printer Ribbon Series	Labels per Roll	Labels per Row
▲	B-351	<b>F</b>	25.40	12.70	M-17-351	BMP51, BMP53	—	360	1
▲	B-351	<b>F</b>	25.40	12.70	M71-17-351	BMP71	M71-R6000HF	500	1
●	B-7351	<b>F</b>	25.40	12.70	THT-5-7351-10	BBP12, BP-PR+, IP, i7100, i5100	R6000HF	10000	3
▲	B-351	<b>F</b>	25.40	50.80	M-20-351	BMP51, BMP53	—	160	1
▲	B-351	<b>F</b>	25.40	50.80	M71-20-351	BMP71	M71-R6000HF	100	1
▲	B-351	<b>F</b>	38.10	25.40	M71-31-351	BMP71	M71-R6000HF	250	1
▲	B-7351	<b>F</b>	50.80	25.40	THT-17-7351-3	BBP12, BP-PR+, IP, i7100, i5100	R6000HF	3000	1
▲	B-351	<b>F</b>	76.20	48.26	M71-37-351	BMP71	M71-R6000HF	100	1

## General Lab ID

### B-403 WATER DISSOLVABLE LABEL

The B-403 water dissolvable paper label is self-adhesive and extremely easy to apply. Exposing the label to warm water will completely dissolve it within 30 seconds, without damage to the surface it was applied to, and without leaving any residue. The water dissolvable label adheres well to most surfaces, including glass, stainless steel, aluminium, plastic and others. This makes the label a great solution to enable short term identification for containers, crates and glassware with a minimum of waste.



Diagram	Material	Label Width A (mm)	Label Length B (mm)	Order Reference	Printer Compatibility	Printer Ribbon Series	Labels per Roll	Labels per Row
●	B-403	22.86	-	THT-141-403-3	BBP12, BP-PR+, IP, i7100, i5100	R4300	3000	2
∞	B-403	28.58	30.48	B30C-1125-403-WT	BBP33	B30-R4300	1	1
∞	B-403	28.58	91.44	THT-1125-403-WT	BBP12, BP-PR+, IP, i7100, i5100	R4300	1	1
▲	B-403	38.10	-	THT-136-403-3	BBP12, BP-PR+, IP, i7100, i5100	R4300	3000	1
▲	B-403	50.80	-	THT-17-403-3	BBP12, BP-PR+, IP, i7100, i5100	R4300	3000	1
∞	B-403	57.15	30.48	B30C-2250-403-WT	BBP33	B30-R4300	1	1
∞	B-403	57.15	91.44	THT-2250-403-WT	BBP12, BP-PR+, IP, i7100, i5100	R4300	1	1
▲	B-403	76.20	-	THT-19-403-1	BBP12, BP-PR+, IP, i7100, i5100	R4300	1000	1
▲	B-403	76.20	-	THT-18-403-3	BBP12, BP-PR+, IP, i7100, i5100	R4300	3000	1
∞	B-403	76.20	30.48	B30C-3000-403-WT	BBP33	B30-R4300	1	1
∞	B-403	76.20	91.44	THT-3000-403-WT	BBP12, BP-PR+, IP, i7100, i5100	R4300	1	1
▲	B-403	101.60	-	THT-55-403-1	BBP12, BP-PR+, IP, i7100, i5100	R4300	1000	1
∞	B-403	101.60	30.48	B30C-4000-403-WT	BBP33	B30-R4300	1	1
∞	B-403	101.60	91.44	THT-4000-403-WT	BBP12, BP-PR+, IP, i7100, i5100	R4300	1	1

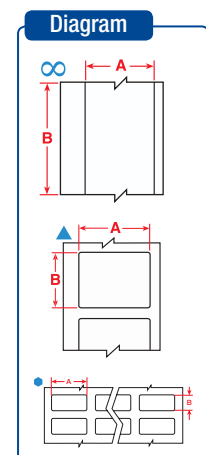

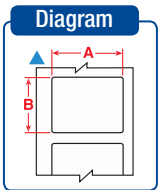

## B-7425-AC STERILISATION INDICATING LABEL

Sterilisation indicating labels provide users with proof of sterilisation. They are ideal for a broad range of laboratory processes including sample tracking, inventory management, general tracking, and glassware or tray identification.

Diagram	Material	Label Width A (mm)	Label Height B (mm)	Order Reference	Printer Compatibility	Printer Ribbon Series	Labels per Roll	Labels per Row
▲	B-7425	38.10	25.40	B33-235-7425-AC	BBP33	B30-R4300	1250	1
▲	B-7425	38.10	25.40	THT-235-7425-2-AC	BBP12, BP-PR+, IP, i7100, i5100	R4300	2000	1
▲	B-7425	50.80	25.40	B33-137-7425-AC	BBP33	B30-R4300	1500	1
▲	B-7425	50.80	25.40	THT-137-7425-2-AC	BBP12, BP-PR+, IP, i7100, i5100	R4300	2000	1



## GENERAL LAB ID

Just like a durable sample label lets you know which sample you are holding, a cabinet or drawer label can inform you of the cabinet's content. With proper identification, time spent looking for the right sample or tool can be invested in what really matters. Brady offers a range of materials suitable for identifying drawers, cabinets, shelves, storage units and laboratory equipment.

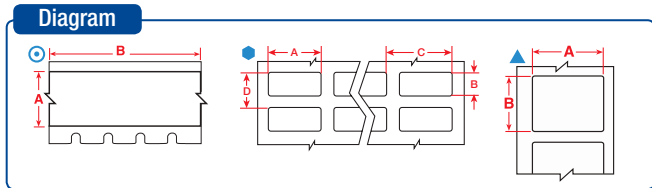

Labels are shown in order of label width.

The background colours in the Order Reference column represent the material colour.

See page 42 for Brady's range of label printers.

Diagram	Material	Special Properties	Label Width A (mm)	Label Height B (mm)	Label Length B (m)	Order Reference	Printer Compatibility	Printer Ribbon Series	Labels per Roll	Labels per Row
○	B-595	F	6.35	-	6.40	M21-250-595-WT	BMP21-LAB	-	1	1
○	B-595	F	6.35	-	6.40	M21-250-595-YL	BMP21-LAB	-	1	1
○	B-430	F AH	6.35	-	6.40	M21-250-430	BMP21-LAB	-	1	1
○	B-430	F AH	6.35	-	6.40	M21-250-430-WT-CL	BMP21-LAB	-	1	1
○	B-423	F AH	6.35	-	6.40	M21-250-423	BMP21-LAB	-	1	1
▲	B-499	F NA	9.53	20.96	-	M-130-499	BMP51, BMP53	-	220	1
○	B-499	F NA	9.53	-	4.88	M21-375-499	BMP21-LAB	-	1	1
○	B-499	F NA	9.53	-	4.88	MC-375-499	BMP51, BMP53	-	1	1
○	B-595	F	9.53	-	6.40	M21-375-595-BK	BMP21-LAB	-	1	1
○	B-595	F	9.53	-	6.40	M21-375-595-BL	BMP21-LAB	-	1	1
○	B-595	F	9.53	-	6.40	M21-375-595-GN	BMP21-LAB	-	1	1
○	B-595	F	9.53	-	6.40	M21-375-595-OR	BMP21-LAB	-	1	1
○	B-595	F	9.53	-	6.40	M21-375-595-RD	BMP21-LAB	-	1	1
○	B-595	F	9.53	-	6.40	M21-375-595-WT	BMP21-LAB	-	1	1
○	B-595	F	9.53	-	6.40	M21-375-595-YL	BMP21-LAB	-	1	1
○	B-488	F A	9.53	-	6.40	M21-375-488	BMP21-LAB	-	1	1
○	B-430	F AH	9.53	-	6.40	M21-375-430	BMP21-LAB	-	1	1
○	B-430	F AH	9.53	-	6.40	M21-375-430-WT-CL	BMP21-LAB	-	1	1
○	B-423	F AH	9.53	-	6.40	M21-375-423	BMP21-LAB	-	1	1
○	B-595	F	9.53	-	7.62	MC-375-595-WT-BK	BMP51, BMP53	-	1	1
○	B-595	F	9.53	-	7.62	MC-375-595-YL-BK	BMP51, BMP53	-	1	1
○	B-430	F AH	9.53	-	15.24	M71C-375-430	BMP71	M71-R6000HF	1	1
▲	B-499	F NA	12.70	25.40	-	M-131-499	BMP51, BMP53	-	180	1
▲	B-498	F R	12.70	25.40	-	M-131-498	BMP51, BMP53	-	180	1
▲	B-424	F	12.70	50.80	-	B33-53-424	BBP33	B30-R4300	2500	1
○	B-499	F NA	12.70	-	4.88	M21-500-499	BMP21-LAB	-	1	1
○	B-499	F NA	12.70	-	4.88	MC-500-499	BMP51, BMP53	-	1	1
○	B-595	F	12.70	-	6.10	MC-500-595-CL-BK	BMP51, BMP53	-	1	1
○	B-595	F	12.70	-	6.10	MC-500-595-CL-WT	BMP51, BMP53	-	1	1

>>

F Freezer environment N Liquid nitrogen environment A Autoclave environment H Hot water bath (100°C) S Self-laminating label L Low-profile (extremely thin) label R Removable



## Diagram

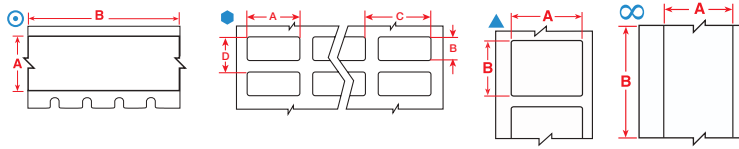

Diagram	Material	Special Properties	Label Width A (mm)	Label Height B (mm)	Label Length B (m)	Order Reference	Printer Compatibility	Printer Ribbon Series	Labels per Roll	Labels per Row
⊙	B-595	F	12.70	-	6.40	M21-500-595-BK	BMP21-LAB	-	1	1
⊙	B-595	F	12.70	-	6.40	M21-500-595-BL	BMP21-LAB	-	1	1
⊙	B-595	F	12.70	-	6.40	M21-500-595-GN	BMP21-LAB	-	1	1
⊙	B-595	F	12.70	-	6.40	M21-500-595-OR	BMP21-LAB	-	1	1
⊙	B-595	F	12.70	-	6.40	M21-500-595-RD	BMP21-LAB	-	1	1
⊙	B-595	F	12.70	-	6.40	M21-500-595-WT	BMP21-LAB	-	1	1
⊙	B-595	F	12.70	-	6.40	M21-500-595-YL	BMP21-LAB	-	1	1
⊙	B-488	F A	12.70	-	6.40	M21-500-488	BMP21-LAB	-	1	1
⊙	B-430	F A H	12.70	-	6.40	M21-500-430	BMP21-LAB	-	1	1
⊙	B-430	F A H	12.70	-	6.40	M21-500-430-WT-CL	BMP21-LAB	-	1	1
⊙	B-423	F A H	12.70	-	6.40	M21-500-423	BMP21-LAB	-	1	1
⊙	B-595	F	12.70	-	7.62	MC-500-595-BK-WT	BMP51, BMP53	-	1	1
⊙	B-595	F	12.70	-	7.62	MC-500-595-BL-WT	BMP51, BMP53	-	1	1
⊙	B-595	F	12.70	-	7.62	MC-500-595-GN-WT	BMP51, BMP53	-	1	1
⊙	B-595	F	12.70	-	7.62	MC-500-595-OR-BK	BMP51, BMP53	-	1	1
⊙	B-595	F	12.70	-	7.62	MC-500-595-RD-WT	BMP51, BMP53	-	1	1
⊙	B-595	F	12.70	-	7.62	MC-500-595-WT-BK	BMP51, BMP53	-	1	1
⊙	B-595	F	12.70	-	7.62	MC-500-595-WT-RD	BMP51, BMP53	-	1	1
⊙	B-595	F	12.70	-	7.62	MC-500-595-YL-BK	BMP51, BMP53	-	1	1
⊙	B-499	F N A	12.70	-	9.10	M71C-500-499	BMP71	M71-R4300	1	1
⊙	B-595	F	12.70	-	15.24	M71C-500-595-BK	BMP71	M71-R4400-WT	1	1
⊙	B-595	F	12.70	-	15.24	M71C-500-595-BL	BMP71	M71-R4400-WT	1	1
⊙	B-595	F	12.70	-	15.24	M71C-500-595-CL	BMP71	M71-R6000HF	1	1
⊙	B-595	F	12.70	-	15.24	M71C-500-595-GN	BMP71	M71-R4400-WT	1	1
⊙	B-595	F	12.70	-	15.24	M71C-500-595-OR	BMP71	M71-R6000HF	1	1
⊙	B-595	F	12.70	-	15.24	M71C-500-595-RD	BMP71	M71-R4400-WT	1	1
⊙	B-595	F	12.70	-	15.24	M71C-500-595-WT	BMP71	M71-R6000HF	1	1
⊙	B-595	F	12.70	-	15.24	M71C-500-595-YL	BMP71	M71-R6000HF	1	1
⊙	B-430	F A H	12.70	-	15.24	M71C-500-430	BMP71	M71-R6000HF	1	1
∞	B-595	F	12.70	-	30.40	B30C-500-595-BK	S3100, BBP30/31/33/35/37	B30-R10000-WT	1	1
∞	B-595	F	12.70	-	30.40	B30C-500-595-BL	S3100, BBP30/31/33/35/37	B30-R10000-WT	1	1
∞	B-595	F	12.70	-	30.40	B30C-500-595-CL	S3100, BBP30/31/33/35/37	B30-R10000	1	1
∞	B-595	F	12.70	-	30.40	B30C-500-595-GN	S3100, BBP30/31/33/35/37	B30-R10000-WT	1	1
∞	B-595	F	12.70	-	30.40	B30C-500-595-OR	S3100, BBP30/31/33/35/37	B30-R10000	1	1
∞	B-595	F	12.70	-	30.40	B30C-500-595-RD	S3100, BBP30/31/33/35/37	B30-R10000-WT	1	1
∞	B-595	F	12.70	-	30.40	B30C-500-595-WT	S3100, BBP30/31/33/35/37	B30-R10000	1	1
∞	B-595	F	12.70	-	30.40	B30C-500-595-YL	S3100, BBP30/31/33/35/37	B30-R10000	1	1
⊙	B-499	F N A	19.05	-	4.88	M21-750-499	BMP21-LAB	-	1	1
⊙	B-499	F N A	19.05	-	4.88	MC-750-499	BMP51, BMP53	-	1	1
⊙	B-595	F	19.05	-	6.10	MC-750-595-CL-BK	BMP51, BMP53	-	1	1
⊙	B-595	F	19.05	-	6.10	MC-750-595-CL-WT	BMP51, BMP53	-	1	1
⊙	B-595	F	19.05	-	6.40	M21-750-595-BK	BMP21-LAB	-	1	1
⊙	B-595	F	19.05	-	6.40	M21-750-595-BL	BMP21-LAB	-	1	1
⊙	B-595	F	19.05	-	6.40	M21-750-595-GN	BMP21-LAB	-	1	1
⊙	B-595	F	19.05	-	6.40	M21-750-595-OR	BMP21-LAB	-	1	1
⊙	B-595	F	19.05	-	6.40	M21-750-595-RD	BMP21-LAB	-	1	1
⊙	B-595	F	19.05	-	6.40	M21-750-595-WT	BMP21-LAB	-	1	1
⊙	B-595	F	19.05	-	6.40	M21-750-595-YL	BMP21-LAB	-	1	1
⊙	B-488	F A	19.05	-	6.40	M21-750-488	BMP21-LAB	-	1	1
⊙	B-430	F A H	19.05	-	6.40	M21-750-430	BMP21-LAB	-	1	1
⊙	B-430	F A H	19.05	-	6.40	M21-750-430-WT-CL	BMP21-LAB	-	1	1
⊙	B-423	F A H	19.05	-	6.40	M21-750-423	BMP21-LAB	-	1	1
⊙	B-595	F	19.05	-	7.62	MC-750-595-BK-WT	BMP51, BMP53	-	1	1
⊙	B-595	F	19.05	-	7.62	MC-750-595-BL-WT	BMP51, BMP53	-	1	1
⊙	B-595	F	19.05	-	7.62	MC-750-595-GN-WT	BMP51, BMP53	-	1	1
⊙	B-595	F	19.05	-	7.62	MC-750-595-OR-BK	BMP51, BMP53	-	1	1
⊙	B-595	F	19.05	-	7.62	MC-750-595-RD-WT	BMP51, BMP53	-	1	1
⊙	B-595	F	19.05	-	7.62	MC-750-595-WT-BK	BMP51, BMP53	-	1	1
⊙	B-595	F	19.05	-	7.62	MC-750-595-WT-RD	BMP51, BMP53	-	1	1
⊙	B-595	F	19.05	-	7.62	MC-750-595-YL-BK	BMP51, BMP53	-	1	1

>>

F Freezer environment N Liquid nitrogen environment A Autoclave environment H Hot water bath (100°C) S Self-laminating label L Low-profile (extremely thin) label R Removable

# General Lab ID

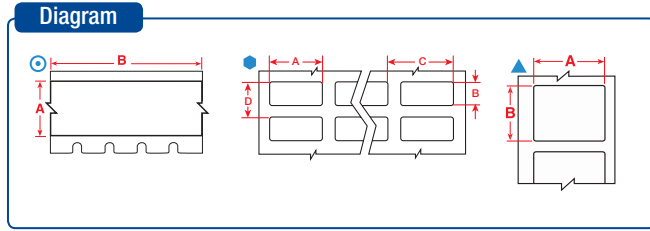

Diagram	Material	Special Properties	Label Width A (mm)	Label Height B (mm)	Label Length B (m)	Order Reference	Printer Compatibility	Printer Ribbon Series	Labels per Roll	Labels per Row
●	B-423	F AH	25.40	12.70	-	B33-5-423	BBP33	B30-R6000HF	5000	3
▲	B-432	F A	25.40	12.70	-	M-17-432-CL-BK	BMP51, BMP53	-	280	1
▲	B-498	F R	25.40	12.70	-	M71-17-498	BMP71	M71-R6200	500	1
▲	B-430	F AH	25.40	12.70	-	M71-17-430	BMP71	M71-R6000HF	500	1
▲	B-498	F R	25.40	12.70	-	THT-59-498-2.5-SC	BBP12, BP-PR+	R7950	2500	1
●	B-488	F A	25.40	12.70	-	THT-5-488-10	BBP12, BP-PR+, IP, i7100, i5100	R4300, R7950	10000	3
▲	B-499	F NA	25.40	25.40	-	M71-19-499	BMP71	M71-R4300	250	1
▲	B-492	F N H L	25.40	25.40	-	M71-19-492	BMP71	M71-R6400	250	1
▲	B-498	F R	25.40	31.75	-	M-103-498	BMP51, BMP53	-	160	1
▲	B-498	F R	25.40	48.26	-	M-128-498	BMP51, BMP53	-	100	1
▲	B-432	F A	25.40	48.26	-	M-78-432-CL-BK	BMP51, BMP53	-	100	1
▲	B-424	F	25.40	50.80	-	BM71-20-424	BMP61, BMP71	R4300	1000	1
▲	B-424	F	25.40	50.80	-	M71-20-424	BMP71	M71-R4300	100	1
○	B-499	F NA	25.40	-	4.88	MC-1000-499	BMP51, BMP53	-	1	1
○	B-595	F	25.40	-	6.10	MC1-1000-595-CL-BK	BMP51, BMP53	-	1	1
○	B-595	F	25.40	-	6.10	MC1-1000-595-CL-WT	BMP51, BMP53	-	1	1
○	B-595	F	25.40	-	7.62	MC1-1000-595-BK-WT	BMP51, BMP53	-	1	1
○	B-595	F	25.40	-	7.62	MC1-1000-595-BL-WT	BMP51, BMP53	-	1	1
○	B-595	F	25.40	-	7.62	MC1-1000-595-GN-WT	BMP51, BMP53	-	1	1
○	B-595	F	25.40	-	7.62	MC1-1000-595-OR-BK	BMP51, BMP53	-	1	1
○	B-595	F	25.40	-	7.62	MC1-1000-595-RD-WT	BMP51, BMP53	-	1	1
○	B-595	F	25.40	-	7.62	MC1-1000-595-WT-BK	BMP51, BMP53	-	1	1
○	B-595	F	25.40	-	7.62	MC1-1000-595-WT-RD	BMP51, BMP53	-	1	1
○	B-595	F	25.40	-	7.62	MC1-1000-595-YL-BK	BMP51, BMP53	-	1	1
○	B-499	F NA	25.40	-	9.10	M71C-1000-499	BMP71	M71-R4300	1	1
○	B-595	F	25.40	-	15.24	M71C-1000-595-BK	BMP71	M71-R4400-WT	1	1
○	B-595	F	25.40	-	15.24	M71C-1000-595-BL	BMP71	M71-R4400-WT	1	1
○	B-595	F	25.40	-	15.24	M71C-1000-595-CL	BMP71	M71-R6000HF	1	1
○	B-595	F	25.40	-	15.24	M71C-1000-595-GN	BMP71	M71-R4400-WT	1	1
○	B-595	F	25.40	-	15.24	M71C-1000-595-OR	BMP71	M71-R6000HF	1	1
○	B-595	F	25.40	-	15.24	M71C-1000-595-RD	BMP71	M71-R4400-WT	1	1
○	B-595	F	25.40	-	15.24	M71C-1000-595-WT	BMP71	M71-R6000HF	1	1
○	B-595	F	25.40	-	15.24	M71C-1000-595-YL	BMP71	M71-R6000HF	1	1
○	B-430	F AH	25.40	-	15.24	M71C-1000-430	BMP71	M71-R6000HF	1	1
▲	B-498	F R	26.67	6.35	-	THT-199-498-3	BBP12, BP-PR+, IP, i7100, i5100	R4300, R7950	3000	1
▲	B-498	F R	26.67	6.35	-	THT-199-498-3-SC	BBP12, BP-PR+	R7950	3000	1
▲	B-423	F AH	31.75	69.85	-	M71-26-423	BMP71	M71-R6000HF	100	1
●	B-449	F A R	38.10	19.05	-	THT-6-449-3	BBP12, BP-PR+, IP, i7100, i5100	R4300, R7950	3000	2
●	B-449	F A R	38.10	19.05	-	THT-6-449-1.5-SC	BBP12, BP-PR+	R7950	1500	2
●	B-423	F AH	38.10	19.05	-	THT-6-423-10	BBP12, BP-PR+, IP, i7100, i5100	R6000HF	10000	2
▲	B-499	F NA	38.10	31.75	-	M-132-499	BMP51, BMP53	-	160	1
○	B-499	F NA	48.26	-	9.10	M71C-1900-499	BMP71	M71-R4300	1	1
○	B-430	F AH	48.26	-	15.24	M71C-1900-430	BMP71	M71-R6000HF	1	1
▲	B-424	F	50.80	12.70	-	THT-53-424-3	BBP12, BP-PR+, IP, i7100, i5100	R4300, R7950	3000	1
▲	B-423	F AH	50.80	12.70	-	THT-53-423-3	BBP12, BP-PR+, IP, i7100, i5100	R6000HF	3000	1
▲	B-424	F	50.80	25.40	-	B33-17-424	BBP33	B30-R4300	1500	1
▲	B-423	F AH	50.80	25.40	-	B33-17-423	BBP33	B30-R6000HF	1500	1
▲	B-8423	F A	50.80	25.40	-	BPT-17-8423-1	BBP12, BP-PR+	R6000HF	1000	1
▲	B-498	F R	50.80	25.40	-	THT-17-498-3	BBP12, BP-PR+, IP, i7100, i5100	R4300, R7950	3000	1
▲	B-498	F R	50.80	25.40	-	THT-17-498-1.5-SC	BBP12, BP-PR+	R7950	1500	1
▲	B-449	F A R	50.80	25.40	-	THT-17-449-3	BBP12, BP-PR+, IP, i7100, i5100	R4300, R7950	3000	1
▲	B-449	F A R	50.80	25.40	-	THT-17-449-1.5-SC	BBP12, BP-PR+	R7950	1500	1
▲	B-424	F	50.80	25.40	-	THT-17-424-3	BBP12, BP-PR+, IP, i7100, i5100	R4300, R7950	3000	1
▲	B-423	F AH	50.80	25.40	-	THT-17-423-3	BBP12, BP-PR+, IP, i7100, i5100	R6000HF	3000	1
▲	B-8423	F A	69.85	31.75	-	BPT-7-8423-1	BBP12, BP-PR+	R6000HF	1000	1
▲	B-423	F AH	76.20	25.40	-	B33-18-423	BBP33	B30-R6000HF	1500	1
▲	B-430	F AH	76.20	25.40	-	THT-18-430-3	BBP12, BP-PR+, IP, i7100, i5100	R6000HF	3000	1
▲	B-423	F AH	76.20	25.40	-	THT-18-423-3	BBP12, BP-PR+, IP, i7100, i5100	R6000HF	3000	1
▲	B-430	F AH	76.20	50.80	-	THT-19-430-1	BBP12, BP-PR+, IP, i7100, i5100	R6000HF	1000	1

F Freezer environment N Liquid nitrogen environment A Autoclave environment H Hot water bath (100°C) S Self-laminating label L Low-profile (extremely thin) label R Removable



## Label Printers, Label Attachment System and Barcode Scanners

Brady printers enable professionals to print highly specialised identification labels on-site and on demand. Partnered with labelling software for laboratories, Brady printers support considerable time savings and flexibility in sample identification.

For enhanced security Brady offers a label attachment system that rivets an adhesive label to tissue cassettes before the tissue embedding process.

To complete your sample ID automation, Brady has a range of barcode scanners which combine the industry's best imaging technology with a graphic display and rugged keyboard for fast, user-friendly data and inventory management.

Choose Your Printer .....	42
BMP21-LAB Label Printer .....	44
BMP51 Label Printer .....	45
BMP61 Label Printer .....	46
BMP71 Label Printer .....	48
BBP12 Label Printer .....	49
BBP33 Label Printer .....	50
BradyPrinter i5100 .....	51
BradyPrinter i7100 .....	52
BSP31 Label Attachment System .....	54
Label Creation Software .....	55
Scanners for Laboratories .....	56

# Choose Your Printer - portable printers



**BMP21-LAB Label Printer**

**BMP51 Label Printer**

**BMP61 Label Printer**

**BMP71 Label Printer**

The BMP21-LAB Portable Label Printer is an all-in-one labeller for research, academic and clinical labs. The BMP21-LAB printer can quickly and easily create legible labels for flat, curved or highly textured surfaces that stay stuck for years even when exposed to extreme temperatures and chemicals.

A powerful portable printer for on the job labelling in laboratories. With its extensive connectivity and networking options this easy to use system prints a large variety of high quality continuous and die-cut materials up to 38 mm wide.

Performance that matches your own. Your trusted identification companion of choice, all day, every day, for years to come. Also available in a wifi enabled version. Colour touch screen with on-screen indicators. On-board USB list management. Prints continuous, die cut labels and bulk rolls up to 50.8mm extremely fast. Also customs.

The most versatile portable printer for on the job labelling in laboratories. With its optimal efficiency it helps to reduce material waste and saves label making time. It prints on the largest variety of high quality continuous and die-cut materials up to 50 mm wide and offers an option to have custom materials created.

Features				
<b>Recommended Usage per Day</b>	75	500	750	1000 50.8x25.4mm labels per day
<b>Resolution (dpi)</b>	203	300	300	300
<b>Print Technology</b>	Thermal Transfer	Thermal Transfer	–	Thermal Transfer
<b>Print Speed (mm/sec)</b>	10.00	25.40	33.8	38.10
<b>Max Label Width</b>	19.00 mm	38.10 mm	50.80 mm	50.80 mm
<b>Text Sizes (pt)</b>	6 - 40 pt	4 - 102 pt	4 - 174 pt	4 - 174 pt
<b>Max Print Width</b>	16.00 mm	36.00 mm	48.76 mm	45.97 mm
<b>Bar Code Capability</b>	Code 39 and 128, Datamatrix and QR Code	Code 39 and 128, other via software	Code 39 and 128, other via software	Code 39 and 128, other via software
<b>Built-in Symbols</b>	215 symbols included	450 symbols included	450 symbols included	500+ symbols included
<b>Flash Memory</b>	Stores 12 labels	48 MB - up to 25,000 labels	512MB - up to 250,000 labels	200 MB -up to 100,000 labels
<b>Materials Supported</b>	60+ standard parts: continuous tapes	200+ standard parts: continuous tapes and die cut labels	600+ standard parts: continuous tapes, die cut and bulk label rolls, custom made labels and tapes.	400+ standard parts: continuous tapes, die cut and bulk label rolls, custom made labels and tapes
<b>Stand-alone Printing (Detached from PC)</b>	Stand-alone	Stand-alone & Peripheral	Stand-alone & Peripheral	Stand-alone & Peripheral
<b>Colour Capability</b>	Monocolour	Monocolour	Monocolour	Monocolour
<b>Connectivity</b>	–	USB, Bluetooth. Optional: Ethernet, WiFi	USB 2.0, USB Flash Drive, Optional WiFi (factory installed)	USB
<b>Keyboard</b>	ABC	QWERTY	QWERTY, QWERTZ, AZERTY, CYRILLIC	QWERTY, QWERTZ, AZERTY, CYRILLIC
<b>Power Supply</b>	6 AA Batteries, rechargeable battery, AC adaptor	AC Adaptor, 8 AA batteries, rechargeable battery	AC adaptor, rechargeable battery	AC adaptor, rechargeable battery
<b>Weight (kg)</b>	0.75 kg	1.20 kg	1.5 kg	2.49 kg

# Choose Your Printer - benchtop printers



**BBP12 Label Printer**

**BBP33 Label Printer**

**BradyPrinter i5100  
Industrial Label Printer**

**BradyPrinter i7100  
Industrial Label Printer**

The BBP12 Label Printer is an entry level benchtop label printer for cable, component, product and laboratory sample identification that offers great value for money. The compact BBP12 offers a high print speed of 100 mm/second and can handle a wide range of highly durable and specialised Brady identification labels.

Completely hassle free, easy to use PC-based printer. Smart chip supplies automatically set up the label in your Brady software. Drop-in ribbon and label cartridges ensure fast and effortless material changes.

The BradyPrinter i5100 Industrial Label Printer offers a perfect mix of performance & smarts. This benchtop printer can print on 70 label materials, more than 1200 stock label parts and tailored custom label materials and parts. Applications include a wide range of specialised and commonly used product labels, electronics and PCB labels, logistics and asset tracking labels, cable & component identification labels and laboratory sample labels.

The BradyPrinter i7100 industrial thermal transfer benchtop printer is ideal for customers requiring reliable high volume printing on lots of different materials within the Aerospace, Defence and Mass Transit, Electronics, Automotive, Logistics, Electrical, Voice-Datacom and LAB markets. It guarantees accurate printing on sleeves, tags, labels, tapes, cable markers and much more.

## Features

<b>Recommended Usage per Day</b>	500	1000	5000	7000
<b>Resolution (dpi)</b>	300	300	300 / 600	300 / 600
<b>Print Technology</b>	Thermal Transfer	Thermal Transfer	Thermal Transfer	Thermal Transfer
<b>Print Speed (mm/sec)</b>	101.6	101.6	up to 300mm/sec	up to 300
<b>Max Label Width</b>	112 mm	106 mm	110 mm	110 mm
<b>Text Sizes (pt)</b>	–	–	–	–
<b>Max Print Width</b>	105.6 mm	101.6 mm	105.7 mm	105.7 mm
<b>Bar Code Capability</b>	2D and 1D (Linear)	Via software	Linear Barcodes, 2D barcodes.	Linear barcodes, 2D and stacked codes.
<b>Built-in Symbols</b>	–	–	–	–
<b>Flash Memory</b>	64 MB	4 GB	–	256 MB
<b>Materials Supported</b>	Nylon Cloth, Paper, Polyester, Polyethylene, Polyimide, Polyolefin (Sleeves), Polypropylene, Thermoplastic polyether-polyurethane, Vinyl, Vinyl Cloth, Outdoor Vinyl, Self-laminating Vinyl	Die Cut, Continuous & Custom	The BradyPrinter i5100 can print on 70 label materials, more than 1200 stock label parts and tailored custom label materials and parts.	The BradyPrinter i7100 can print on 100+ label materials, 3,000+ stock label parts, 40+ specialty ribbons and made-to-spec custom materials.
<b>Stand-alone Printing (Detached from PC)</b>	Stand-alone & Peripheral	Peripheral	Stand-alone & Peripheral	Stand-alone & Peripheral
<b>Colour Capability</b>	Monocolour	Monocolour	Monocolour	Monocolour
<b>Connectivity</b>	Serial, USB, Ethernet	USB, Ethernet. Optional: WiFi, Bluetooth	USB, Serial, Ethernet. Optional: WiFi, Bluetooth	USB, Serial, Parallel, Ethernet
<b>Keyboard</b>	Optional	None	None	None
<b>Hardware Options</b>	Peel & Present, Universal Keyboard	–	Ribbon Take up Spindle; Label Roll Holder; Platen Rollers	Cutter with Tray, Cutter Perforator, Present Sensor, Peel Off, Rewinder, Platen Rollers
<b>Weight (kg)</b>	2.5 kg	5.3 kg	6.62 kg	10 kg





## BMP™ 21-LAB LABEL PRINTER

### Tough on the outside, Genius on the inside

Combining a tough exterior with smart printing capabilities, the BMP21-LAB hand-held label printer can take a hit and still perform. **Laboratory symbols** & vial/tube auto-sizing, plus drop-lock-and-go cartridges, plus a rechargeable Lithium-ion battery adds up to a powerful and affordable tool for quick and efficient label making in any type of laboratory. **High quality label materials** designed specifically for the laboratory environment create durable, professional looking labels for your laboratory samples and beyond.

### Designed for Laboratory

- Materials available for applications such as cryo vials and slides
- Greek symbols commonly used in laboratory, intuitive menu structure for symbols
- Vial label function automatically cuts the tape according to the size of the vial
- Automated serialisation
- Time & Date stamp

### Easy to use

- 3 line LCD display provides clear visibility
- ABC keypad, graphics library, hot keys and menu functions for fast label creation
- Long life rechargeable Lithium-ion battery\*
- Smart Cell Technology for automatic label setup
- Automatic label formatting for commonly used label types in laboratory
- Magnet accessory\* for more convenient use and storage on smaller laboratory benches and a lanyard for hands-free operation
- Ergonomic, centre balanced printer with grab and go ridges grip for easy handling

### Exceptional material variety and durability

- Laboratory specific materials designed to withstand harsh laboratory environments.
- High quality, long lasting labels that stick and stay stuck
- Prints durable true-sized 6 – 19 mm wide identification to maximise amount of data
- Adjust the length of the labels using the high performance continuous material
- Fulfill your requirements with a range of different industry specified materials that last

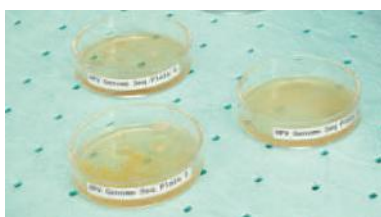

### View online

Visit [www.bradyeurope.com/BMP21-LAB](http://www.bradyeurope.com/BMP21-LAB) for more information on the BMP21-LAB Label Printer.

### BMP21-LAB LABEL PRINTER

Art. No.	Description
139538	BMP21-LAB Label Printer - Blister Pack

Blister package contains: Printer, Lanyard, Quick Start Guide, M21-750-7425 label cartridge

### BMP21-LAB STARTER KITS

Art. No.	Description
134474	BMP21-LAB Label Printer - Kit - EU
134475	BMP21-LAB Label Printer - Kit - UK
134476	BMP21-LAB Label Printer - Kit - US

Printer Kit contains: Printer, Li-ion Battery, Power Cord, Lanyard, Quick Start Guide, M21-750-7425 label cartridge

### ACCESSORIES

Art. No.	Description
110416	AC Adaptor - Europe 220V
110417	AC Adaptor - UK 240V
110891	Magnet Only Accessory
110892	Multifunctional Accessory
110937	AC Adaptor - US 110V
139540	Li-ion battery Pack for BMP21-PLUS; BMP21-LAB



 BMP21-LAB cartridges can be used in the first generation BMP21 and LABPAL Label Printer.

\*Accessories sold separately. Battery included in the Starter Kit only.

# BMP51 LABEL PRINTER

The BMP51 Label Printer is a compact, versatile portable printer with built-in Bluetooth® technology for wireless printing.

- Identify your samples quickly and more efficiently
- Portable/Handheld
- Labels withstand extreme laboratory temperatures and solvents
- Durable built-in cutter that retains the label after it's cut until you need it
- Built-in Bluetooth® or optional Wi-Fi card for wireless printing from a network
- A magnet accessory to keep your printer handy
- Serialisation feature for quicker aliquots



## BMP51 LABEL PRINTER

Art. No.	Order Reference	Description
710894	BMP51 PRINTER EU	BMP51 Label Printer - EU
198630	BMP51-EU-PWID	BMP51 Label Printer - EU with Brady Workstation PWID Suite
710898	BMP51 PRINTER KIT UK	BMP51 Label Printer - UK
198631	BMP51-UK-PWID	BMP51 Label Printer - UK with Brady Workstation PWID Suite

The Basic Suite is included with every printer, all you need to do is download it. [Workstation.BradyID.com/Free](http://Workstation.BradyID.com/Free)

**i** For more information about the Brady Workstation Software Suites, see page 55.



## BMP51 LABORATORY KITS

Art. No.	Order Reference	Description
198655	BMP51-EU-LAB	BMP51 Laboratory Kit EU
198658	BMP51-UK-LAB	BMP51 Laboratory Kit UK

This printer ships in a hard case with a Rechargeable Lithium Ion Battery, USB Cable, AC adaptor with power cord, Product CD, Brady Printer Drivers CD, Quick Start Guide, a Bluetooth network card, a Brady Workstation Product & Wire Identification Suite, M-122-461, M-131-499 and an MC1-1000-422 cartridge.



## BMP51 ACCESSORIES

Art. No.	Order Reference	Description
142261	UBP-LI-ION-AC-120v	Univeral Li-ion Battery Pack with AC Adaptor/Battery Pack US
710902	UBP-LI-ION-AC-EUR	Univeral Li-ion Battery Pack with AC Adaptor/Battery Pack EU
710903	UBP-LI-ION-AC-UK	Univeral Li-ion Battery Pack with AC Adaptor/Battery Pack UK
114883	M41/50/61/71-AC-BC-NA	AC Adaptor - USA 120V
710612	M41/50/61/71-BC-EU	AC Adaptor - Europe 220V
710613	M41/50/61/71-AC-BC-UK	AC Adaptor - UK 240V
142260	BMP-UBP 12V	Universal Li-Ion Battery Pack
143115	M50-BATT-TRAY	BMP50 Series Spare Battery Tray for 8 AA batteries
143109	M50-HC	BMP50 Series Hard Carry Case
121423	M50-SC	BMP50 Series Soft Carry Case
143108	M50-MAGNET	BMP50 Series Magnet Accessory
142265	NET-BT	Bluetooth Network Card
142268	NET-WIFI-LAN	WiFi/ LAN Network Card
142267	NET-LAN	LAN Network Card
143114	BMP41-BMP50-USB	BMP41-BMP50 Series USB Cable



**i** **View online**  
Visit [www.bradyeurope.com/BMP51](http://www.bradyeurope.com/BMP51) for more information on the BMP51 Label Printer.





## BMP61 LABEL PRINTER

### Rugged & Reliable

- Drop-tested and equipped with moulded rubber bumpers
- Large material loading bay for fast label material swaps
- Smart-cell cartridge technology enables auto-calibration
- Large colour touchscreen with on-screen indicators: easily check which label cartridge is installed and how many labels you have left. Quickly review your label on the display before printing to avoid mistakes
- 33.8 mm/second print speed: Don't wait on the label you need
- Rechargeable NiMH-Battery for increased autonomy
- 2 year warranty

### High-Performance Materials & excellent print quality

- 600 label materials + custom labels: don't use a half-baked solution. Choose from 600 label material (sleeves, self-lams and more) and ink ribbon combinations, or ask Brady to develop custom labels to answer your needs!
- Handles die-cut, continuous and custom labels up to 50.80 mm - also in bulk format
- Intuitive typing thanks to the AZERTY/QWERTY/QWERTZ/CYRILLIC keyboards
- 300 dpi print quality



### VIEW ONLINE

Visit [www.bradyeurope.com/BMP61](http://www.bradyeurope.com/BMP61) for more information on the BMP61 Label Printer.

## BMP61 LABEL PRINTER

Order Reference	Art. No.	Description
BMP61-QWERTZ-EU-W	146224	BMP61 Label Printer - QWERTZ with wifi
BMP61-W	146226	BMP61 Label Printer - QWERTY US with wifi
BMP61-QWERTY-EU-W	146227	BMP61 Label Printer - QWERTY EU with wifi
BMP61	146229	BMP61 Label Printer - QWERTY US
BMP61-QWERTY-EU	146230	BMP61 Label Printer - QWERTY EU
BMP61-AZERTY-EU-W	146231	BMP61 Label Printer - AZERTY with wifi
BMP61-QWERTZ-EU	148637	BMP61 Label Printer - QWERTZ
BMP61-AZERTY-EU	148638	BMP61 Label Printer - AZERTY
BMP61-QWERTY-UK	196453	BMP61 Label Printer - QWERTY UK
BMP61-QWERTY-UK-W	196454	BMP61 Label Printer - QWERTY UK with wifi
BMP61-CYRILLIC-W	196467	BMP61 Label Printer - CYRILLIC with wifi
BMP61-AZ-EU-W-PWID	198632	BMP61 Label Printer - AZERTY with wifi and Brady Workstation PWID Suite
BMP61-AZ-EU-PWID	198633	BMP61 Label Printer - AZERTY with Brady Workstation PWID Suite
BMP61-CYR-W-PWID	198634	BMP61 Label Printer - CYRILLIC with wifi and Brady Workstation PWID Suite
BMP61-QY-EU-W-PWID	198635	BMP61 Label Printer - QWERTY EU with wifi and Brady Workstation PWID Suite
BMP61-QY-EU-PWID	198636	BMP61 Label Printer - QWERTY EU with Brady Workstation PWID Suite
BMP61-QY-UK-W-PWID	198637	BMP61 Label Printer - QWERTY UK with wifi and Brady Workstation PWID Suite
BMP61-QY-UK-PWID	198638	BMP61 Label Printer - QWERTY UK with Brady Workstation PWID Suite
BMP61-QY-US-W-PWID	198639	BMP61 Label Printer - QWERTY US with wifi and Brady Workstation PWID Suite
BMP61-QY-US-PWID	198640	BMP61 Label Printer - QWERTY US with Brady Workstation PWID Suite
BMP61-QZ-EU-W-PWID	198641	BMP61 Label Printer - QWERTZ EU with wifi and Brady Workstation PWID Suite
BMP61-QZ-EU-PWID	198642	BMP61 Label Printer - QWERTZ EU with Brady Workstation PWID Suite

The Basic Suite is included with every printer, all you need to do is download it. [Workstation.BradyID.com/Free](http://Workstation.BradyID.com/Free)



For more information about the Brady Workstation Software Suites, see page 55.

### Data management versatility

- USB list feature: read spreadsheets directly from external USB-memory and integrate the data in your labels ready for printing
- Wifi-version available – compatible with mobile apps: create or load label templates with your smartphone and send them to your printer
- USB 2.0 ports (Type A & B) to copy large lists of label designs
- Works with LabelMark™ Labelling Software, Brady Mobile apps and Brady Workstation

## BMP61 ACCESSORIES

Art. No.	Description
018556	Printer cleaning kit
103788	USB Cable
114883	AC Adaptor - USA 120V
133255	Rechargeable NiMH Battery
146220	Hard Case for BMP61
146221	Magnet for BMP61
146233	Strap for BMP61
710612	AC Adaptor - Europe 220V
710613	AC Adaptor - UK 240V



## Printer Specifications

Language Support	Bulgarian, Croatian, Czech, Danish, Dutch, English, Estonian, Finnish, French, German, Hungarian, Italian, Norwegian (Bokmål), Polish, Portuguese, Romanian, Russian, Slovak, Slovenian, Spanish, Swedish, Turkish
Software Compatibility	Brady Workstation, Brady Mobile Apps, LabelMark
Bar Code Type	Code 39 and 128, other - such as QR - via software
Recommended Usage per Day	750 labels per day
Built-in Symbols	450 symbols included
Colour Capability	Monocolour
Stand-alone Printing (Detached from PC)	Stand-alone & Peripheral
Connectivity Options	USB 2.0, USB Flash Drive, Optional WiFi (factory installed)
Internal Memory Capacity	512MB of FLASH storage and 512MB of RAM
Print Speed (mm/sec)	33.8
Print Technology	Thermal Transfer
Print Resolution (dpi)	300
Smart Cell	Yes
Text Sizes (pt)	4 - 174 pt
Serialisation	Multiple & Linked
Max. Label Width (mm)	50.80
Max. Print Width (mm)	48.76 mm
Materials Supported	600+ standard parts: continuous tapes, die cut and bulk label rolls, custom made labels and tapes.
Keyboard Type	QWERTY, QWERTZ, AZERTY, CYRILLIC
Display	Colour Touchscreen
Cutter	Manual cut, Between labels or at end of print job
Power Supply	AC Adaptor, Rechargeable Battery
Height x Length x Width (mm)	106 mm x 328 mm x 107 mm
Weight (kg)	1.5



## BRADY WORKSTATION

Brady Workstation offers professional, intuitive apps to design quality product and cable labels and safety signs. With Brady Workstation label design becomes easier, faster and quickly adaptable to new label norms thanks to centralised updates.

For more information about the Brady Workstation Software Suites, see page 55.

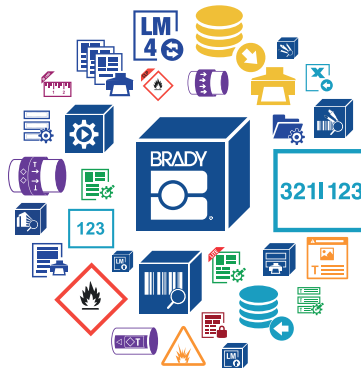

Straws & rods



Conical & Large Tube Labels



Centrifuge, Eppendorf & PCR labels

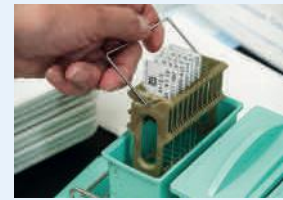

Slide Labels



Well Plate Labels



Cryo Labels



General Lab Equipment Labels



Removable Labels for Glassware



## BMP71 LABEL PRINTER

The BMP71 mobile label printer can print on more than 30 different types of label material including several which are specifically suitable for a laboratory environment - all designed with Brady's industrial strength durability.

- The powerful BMP71 prints faster than any other printer in its class (38 mm/sec). Don't wait longer than necessary for your labels.
- The BMP71 has a full keyboard, available in 4 versions, QWERTY, AZERTY, QWERTZ and CYRILLIC. Use both your hands to type your text instead of one finger and save you time!
- The enlarged colour screen of the BMP71 enables you to see the whole label at once, helping you to compose the label in the most efficient way, eliminating trial and error.
- The BMP71 printer is your essential tool that handles all your label printing needs

**One smart printer to print it all.**



### BMP71 LABEL PRINTER

Art. No.	Order Reference	Description
710601	BMP71-AZERTY-EU	BMP71 Label Printer with AZERTY Keyboard EU
710604	BMP71-CYRILLIC-EU	BMP71 Label Printer with CYRILLIC Keyboard-EU
710599	BMP71-QWERTY-EU	BMP71 Label Printer with QWERTY Keyboard - EU
710600	BMP71-QWERTY-UK	BMP71 Label Printer with QWERTY keyboard - UK
710603	BMP71-QWERTZ-EU	BMP71 Label Printer with QWERTZ Keyboard-EU

This printer kit ships in a hard case with Rechargeable NiMH Battery, AC Adaptor, USB Communications Cable, TLS2200® / HandiMark™ Material Roll Adaptor, Quick Start Guide, Product CD (w/ Printer Driver, Tutorials, Full User's Guide), Cleaning Kit, M71C-2000-595-WT, M71-31-423 and M71-R6000.

The Basic Suite is included with every printer, all you need to do is download it. [Workstation.BradlyID.com/Free](http://Workstation.BradlyID.com/Free)

**i** For more information about the Brady Workstation Software Suites, see page 55.

### BMP71 ACCESSORIES

Art. No.	Order Reference	Description
710613	M41/50/61/71-AC-BC-UK	AC Adaptor - UK 240V
710612	M41/50/61/71-BC-EU	AC Adaptor - Europe 220V
114883	M41/50/61/71-AC-BC-NA	AC Adaptor - USA 120V
710615	M71-QC-UK	Quick Charger - UK 240V
710614	M71-QC-EU	Quick Charger - Europe 220V
114884	M71-QC-US	Quick Charger - US 120V
114885	M71-BATT	Spare Battery
114882	M71-SC	Soft Carry Case
114881	M71-HC	Hard-sided Carry Case
114886	M71-CLEAN	Cleaning Kit
147998	M71-ADAPT-BK	Media Adaptor for BMP71 Printer

**i** **View online**

Visit [www.bradyeurope.com/BMP71](http://www.bradyeurope.com/BMP71) for more information on the BMP71 Label Printer.



## BBP™12 LABEL PRINTER

The BBP12 Label Printer is an entry level benchtop label printer for cable, component, product and laboratory sample identification that offers great value for money. The compact BBP12 offers a high print speed of 100 mm/second and can handle a wide range of highly durable and specialised Brady identification labels.

### Simple, Efficient Design

- Compact in size, fits on every desk
- Default Ethernet Connectivity, allowing you to work in a network
- Connect any universal keyboard via USB 2.0 to work in stand-alone mode
- Full colour LCD Display and intuitive software interface are simple to use, so no extensive training is required
- Simple calibration menu with easy 1-2-3 step printing
- Best price/quality in the market for low volume printing
- Comes with a free unwinder accessory to print larger label rolls

### Performance

- Prints a wide range of identification labels from 6 mm up to 112 mm wide
- Standard 300 dpi print quality allowing accurate image & barcode positioning on small labels
- With its powerful 32 bit processor and its extended memory it can print up to 100 mm / sec
- The printer supports the industry-standard Zebra® and Eltron® programming languages
- Print time and date on to your labels via the “Real time clock feature”



### VIEW ONLINE

Visit [www.bradyeurope.com/BBP12](http://www.bradyeurope.com/BBP12) for more information on the BBP12 Label Printer.



While the BBP12 label printer primarily uses 25.40 mm core materials for low to medium volume printing, an unwinder is available should high volume printing be needed.



For more information about the Brady Workstation Software Suites, see page 55.

## BBP12 LABEL PRINTER

Art. No.	Order Reference	Description
195566	BBP12-EU+Unwinder	BBP12 Label printer 300 dpi - EU with Unwinder
195567	BBP12-UK+Unwinder	BBP12 Label printer 300 dpi - UK with Unwinder
195568	BBP12-US+Unwinder	BBP12 Label printer 300 dpi - US with Unwinder
195966	BBP12-EU+U+Cutter	BBP12 Label printer 300 dpi - EU with Cutter and Unwinder
195967	BBP12-UK+U+Cutter	BBP12 Label printer 300 dpi - UK with Cutter and Unwinder
195968	BBP12-US+U+Cutter	BBP12 Label printer 300 dpi - US with Cutter and Unwinder
198595	BBP12-EU-U-PWID	BBP12 Label printer 300 dpi - EU with Unwinder and Brady Workstation PWID Suite
198600	BBP12-UK-U-PWID	BBP12 Label printer 300 dpi - UK with Unwinder and Brady Workstation PWID Suite
198602	BBP12-US-U-PWID	BBP12 Label printer 300 dpi - US with Unwinder and Brady Workstation PWID Suite

The Basic Suite is included with every printer, all you need to do is download it. [Workstation.BradylD.com/Free](http://Workstation.BradylD.com/Free)

## BBP12 PRINTER KITS

Art. No.	Description
198596	BBP12 Label printer 300 dpi - Laboratory Kit - EU
198597	BBP12 Label printer 300 dpi - Laboratory Kit - UK
198598	BBP12 Label printer 300 dpi - Laboratory Kit - US

This BBP12 label printer comes in a cardboard box. It ships with an unwinder, USB Cable, power cord, product CD, Quick Start Guide, Brady Workstation Product and Wire ID Suite, THT-131-461-3, THT-156-492-3, THT-163-499-3, R7950 35mmx70m /O, R6400 65mmx70m / O, R4900 65mmx70m /O

## ACCESSORY

Art. No.	Order Reference	Description
361064	BBP12/BBP11-VP	Peel and Present





## BBP™ 33 LABEL PRINTER

The BBP33 Label Printer is a completely hassle free, easy to use PC-based printer that can print signs and labels up to 101.60 mm wide. Smart chip supplies automatically set up the label in your Brady software, eliminating manual calibration and label waste. Drop-in ribbon and label cartridges ensure fast and effortless material changes. The BBP33 Label Printer can print on a full range of laboratory labels and provides you clear and durable labelling to eliminate errors in sample identification and ensure traceability.

- Eliminate errors in sample identification and ensure traceability with clear and durable labelling
- Fits best in your laboratory environment due to its small footprint
- Label materials withstand extreme conditions, including freezer storage, liquid nitrogen and hot water baths
- Automatic label setup with no calibration
- Fast and effortless material changeovers
- Prints correctly on the first label!

### **i** View online

Visit [www.bradyeurope.com/BBP33](http://www.bradyeurope.com/BBP33) for more information on the BBP33 Label Printer.



### BBP33 LABEL PRINTER

Article No.	Order Reference	Description
198603	BBP33-EU-PWID	BBP33 Label Printer - EU with Brady Workstation PWID Suite
198604	BBP33-EU-SFIDS	BBP33 Label Printer - EU with Brady Workstation SFID Suite
198605	BBP33-UK-PWID	BBP33 Label Printer - UK with Brady Workstation PWID Suite
198606	BBP33-UK-SFIDS	BBP33 Label Printer - UK with Brady Workstation SFID Suite
711071	BBP33 EU Printer	BBP33 Label Printer - EU
711075	BBP33 UK Printer	BBP33 Label Printer - UK

BBP33 Label Printer ships with printer, power cord, USB cable, drivers CD, cleaning kit and quick start guide.

The Basic Suite is included with every printer, all you need to do is download it. [Workstation.BradyID.com/Free](http://Workstation.BradyID.com/Free)

**i** For more information about the Brady Workstation Software Suites, see page 55.

### BBP33 ACCESSORIES

Article No.	Order Reference	Description
120994	B30-TROLLEY	Trolley for BBP30, BBP31 and BBP33
142114	B30-WIPER	Media Wiper 5 Pack
142116	B30-CCT	Cutter Cleaning Tool for BBP30, BBP31 and BBP33
142267	NET-LAN	LAN Network Card
142268	NET-WIFI-LAN	WiFi/ LAN Network Card

### LABORATORY STARTER KIT

Everything you need to identify your samples is included in the BBP33 Laboratory starter kit:

- BBP33 Label Printer: works well with materials and label sizes specifically developed for harsh lab environments, enabling sample traceability for life. A small printer footprint, compatibility with specific laboratory label materials, and excellent usability, make the BBP33 a label printer of choice for laboratories.
- cryo tube: B-492 FreezerBondz Labels are designed specifically to identify laboratory samples for cryo storage and can be applied to room temperature or already frozen samples
- vials, slides and straws: B-461 Labels are ideal to identify vials, centrifuge tubes, test tubes, straws and slides. They can resist freezer, autoclave and liquid nitrogen temperatures.
- well plates: B-423 labels are an excellent solution to identify well plates and other flat, glass surfaces. They can resist freezer and autoclave temperatures.
- 2 specialised ink ribbons
- Brady Workstation label design apps: professional, intuitive apps to design quality laboratory sample identification labels. With Brady Workstation label design becomes easier, faster and quickly adaptable to new label norms thanks to centralised updates.

Article No.	Order Ref.	Description
198527	BBP33-LAB KIT-EU	BBP33 Label Printer EU laboratory starter kit
198528	BBP33-LAB KIT-UK	BBP33 Label Printer UK laboratory starter kit

This BBP33 label printer kit comes in a cardboard box. It ships with a power cord, a USB cable, a drivers CD, a cleaning kit, a product CD, a quick start guide, 3 rolls of labels : B33-59-492, B33-17-423 and B33-133-461, 2 ribbons : B30-R6000HF and B30-R4300 and a Brady Workstation Product and Wire ID Suite CD.



## BradyPrinter i5100 INDUSTRIAL LABEL PRINTER

### The perfect mix of performance and smarts

The BradyPrinter i5100 Industrial Label Printer is smart and easy to use, offers excellent performance and prints over 1200 standard identification labels plus user specific, tailored custom labels.

#### Smart & connected

- Communicates automatically with our label design apps, label consumables and ink ribbons for a smooth and fast printer setup.
- Intuitive, full colour touch screen includes a label and print status monitor which also informs you when the installed ink ribbon does not optimally match the inserted label supplies.
- Brady labels can easily be loaded thanks to a self-centering roll holder and automatic calibration and label setup.
- The printer features a range of standard ports for common industrial connectivity scenarios.

#### Excellent print performance

- With 300 and 600 dpi printing, the BradyPrinter i5100 offers crisp, high quality printing on reliable, industrial grade labels from 5 up to 110 mm.
- Driven by a powerful 32 bit and 800 Mhz internal printer processor, the i5100 prints at a speed of up to 300 mm/sec at 300 dpi.
- The printer's interchangeable platen rollers help to keep its performance at maximum, even after intensive use.

#### Reliable, industrial grade labels

- The BradyPrinter i5100 can print on 70 label materials, more than 1200 stock label parts and tailored custom label materials and parts.
- Laboratory labels: cryo tube labels, slide labels, removable glassware labels, well plate labels, tissue cassette labels a.o.



#### View online

Consult the videos of the i5100 BradyPrinter on:  
[www.bradyeurope.com/i5100](http://www.bradyeurope.com/i5100)

Article No.	Order Reference	Description
<b>300 DPI</b>		
149458	i5100-300-UKEU	BradyPrinter i5100 300 dpi - UK/EU
149459	i5100-300-C-UKEU	BradyPrinter i5100 300 dpi - UK/EU with Cutter
198766	i5100-300-US	BradyPrinter i5100 300 dpi - US
198767	i5100-300-C-US	BradyPrinter i5100 300 dpi - US with Cutter
198772	i5100-300-US-PWID	BradyPrinter i5100 300 dpi - US with Brady Workstation PWID Suite
198773	i5100-300C-US-PWID	BradyPrinter i5100 300 dpi - US with Cutter and Brady Workstation PWID Suite
198778	i5100-300-EU-PWID	BradyPrinter i5100 300 dpi - UK/EU with Brady Workstation PWID Suite
198779	i5100-300C-EU-PWID	BradyPrinter i5100 300 dpi - UK/EU with Cutter and Brady Workstation PWID Suite
<b>600 DPI</b>		
149461	i5100-600-UKEU	BradyPrinter i5100 600 dpi - UK/EU
149462	i5100-600-C-UKEU	BradyPrinter i5100 600 dpi - UK/EU with Cutter
198768	i5100-600-US	BradyPrinter i5100 600 dpi - US
198769	i5100-600-C-US	BradyPrinter i5100 600 dpi - US with Cutter
198774	i5100-600-US-PWID	BradyPrinter i5100 600 dpi - US with Brady Workstation PWID Suite
198775	i5100-600C-US-PWID	BradyPrinter i5100 600 dpi - US with Cutter and Brady Workstation PWID Suite
198780	i5100-600-EU-PWID	BradyPrinter i5100 600 dpi - UK/EU with Brady Workstation PWID Suite
198781	i5100-600C-EU-PWID	BradyPrinter i5100 600 dpi - UK/EU with Cutter and Brady Workstation PWID Suite

### ACCESSORIES

Article No.	Order Ref.	Description
133251	PCK-6	Printer Cleaning Kit - Thermal Transfer Printers
149080	BT-USB-ADAPT	Bluetooth USB Adapter
149131	WLAN-EXANT	USB Wlan Stick with External Antenna
149470	i5100-IP-HOLDER	RFID enabled Media Roll Holder
149471	i5100-PR-120mm	i5100 120mm Platen Roller
149472	i5100-PR-25mm	i5100 25mm Platen Roller
149473	i5100-PR-50mm	i5100 50mm Platen Roller
149562	i5100-IP-RIBBTUP	Ribbon Takeup Spindle
149598	i5100-PR-80mm	i5100 80mm Platen Roller
197823	SD-CARD-8GB	SD Memory card 8GB
711019	RS232 C 9/9-pin 3m	Cable RS232 C, 9/9-pin, 3m







## BradyPrinter i7100

INDUSTRIAL LABEL PRINTER

### When accuracy meets precision

The BradyPrinter i7100 Industrial Label Printer offers durable and highly accurate label printing for business critical high volume identification challenges in Aerospace, Defence, Mass Transit, Electronics, Automotive and Logistics industries. Quickly print a wide range of high quality identification materials for a variety of applications including cable, printed circuit board and asset & component identification.

### Reliable & fast precision printing

The BradyPrinter i7100 offers highly accurate label printing for business critical high volume identification challenges.

The printer features:

- a powerful internal processor designed to handle up to 7000 labels per day
- up to 300 mm/sec print speed
- 600 dpi ultra-sharp printing
- centre alignment of prints for high printing accuracy
- interchangeable platen rollers for optimised printhead life time
- a wide range of high quality identification materials



### View online

Visit [www.bradyeurope.com/i7100](http://www.bradyeurope.com/i7100) for more information on the BradyPrinter i7100.

### Easy to use

The BradyPrinter i7100 has an intuitive colour touch screen interface with distinctive icons to easily access the printer's menus. The printer's foldable cover allows for a small system footprint and enables users to quickly change consumables to start a new job or continue printing.

## BRADY WORKSTATION

Brady Workstation offers professional, intuitive apps to design quality product and cable labels and safety signs. With Brady Workstation label design becomes easier, faster and quickly adaptable to new label norms thanks to centralised updates.

For more information about the Brady Workstation Software Suites, see page 55.



# BradyPrinter i7100 Industrial Label Printer

Printer Specifications	
<b>Description</b>	BradyPrinter i7100 Industrial Label Printer
<b>Includes</b>	This i7100 printer comes in a cardboard box. It ships with a power cord, 2 empty ribbon cores, a USB cable, a product CD holding the driver, the user manual in languages, the configuration/settings manual in English, a printed user manual in English and a Brady Workstation Basic Suite or a Brady Workstation PWID Suite
<b>Applications</b>	General & Industrial Identification; Circuit Board & Component Identification; Wire & Cable Marking; Laboratory Identification
<b>Print Speed (mm/sec)</b>	up to 300
<b>Internal Memory</b>	256MB RAM, 50MB IFFS Flash, SD card, slot up to 512GB
<b>Software Compatibility</b>	Brady Workstation, LabelMark, Windows based driver for 3rd party software use, CodeSoft
<b>Recommended Usage per Day</b>	7000
<b>Colour Capability</b>	Monocolour
<b>Language Support</b>	Arabic (Egypt), Bulgarian, Croatian, Czech, Danish, Dutch, English, Finnish, French, German, Greek, Hungarian, Italian, Lithuanian, Macedonian, Norwegian (Bokmål), Persian (Farsi), Polish, Portuguese, Romanian, Russian, Serbian, Slovenian, Spanish, Swedish, Turkish
<b>Weight (kg)</b>	10
<b>Size W x H x D (mm)</b>	252 x 288 x 460
<b>Max. Label Width (mm)</b>	110 mm
<b>Min. Label Width (mm)</b>	4 mm
<b>Max. Liner Width (mm)</b>	114 mm
<b>Min. Liner Width (mm)</b>	9 mm
<b>Max. Print Width (mm)</b>	105.7 mm
<b>Warranty</b>	2 years

Article No.	Order Reference	Description
<b>300 dpi</b>		
149046	i7100-300-EU	BradyPrinter i7100 300 dpi - EU
198607	i7100-300-EU-PWID	BradyPrinter i7100 300 dpi - EU with Brady Workstation PWID Suite
149049	i7100-300-P-EU	BradyPrinter i7100 300 dpi - EU with Peel function
198608	i7100-300P-EU-PWID	BradyPrinter i7100 300 dpi - EU with Peel function and Brady Workstation PWID Suite
149067	i7100-300-UK	BradyPrinter i7100 300 dpi - UK
198611	i7100-300-UK-PWID	BradyPrinter i7100 300 dpi - UK with Brady Workstation PWID Suite
149068	i7100-300-P-UK	BradyPrinter i7100 300 dpi - UK with Peel function
198609	i7100-300P-UK-PWID	BradyPrinter i7100 300 dpi - UK with Peel function and Brady Workstation PWID Suite
197690	i7100-300-US	BradyPrinter i7100 300 dpi - US
198612	i7100-300-US-PWID	BradyPrinter i7100 300 dpi - US with Brady Workstation PWID Suite
197689	i7100-300-P-US	BradyPrinter i7100 300 dpi - US with Peel function
198610	i7100-300P-US-PWID	BradyPrinter i7100 300 dpi - US with Peel function and Brady Workstation PWID Suite
<b>600 dpi</b>		
149047	i7100-600-EU	BradyPrinter i7100 600 dpi - EU
198613	i7100-600-EU-PWID	BradyPrinter i7100 600 dpi - EU with Brady Workstation PWID suite
149052	i7100-600-P-EU	BradyPrinter i7100 600 dpi - EU with Peel function
198614	i7100-600P-EU-PWID	BradyPrinter i7100 600 dpi - EU with Peel function and Brady Workstation PWID Suite
149066	i7100-600-UK	BradyPrinter i7100 600 dpi - UK
198617	i7100-600-UK-PWID	BradyPrinter i7100 600 dpi - UK with Brady Workstation PWID Suite
149065	i7100-600-P-UK	BradyPrinter i7100 600 dpi - UK with Peel function
198615	i7100-600P-UK-PWID	BradyPrinter i7100 600 dpi - UK with Peel function and Brady Workstation PWID Suite
197692	i7100-600-US	BradyPrinter i7100 600 dpi - US
198618	i7100-600-US-PWID	BradyPrinter i7100 600 dpi - US with Brady Workstation PWID Suite
197691	i7100-600-P-US	BradyPrinter i7100 600 dpi - US with Peel function
198616	i7100-600P-US-PWID	BradyPrinter i7100 600 dpi - US with Peel function with Brady Workstation PWID Suite

The Basic Suite is included with every printer, all you need to do is download it. [Workstation.BradyID.com/Free](http://Workstation.BradyID.com/Free)

**i** For more information about the Brady Workstation Software Suites, see page 55.

## INTERFACES ON THE BACK OF THE DEVICE

SD Memory Card Slot

2 x USB Host Interface Ports

USB 2.0 High-Speed Device for PC Connection

Ethernet 10/100 BASE-T Port

I/O Interface Connection (standard on peel model, optional on non-peel model)



## BRADYPRINTER i7100 ACCESSORIES

Article No.	Order Reference	Description
133251	PCK-6	Printer Cleaning Kit - Thermal Transfer Printers
149043	i7100-PR-120mm	120mm Platen Roller with synthetic rubber coating
149044	i7100-PRS-120mm	120mm Platen Roller with silicone rubber coating
149048	i7100-PR-25mm	25mm Platen Roller with synthetic rubber coating
149051	i7100-RAR-120mm	120mm Rewind Assist Roller with synthetic rubber coating
149054	i7100-PR-80mm	80mm Platen Roller with synthetic rubber coating
149055	i7100-PR-50mm	50mm Platen Roller with synthetic rubber coating
149069	i7100-CUTTER+TRAY	Cutter CU400 with Tray
149070	i7100-ANTI-S-BRUSH	Antistatic Brush
149071	i7100-IO-LABEL-BOX	Label Selection I/O Box
149072	i7100-PS1000MP	Present Sensor PS1000MP
149073	i7100-IO-CONNECTOR	I/O Interface Connector SUB-D 25pins
149074	i7100-RG400-PLATE	Rewind Guide Plate RG400
149075	i7100-PS900	Present Sensor PS900
149077	i7100-IO-INTERFACE	I/O Interface
149078	i7100-PERF-CUTTER	Perforation Cutter PCU400
149080	BT-USB-ADAPT	Bluetooth USB Adapter
149131	WLAN-EXANT	USB Wlan Stick with External Antenna
149132	i7100-ADAPTER-100	i7100 Adapter for 100mm Core
149135	i7100-PPLTEXT-410	i7100 Extended Peel off plate DP410
149207	i7100-TEAR-OFF	i7100 Tear off Plate
149208	i7100-HEX-KEY-TOOL	i7100 Spare Hex Key Tool
197823	SD-CARD-8GB	SD Memory card 8GB





## BSP™ 31 LABEL ATTACHMENT SYSTEM

- Brady has developed a unique set of products for the histology and anatomic pathology market in order to guarantee pre-process identification for tissue samples allowing traceability throughout laboratory processes as well as long term storage (< 20 years).
- The BSP31 Label Attachment System is designed to mechanically fasten an adhesive label to a tissue cassette before the tissue embedding process. This easy-to-use unit creates rivets on the label which prevent the label from detaching during the embedding process or during long-term storage
- When a cassette is inserted into the front of the unit, a clamp automatically grabs the cassette. In less than a minute, four small heat probes pierce through the label and front plastic of the cassette. Heat applied to the probes melts the cassette plastic and forms rivets on the label. When the unit retracts the probes from the cassette, the cassette is released and the user can remove it and place the biospecimen onto the cassette.
- The BSP31 unit must be used exclusively with Brady B-482 label material and the R6400 thermal transfer printer ribbon.

Art. No.	Order Reference	Description
804850	BSP31 LABEL ATTACHMENT SYSTEM EUROPE	BSP31 Label Attachment System - EU/UK
804855	BSP31-KIT LIGHT EUR	BSP31 Label Attachment System Light Kit - EU
804856	BSP31-KIT LIGHT UK	BSP31 Label Attachment System Light Kit - UK
804858	BSP31-KIT FULL EUR	BSP31 Label Attachment System Full Kit - EU
804859	BSP31-KIT FULL UK	BSP31 Label Attachment System Full Kit - UK
114631	BRUSH KIT,BSP31	Cleaning Brushes for the BSP31
804866	ASSY FILTER BSP31 RC	Filter for the BSP31

Light Kit: BSP31 Label Attachment System, BBP12 300 dpi Printer and a Brady Workstation Basic Suite  
 Full Kit: BSP31 Label Attachment System, BBP12 300 dpi Printer, a Brady Workstation Basic Suite, a CR1400 bar code reader with 1.83 m USB cable, Thermal Transfer Printable Labels BPT-164-481 & THT-199-482-3-SC, Black Thermal Transfer Printer Ribbon R6400 65mm x 70m /0



### B-482 Tissue cassette labels

“We have received very positive feedback on the Brady cassette labels from researchers. They report that, as well as looking much more professional, the printed labels save time when they need to search through their archived blocks for a particular sample. Black text printed on a white label is very much quicker and easier to read than pencil on a green cassette. The clear labels therefore eliminate any confusion or mistakes which could occur with handwritten data.”

**Cardiff University – School of Biosciences, UK**



## BRADY WORKSTATION SOFTWARE SUITES

Brady Workstation offers professional, intuitive apps to design quality product and cable labels and safety signs. Label design becomes easier, faster and quickly adaptable to new label norms thanks to centralised updates.

### Select the apps you need

Simply select the apps you need, download the 30-day trial and purchase when satisfied. Here are just a few of the sample containers included in Brady Workstation:

- Cryovials
- Slides
- Tissue Cassettes
- Well Plates
- Centrifuge tubes

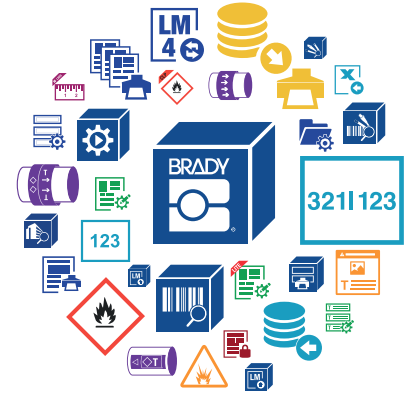

### BRADY WORKSTATION BASIC DESIGN SOFTWARE SUITE

Get everyone in your facility up and running quickly on as many computers as you like with this free label creation software! You'll have basic design, formatting, graphics and simple barcode libraries to create labels like a pro!

The Basic Suite is included with every printer, all you need to do is download it. [Workstation.BradyID.com/Free](http://Workstation.BradyID.com/Free)



Try it today! Discover Brady Workstation at [www.bradyeurope.com/workstation](http://www.bradyeurope.com/workstation) or download at [workstation.bradyid.com](http://workstation.bradyid.com).



### BRADY WORKSTATION PRODUCT AND WIRE IDENTIFICATION SOFTWARE SUITE

Quickly identify your products and wires with customised text or graphical labels, using serialised or imported data. [Workstation.BradyID.com/ProductandWire](http://Workstation.BradyID.com/ProductandWire)



### BRADY WORKSTATION SAFETY AND FACILITY IDENTIFICATION SOFTWARE SUITE

Keep your facility safe and compliant by creating custom signs, label and pipemarkers, adding visual safety guidance. [Workstation.BradyID.com/SafetyAndFacility](http://Workstation.BradyID.com/SafetyAndFacility)



### BRADY WORKSTATION DATA AUTOMATION

Use the Brady Workstation Data Automation app to set up automated sample label printing using information from a LIMS. Data Automation uses Brady Workstation label templates and .csv – exports from an ERP system such as LIMS. It enables the setup of several print channels that send preselected information to a predetermined label template which can be printed on a printer of choice, loaded with the correct consumables. Once set up, Data Automation can automatically print a sample label when a LIMS receives information on a newly arrived sample.

## CODESOFT™ LABEL CREATION SOFTWARE

CodeSoft is a very powerful, feature-rich design software. It has the most text editing and bar code features, plus it is the best choice for advanced database importation and integration with 3rd party software programs - like LIMS.

- Over 100 Bar code symbologies including linear and 2D
- Robust data sourcing capabilities
- View labels and data in the same screen
- Label Comparison tool for previewing labels at design or production stages
- OLE automation supports object integration from any 3rd party Windows® application
- Enhanced Shape Tool makes using graphics and shapes on your labels a snap
- CodeSoft Pro - is for users printing text, images and bar codes on one to three printers
- CodeSoft Enterprise - is for user printing from databases and existing systems
- CodeSoft Network - is for users who want to manage licenses from a server





Brady offers a range of easy-to-use, high density scanners with superior imaging technology (Adaptus) that enable :

- fast and efficient scanning of any barcode, 2D-code or QR-code on a range of surfaces
- optimal handling thanks to a light weight and small size
- durable and reliable, stays intact in drop tests when falling from up to 1.8 m.







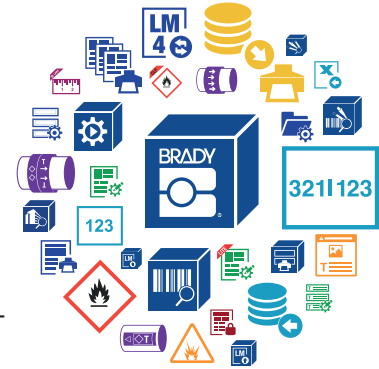

## BRADY WORKSTATION

In order to achieve full track & trace control, you can use Brady Workstation apps to quickly design labels, import data from ERP or LIMS-systems, add QR-codes, barcodes or other 2D-codes, serialise and hit print. When printed with the specialised inks of a Brady printer, our label materials can identify items throughout complete production cycles and in storage much more effectively and much longer than any non-specialised solution.



## LINEAR VS. 2-DIMENSIONAL BAR CODES

7 mil Examples	10 mil Examples	Symbol Size (mm) Row x Column	Bar Code Data Capacity		Built-in Error Correction
			Numeric	Alphanumeric	
 3.43 mm / 2D / Data Matrix Bar Code	 4.57 mm / 2D / Data Matrix Bar Code	18 x 18	36	25	YES (ECC200)
 4.95 mm / 2D / Data Matrix Bar Code	 6.60 mm / 2D / Data Matrix Bar Code	26 x 26	88	64	YES (ECC200)
 25.40 mm / Linear / Code 128 Bar Code	 31.75 mm / Linear / Code 128 Bar Code	31.75	10	10	NO



## WIRED SCANNER VOYAGER 1250

Optimised for fast scanning of linear bar codes, including poorly printed and damaged codes, the Voyager 1250g enables enterprises to minimise manual data entry, leading to increased productivity and reduction in errors.

- 1D barcodes
- Laser technology
- Read barcodes up to 44.7 cm away
- Ergonomic design
- IP40 rated



Article No.	Description
197614	Honeywell Voyager 1250g handheld scanner

## WIRED SCANNER XENON 1900 HD

Powered by sixth-generation Adaptus™ imaging technology, the Xenon 1900g scanner delivers superior barcode scanning and digital image capture. The scanner incorporates a revolutionary decoding architecture and a custom sensor, enabling extended depth of field, faster reading and improved scanning performance on poor-quality barcodes. From high-density linear to 2D barcodes found directly on the screen of a mobile device, the Xenon 1900g scanner decodes virtually all barcodes with ease.

- High Definition Focus
- 1D and 2D barcodes
- Drop resistance to 1.8 m
- Integrated Adaptus Imaging technology :
  - Extended depth of field
  - Faster barcode reading
  - Improved scanning performance on poor quality barcodes
- IP41 rated
- Disinfectant-ready housing for Healthcare

Article No.	Description
197611	Xenon 1900H HD

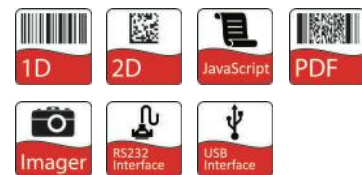

## WIRELESS SCANNER XENON 1902 HD

Powered by Adaptus® Imaging Technology 6.0, the wireless area-imaging scanner Xenon 1902 delivers superior bar code scanning and digital image capture. Xenon 1902 incorporates a revolutionary decoding architecture and a custom sensor, enabling extended depth of field, faster reading, and improved scanning performance on poor quality bar codes. From high density linear to 2D bar codes found directly on the screen of a mobile device, Xenon 1902 decodes virtually all bar codes with ease. Xenon 1902 incorporates a Bluetooth Class 2, v2.1 radio, enabling unrestricted movement up to 10m from the base, and a battery that provides up to 14 hours of battery life. For added convenience, a paging system helps locate misplaced scanners.

- High Definition Focus
- 1D and 2D barcodes
- Bluetooth Class 2
- Long-lasting lithium-ion battery
- Drop resistance to 1.8 m
- Integrated Adaptus Imaging technology :
  - Extended depth of field
  - Faster barcode reading
  - Improved scanning performance on poor quality barcodes
- IP41 rated
- Disinfectant-ready housing for Healthcare

Article No.	Description
197613	Xenon 1902H HD



The Code Reader™ scanners are still available. Contact your local Brady Distributor or Brady Customer Service for ordering information.



# Brady Laboratory Printers Online



Surfing [www.bradyeurope.com](http://www.bradyeurope.com) is a simple, efficient and timesaving way to learn more about BRADY products and applications, industry developments, events, promotions, etc.



Visit [www.bradyeurope.com](http://www.bradyeurope.com) to find technical data sheets, update your Brady printers and software or quickly register Brady products!

For more information on featured printers visit: [www.youtube.com/BradyEurope](http://www.youtube.com/BradyEurope)



**BMP™ 21-LAB**  
LABEL PRINTER



**BMP 51**  
LABEL PRINTER



**BMP 61**  
LABEL PRINTER



**BMP 71**  
LABEL PRINTER



**BBP™ 12**  
LABEL PRINTER



**BBP™ 33**  
LABEL PRINTER



**BradyPrinter i5100**  
INDUSTRIAL LABEL PRINTER



**BradyPrinter i7100**  
INDUSTRIAL LABEL PRINTER



**BSP™ 31**  
LABEL ATTACHMENT SYSTEM

## See Your Printer Of Choice In Action

Experience live how the printer works in the hands-on printer demo at your premises, or watch how it operates via a live feed.

Discuss with our specialist how the printer will support you in your specific context to choose the system that best suits your needs.

[www.bradyeurope.com](http://www.bradyeurope.com)



### REGISTER YOUR PRODUCT

After registering your product you will have access to:

- Technical support
- Notification of updates
- Special offers and product announcements

[www.bradyeurope.com/registration](http://www.bradyeurope.com/registration)







## Miscellaneous Products

Hazardous Substance Identification .....	60
Sorbent Products .....	62
Pipemarkers .....	66
Safety Signs on Rolls .....	66

## ALL CHEMICALS LABELLED?

CLP is a mandatory European Union regulation which requires, amongst other obligations, the clear identification of products containing dangerous chemicals.

The EU's CLP regulation is based on the United Nation's Globally Harmonised System for chemical substances and, from June 2015 onwards, compliance to CLP is required for dangerous chemicals and mixtures in all EU member states. Every substance listed as dangerous, and every mix containing one of these dangerous substances, also needs to carry a CLP label as of June 2015.



## WHAT IS CLP?

Classification, Labelling and Packaging (CLP) of substances and mixtures is the EU Regulation 1272/2008 which is an EU-wide system for classifying and labelling chemicals.

The system adopts the United Nations' Globally Harmonised System, or GHS.

- The GHS/CLP symbols were introduced in the EU on the basis of the CLP/GHS regulation (Classification, Labelling and Packaging) in January 2009.
- **GHS/CLP replaces the HSID labelling:** The orange coloured hazardous materials pictograms used until now are being replaced with new diamond-shaped pictograms on a white background with a red border. The current R+S Statements are replaced by H+P Statements (+ EUH Statements). In the EU, it has been required since 01.12.2010 to label **chemical substances** in accordance with the regulation. As from 01.06.2015 this requirement also applies to **chemical mixtures**. In the CLP/GHS the signal words "Danger and "Warning must be used, in accordance with the substance.

## WHY DOES GHS MATTER?

**Chemical import/export means big business**

Globally, the production and use of chemicals is a more than 1.5 trillion € per year enterprise (340€ billion in the U.S. alone). Chemical labelling has appeared differently based on different regional requirements. With such an impact on the world economy, it's critical that the import and export of chemicals be made as safe and efficient as possible.

The GHS standard globally helps keep workers safe and informed of chemical hazards.

## PRE-PRINTED LABELS WITH CLP/GHS SYMBOLS

Brady has a wide range of pre-printed labels to identify your chemical containers.

- High quality labels that can withstand the toughest environments
- Ultra-durable materials mean you only need to label products once in their lifetime
- Extremely weather, abrasion and chemical resistant
- Labels can withstand temperatures of -40 °C to +120 °C

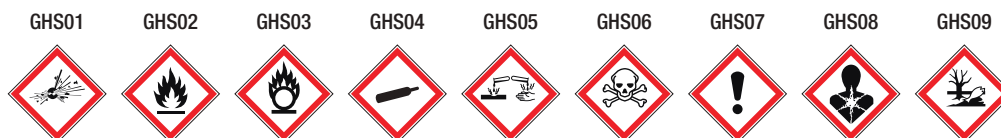

Width x Height	Layout	PIC 1801	PIC 1802	PIC 1803	PIC 1804	PIC 1808	PIC 1809	PIC 1805	PIC 1807	PIC 1806
		Explosive	Flammable	Oxidizing	Compressed Gas	Corrosive	Acute Toxicity	Health Hazard	Respiratory Hazard	Hazardous to Aquatic Environment
50 mm x 50 mm	Continuous Roll	811681	811686	811691	811696	811716	811721	811701	811711	811706
50 mm x 50 mm	Individual Markers on a Roll	814032	814033	814034	814035	814039	814040	814036	814038	814037
100 mm x 100 mm	Continuous Roll	814023	814024	814025	814026	814030	814031	814027	814029	814028
100 mm x 100 mm	Individual Markers on a Roll	811679	811684	811689	811694	811714	811719	811699	811709	811704

## PRE-PRINTED GHS/CLP CHEMICAL LABELS

PRINT 2 COLOUR GHS LABELS IN ONE FAST PRINT PASS!

- Blank labels with pre-printed red diamonds allow printer to produce 2 colour GHS/CLP labels in one print pass
- 3 sizes of labels, each with 6 different diamond layouts that match templates in Brady Workstation. Visit [www.bradyeurope.com](http://www.bradyeurope.com) or contact your Brady distributor for more information
- Indoor/outdoor vinyl material withstands exposure to moisture, chemicals and handling



### Pre-printed GHS/CLP Labels for BBP12 Label Printer

Diagram	Order Reference	Layout	Label Width A (mm)	Label Height B (mm)	Vertical Repeat D (mm)	Web Width E (mm)	Labels per Row	Labels per Package	Ribbon Series
<b>B-7610: Paper</b>									
▲	THTCLP-S-L1-7610-0.4-SC	L1	55.00	85.00	91.02	59.00	1	400	R7950
▲	THTCLP-S-L2-7610-0.4-SC	L2	55.00	85.00	91.02	59.00	1	400	R7950
▲	THTCLP-S-L3A-7610-0.4-SC	L3A	55.00	85.00	91.02	59.00	1	400	R7950
▲	THTCLP-S-L3B-7610-0.4-SC	L3B	55.00	85.00	91.02	59.00	1	400	R7950
▲	THTCLP-S-L4A-7610-0.4-SC	L4A	55.00	85.00	91.02	59.00	1	400	R7950
▲	THTCLP-S-L4B-7610-0.4-SC	L4B	55.00	85.00	91.02	59.00	1	400	R7950
▲	THTCLP-M-L1-7610-0.3-SC	L1	75.00	110.00	115.36	79.00	1	300	R7950
▲	THTCLP-M-L2-7610-0.3-SC	L2	75.00	110.00	115.36	79.00	1	300	R7950
▲	THTCLP-M-L3A-7610-0.3-SC	L3A	75.00	110.00	115.36	79.00	1	300	R7950
▲	THTCLP-M-L3B-7610-0.3-SC	L3B	75.00	110.00	115.36	79.00	1	300	R7950
▲	THTCLP-M-L4A-7610-0.3-SC	L4A	75.00	110.00	115.36	79.00	1	300	R7950
▲	THTCLP-M-L4B-7610-0.3-SC	L4B	75.00	110.00	115.36	79.00	1	300	R7950
▲	THTCLP-L-L1-7610-0.2-SC	L1	105.00	155.00	160.12	109.00	1	200	R7950
▲	THTCLP-L-L2-7610-0.2-SC	L2	105.00	155.00	160.12	109.00	1	200	R7950
▲	THTCLP-L-L3A-7610-0.2-SC	L3A	105.00	155.00	160.12	109.00	1	200	R7950
▲	THTCLP-L-L3B-7610-0.2-SC	L3B	105.00	155.00	160.12	109.00	1	200	R7950
▲	THTCLP-L-L4A-7610-0.2-SC	L4A	105.00	155.00	160.12	109.00	1	200	R7950
▲	THTCLP-L-L4B-7610-0.2-SC	L4B	105.00	155.00	160.12	109.00	1	200	R7950
<b>B-7594: Polypropylene</b>									
▲	THTCLP-S-L1-7594-0.4-SC	L1	55.00	85.00	91.02	59.00	1	400	R6000HF
▲	THTCLP-S-L2-7594-0.4-SC	L2	55.00	85.00	91.02	59.00	1	400	R6000HF
▲	THTCLP-S-L3A-7594-0.4-SC	L3A	55.00	85.00	91.02	59.00	1	400	R6000HF
▲	THTCLP-S-L3B-7594-0.4-SC	L3B	55.00	85.00	91.02	59.00	1	400	R6000HF
▲	THTCLP-S-L4A-7594-0.4-SC	L4A	55.00	85.00	91.02	59.00	1	400	R6000HF
▲	THTCLP-S-L4B-7594-0.4-SC	L4B	55.00	85.00	91.02	59.00	1	400	R6000HF
▲	THTCLP-M-L1-7594-0.3-SC	L1	75.00	110.00	115.36	79.00	1	300	R6000HF
▲	THTCLP-M-L2-7594-0.3-SC	L2	75.00	110.00	115.36	79.00	1	300	R6000HF
▲	THTCLP-M-L3A-7594-0.3-SC	L3A	75.00	110.00	115.36	79.00	1	300	R6000HF
▲	THTCLP-M-L3B-7594-0.3-SC	L3B	75.00	110.00	115.36	79.00	1	300	R6000HF
▲	THTCLP-M-L4A-7594-0.3-SC	L4A	75.00	110.00	115.36	79.00	1	300	R6000HF
▲	THTCLP-M-L4B-7594-0.3-SC	L4B	75.00	110.00	115.36	79.00	1	300	R6000HF
▲	THTCLP-L-L1-7594-0.2-SC	L1	105.00	155.00	160.12	109.00	1	200	R6000HF
▲	THTCLP-L-L2-7594-0.2-SC	L2	105.00	155.00	160.12	109.00	1	200	R6000HF
▲	THTCLP-L-L3A-7594-0.2-SC	L3A	105.00	155.00	160.12	109.00	1	200	R6000HF
▲	THTCLP-L-L3B-7594-0.2-SC	L3B	105.00	155.00	160.12	109.00	1	200	R6000HF
▲	THTCLP-L-L4A-7594-0.2-SC	L4A	105.00	155.00	160.12	109.00	1	200	R6000HF
▲	THTCLP-L-L4B-7594-0.2-SC	L4B	105.00	155.00	160.12	109.00	1	200	R6000HF

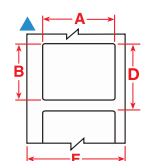

L1



L2



L3A



L3B



L4A

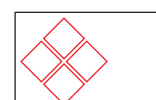

L4B

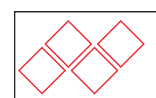

L4C

### Pre-printed GHS/CLP Labels for BBP33 Label Printer

Diagram	Order Reference	Layout	Label Width A (mm)	Label Height B (mm)	Labels per Row	Labels per Package	Ribbon Series
<b>B-7569: Vinyl</b>							
▲	B30-260-7569-CLP1	L1	55.00	85.00	1	340	B30-R10000
▲	B30-260-7569-CLP2	L2	55.00	85.00	1	340	B30-R10000
▲	B30-260-7569-CLP3A	L3A	55.00	85.00	1	340	B30-R10000
▲	B30-260-7569-CLP3B	L3B	55.00	85.00	1	340	B30-R10000
▲	B30-260-7569-CLP4A	L4A	55.00	85.00	1	340	B30-R10000
▲	B30-260-7569-CLP4B	L4B	55.00	85.00	1	340	B30-R10000
▲	B30-261-7569-CLP1	L1	75.00	110.00	1	270	B30-R10000
▲	B30-261-7569-CLP2	L2	75.00	110.00	1	270	B30-R10000
▲	B30-261-7569-CLP3A	L3A	75.00	110.00	1	270	B30-R10000
▲	B30-261-7569-CLP3B	L3B	75.00	110.00	1	270	B30-R10000
▲	B30-261-7569-CLP4A	L4A	75.00	110.00	1	270	B30-R10000
▲	B30-261-7569-CLP4B	L4B	75.00	110.00	1	270	B30-R10000
▲	B30-18-7569-CLP4C	L4C	76.20	25.40	1	1000	B30-R10000
▲	B30-262-7569-CLP1	L1	105.00	155.00	1	200	B30-R10000
▲	B30-262-7569-CLP2	L2	105.00	155.00	1	200	B30-R10000
▲	B30-262-7569-CLP3A	L3A	105.00	155.00	1	200	B30-R10000
▲	B30-262-7569-CLP3B	L3B	105.00	155.00	1	200	B30-R10000
▲	B30-262-7569-CLP4A	L4A	105.00	155.00	1	200	B30-R10000
▲	B30-262-7569-CLP4B	L4B	105.00	155.00	1	200	B30-R10000

## LAB PACK

- Ideal for medium sized spills.
- Water and chemical resistant drum protects sorbents.
- Easy access to products thanks to screw top lid.
- Drum can be used as shipping container for used sorbents.

**Kit contains:** 12 pads (41 cm x 51 cm), 3 socks (Ø 7.6 cm x 366 cm), 2 pillows (43 cm x 48 cm), 1 pair of gloves, 1 pair of goggles and 3 disposal bags.



Order Reference	Article No.	Description	Quantity	Absorption Capacity (Ltrs)
SKO-20	813869	LAB PACK, Oil Only	1 Kit	59
SKA-20	813870	LAB PACK, Maintenance	1 Kit	59
SKH-20	813871	LAB PACK, Chemical	1 Kit	57
SKR-20	813959	Re-Form Lab Pack - Maintenance	1 Kit	65

## SPC SPILL BOX - PADS IN A CONVENIENT DISPENSER BOX ALLOWING YOU TO CREATE MULTIPLE SPILL STATIONS AROUND YOUR SITE!



- Reusable plastic box can be refilled once all the sorbents have been used.
- The Spill Box is light enough to be hung to laboratory and storage area walls or to be attached to a forklift.
- The bright yellow colour stands out for quick identification and use.
- Various application areas: in liquid storage areas, behind the seat of a truck, lab environments, in workstations that deal with liquids.

Order Reference	Article No.	Description	Total Qty/Pack
SA-SBA	813909	SPILL BOX, Maintenance, filled box with 15 pads	15 Pad(s) / Kit
SA-SBH	813910	SPILL BOX, Chemical, filled box with 10 pads	10 Pad(s) / Box



## SPILL RESPONSE PLUS

Spill Response Plus is a smaller size pad and roll designed to be highly absorbent, durable, low lint and to reduce waste.

- Dimpled design provides better looking, strong and durable product
- Roll is perforated so you only use what you need
- Includes universal (grey) and chemical (green) applications
- **Perfect to be used with Spill Safety Stations**

Order Reference	Article No.	Description	Colour	Total Qty/ Pack	Absorption Capacity (Ltrs)
MRO365-P	834176	ROLL, 19 cm x 15 m, Heavyweight, perforated & bonded, 60 pads per roll	Grey	1 Roll(s) / Bag	15
UN295-P	834177	ROLL, Medium weight, double perforated & bonded 19 cm x 15 m, 60 pads per roll	Green	1 Roll(s) / Bag	12





## SKH-MINI

A FULLY DISPOSABLE SPILL KIT TO CLEAN UP SMALL CHEMICAL SPILLS EASILY AND WITHOUT RISK OF INJURIES.

- The autoclavable disposal bag is heat resistant up to 145°C to guarantee safe disposal of laboratory waste.
- Suited for spills of up to 1.7 litres, absorbing chemicals, water & oil based fluids.
- The specially designed disposable brush is intended to sweep up any broken glass or debris allowing a safe clean up without risk of injuries.
- Compact design: the SKH-MINI can easily be placed in any areas where it is most needed.
- Protective gloves are powder free, have roughened fingertips, increased tear resistance and a good chemical resistance for more safety.

**Contents:** 2 pads (41 cm x 51 cm), 1 pair of disposable chemical protective gloves, 1 autoclavable disposal bag, 1 disposable brush and 1 multilingual instruction guide.

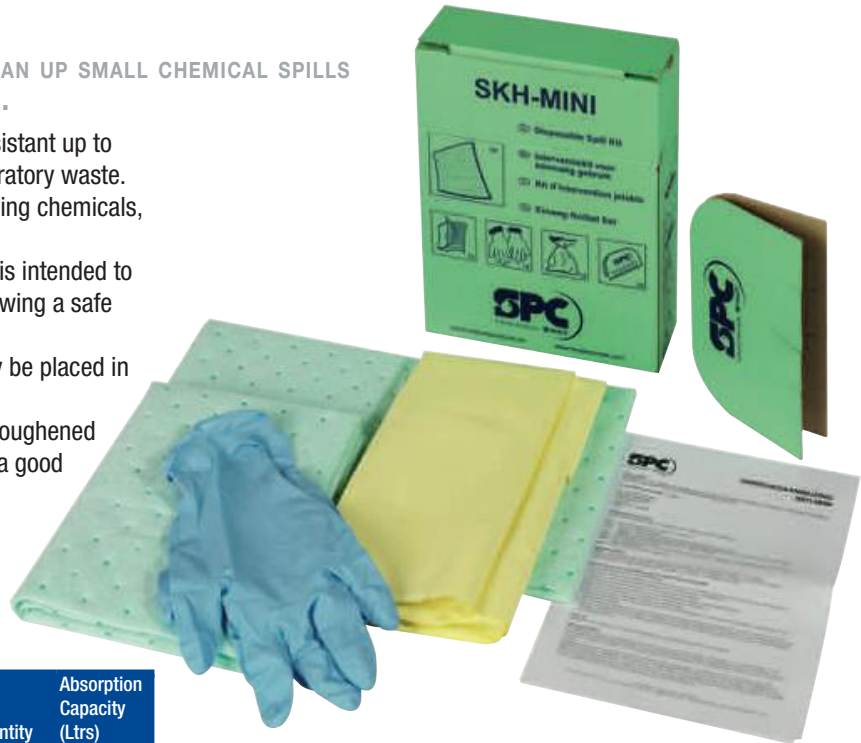

Order Reference	Article No.	Description	Quantity	Absorption Capacity (Ltrs)
SKH-MINI	813868	Disposable spill kit, chemical	4 Kits/Box	7.00

\*4 x 1.7 litres

## HAZWIK PILLOWS - FOR ABSORBING SPILLS & LEAKING LIQUIDS IN TIGHT SPACES.



Protection of fragile liquids during transport.

- Absorb chemicals, acids & bases.
- Good for large spills once contained.
- Ideal for use in packaging for extra protection during transport.
- 2 different sizes to fit any application.



Order Reference	Article No.	Description	Total Qty/Pack	Absorption Capacity (Ltrs)
HAZ1818	813853	Pillow, 43 cm x 48 cm	16 Piece(s) / Box	105
HAZ1818-2	813854	Pillow, 43 cm x 48 cm	8 Piece(s) / Box	53
HAZ99	813855	Pillow, 23 cm x 23 cm	32 Piece(s) / Box	58



## UN Booms

THE BEST WAY TO ABSORB AND CONTAIN LARGE SPILLS OF CHEMICALS AND HAZARDOUS LIQUIDS.

- Absorb chemicals, acids & bases as well as oils and water-based liquids.
- Metal clips & rings allow for easy linking of booms.
- Inner rope secured with four clips provides strength.
- Strong outer sleeve for durability.
- Inner sleeve keeps the adsorbent material intact within the boom.



Order Reference	Article No.	Description	Total Qty/Pack	Absorption Capacity (Ltrs)
UN810	813848	Boom, Ø 20 cm x 3 m	4 Piece(s) / Bag	261
UN510	813849	Boom, Ø 13 cm x 3 m	4 Piece(s) / Bag	119



## HAZWOC Socs

CONFINE & PREVENT HAZARDOUS SPILLS FROM SPREADING.

- Absorb chemicals, acids & bases.
- Different lengths available to always have the right size for your application.
- Flexible design is easily moulded around machines and spills.

Order Reference	Article No.	Description	Total Qty/Pack	Absorption Capacity (Ltrs)
HAZ412	813850	Soc, Ø 7.6 cm x 122 cm	12 Piece(s) / Box	43
HAZ806	813851	Soc, Ø 7.6 cm x 244 cm	6 Piece(s) / Box	43
HAZ124	813852	Soc, Ø 7.6 cm x 366 cm	4 Piece(s) / Box	43

## UN PADS & ROLLS

FOR USE WHEN CHEMICALS AND HAZARDOUS LIQUIDS ARE INVOLVED!

- Chemically inert: product does not degrade or cause a dangerous chemical reaction with the adsorbed liquid.
- One-sided spunbond gives extra strength as well as lower lint.
- Perforated for flexibility – tear at the perforations for smaller sized pads to use only what you need.

### Pads

Order Reference	Article No.	Description	Total Qty/Pack	Absorption Capacity (Ltrs)
UN100-E	813842	PADS, 41 cm x 51 cm, Medium weight, perforated & bonded	100 Pad(s) / Box	89
UN1212-E	813843	PAD, Medium weight, bonded 30 cm x 30 cm, 50 pads/Bag, 4 Bags/disp.box	200 Pad(s) / Dispenser Box	77

### Rolls

Order Reference	Article No.	Description	Total Qty/Pack	Absorption Capacity (Ltrs)
UN15-2DP-E	813844	ROLL, Medium weight, double perforated & bonded 38 cm x 46 m	2 Roll(s) / Box	149
UN15-DP-E	813845	ROLL, Medium weight, double perforated & bonded 38 cm x 46 m	1 Roll(s) / Dispenser box	75
UN15-DPS-E	813846	ROLL, Medium weight, double perforated & bonded 38 cm x 23 m	1 Roll(s) / Dispenser box	37
UN30-DP-E	813847	ROLL, Medium weight, double perforated & bonded 76 cm x 46 m	1 Roll(s) / Box	149
UN295-P	834177	ROLL, Medium weight, double perforated & bonded 19 cm x 15 m, 60 pads per roll	1 Roll(s) / Bag	12

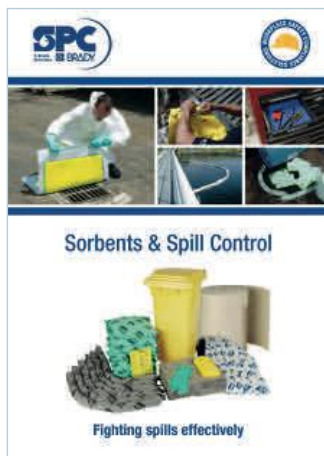

### SPC - Sorbent Products

Your partner in helping your business guard against the leaks, drips and spills that create safety and environmental hazards in the workplace with quality sorbent products.

Contact your Brady Distributor to receive a copy of the SPC catalogue



## PIPEMARKERS

- This pipemarker dimension (12 x 150 mm) has been specially developed by Brady for the identification of small pipes.
- Ideal for marking Piped Medical Gases, these markers are made from thin, flexible polyester (B-7541)
- For Pipes with a diameter from 6 to 20mm
- Sold by the card, with 5 markers per card
- Many legends available - please visit [www.bradyeurope.com](http://www.bradyeurope.com) for full listing

Label Width A (mm)	Label Height B (mm)	Letter height (mm)	Total Qty/Pack
150.00	12.00	6.5	5 Marker(s) / Card



## SAFETY SIGNS ON ROLLS

- Material: Laminated Polyester
- Number of signs per roll: 250
- Available Sizes: Triangular with sides of 25, 50 or 100 mm
- Labels are supplied die-cut to a triangular shape



Width (mm)	W016	W023	W003	W009
25 mm	828682	829718	826758	827646
50 mm	828684	829720	826760	827648
100 mm	828686	829722	826762	827650



Contact your Brady Distributor to receive a copy of Brady's Pipe Marking and Safety Signs brochures.

Surfing **[www.bradyeurope.com](http://www.bradyeurope.com)** is a simple, efficient and timesaving way to learn more about BRADY products and applications, industry developments, events, promotions, etc. anytime, anywhere.

For looking up technical data sheets, downloading upgrades to your BRADY printers and software or fast registration of your BRADY products, there's just one address:

**[www.bradyeurope.com](http://www.bradyeurope.com)**



**[www.bradyeurope.com](http://www.bradyeurope.com)**



**Africa**

Randburg, South Africa  
 Tel.: +27 11 704 3295  
 Email: africa@bradycorp.com

**Benelux**

Zele, Belgium  
 Tel.: +32 (0) 52 45 78 11  
 Email: benelux@bradycorp.com

**Central & Eastern Europe**

Bratislava, Slovakia  
 Tel.: +421 2 3300 4800  
 Email: central\_europe@bradycorp.com

**Denmark**

Odense  
 Tel.: +45 66 14 44 00  
 Email: denmark@bradycorp.com

**France**

Roncq  
 Tel.: +33 (0) 3 20 76 94 48  
 Email: france@bradycorp.com

**Germany, Austria & Switzerland**

Egelsbach, Germany  
 Tel.: +49 (0) 6103 7598 660  
 Email: germany@bradycorp.com

**Hungary**

Budaörs  
 Tel.: +36 23 500 275  
 Email: central\_europe@bradycorp.com

**Italy**

Gorgonzola  
 Tel.: +39 02 26 00 00 22  
 Email: italy@bradycorp.com

**Middle East FZE**

Dubai, UAE  
 Tel.: +971 4881 2524  
 Email: me@bradycorp.com

**Norway**

Kjeller  
 Tel.: +47 70 13 40 00  
 Email: norway@bradycorp.com

**Romania**

Bucharest  
 Tel.: +40 21 202 3032  
 Email: central\_europe@bradycorp.com

**Russia**

Moscow  
 Tel.: +7 495 269 47 87  
 Email: central\_europe@bradycorp.com

**Spain & Portugal**

Madrid, Spain  
 Tel.: +34 900 902 993  
 Email: spain@bradycorp.com,  
 portugal@bradycorp.com

**Sweden, Finland, Baltic states**

Kista, Sweden  
 Tel.: +46 (0) 8 590 057 30  
 Email: sweden@bradyeurope.com

**Turkey**

Istanbul  
 Tel.: +90 212 264 02 20 / 264 02 21  
 Email: turkey@bradycorp.com

**UK & Ireland**

Banbury, UK  
 Tel.: +44 (0) 1295 228 288  
 Email: uk@bradycorp.com

# Our mission is to identify and protect people, products and places



To help minimise our impact on the environment, Brady limits its number of reprints.

Updated versions are always available for download on [www.bradyeurope.com](http://www.bradyeurope.com).

 Search for: EUR-M-513-EN



Your distributor

26/11/2019