



RF

**INTERCONNECT
CATALOG**

COMPLETE RF INTERCONNECT SOLUTIONS

With the right mix of industry experts and knowledgeable engineers, Samtec can assist with challenges throughout a customer's system – including those specific to RF.

TECHNICAL SUPPORT

- Launch Optimizations
- Simulations
- Test & Measurements
- Customs

RF Technical Group: RFTechnicalGroup@samtec.com

Signal Integrity Group: SIG@samtec.com



PRECISION RF

- Bulls Eye® high-performance test to 50 GHz
- 34 / 40 / 50 / 65 GHz solutions
- Variety of options, including compression mount or blind-mate

UNMATCHED SERVICE

- 24-hour samples and quotes
- No minimum order quantity on standards
- 2 to 5 day lead time on standard products



TABLE OF CONTENTS

Overview

| | |
|--|-------|
| Bulls Eye® High-Performance Test Systems | 4-5 |
| Precision RF | 6 |
| Customs and Mix-and-Match Solutions | 7 |
| 50 Ω Cables and Connectors | 8-9 |
| 75 Ω Cables and Connectors | 10-11 |
| Cable Selector Chart | 12-13 |
| Original Solutions | 14 |

50 Ω and 75 Ω Cable Assemblies

| | |
|---|-------|
| Bulls Eye® High-Performance Test Systems | 16-20 |
| Micro High Frequency U.FL/W.FL Assemblies | 22-23 |
| 50 Ω Cable Assemblies | 24-36 |
| 75 Ω Cable Assemblies | 37-40 |

50 Ω and 75 Ω Connectors

| | |
|---|-------|
| 50 Ω (2.92 mm, SMA, SMP, SMB, MMCX, MCX, BNC, N Type, TNC) | 42-54 |
| 75 Ω (DIN 1.0/2.3, HD-BNC™*, BNC, SMB) | 55-60 |

Original RF Solutions

| | |
|--|-------|
| 100 Ω Shielded Twisted Pair System | 62-63 |
| Micro-Mini Ganged Systems | 64-70 |
| 50 Ω Cable Assembly with High-Cycle U.FL Plug | 71 |
| 75 Ω MMCX & MCX | 72-73 |
| IsoRate® Systems | 74-77 |
| Custom Solutions | 78 |

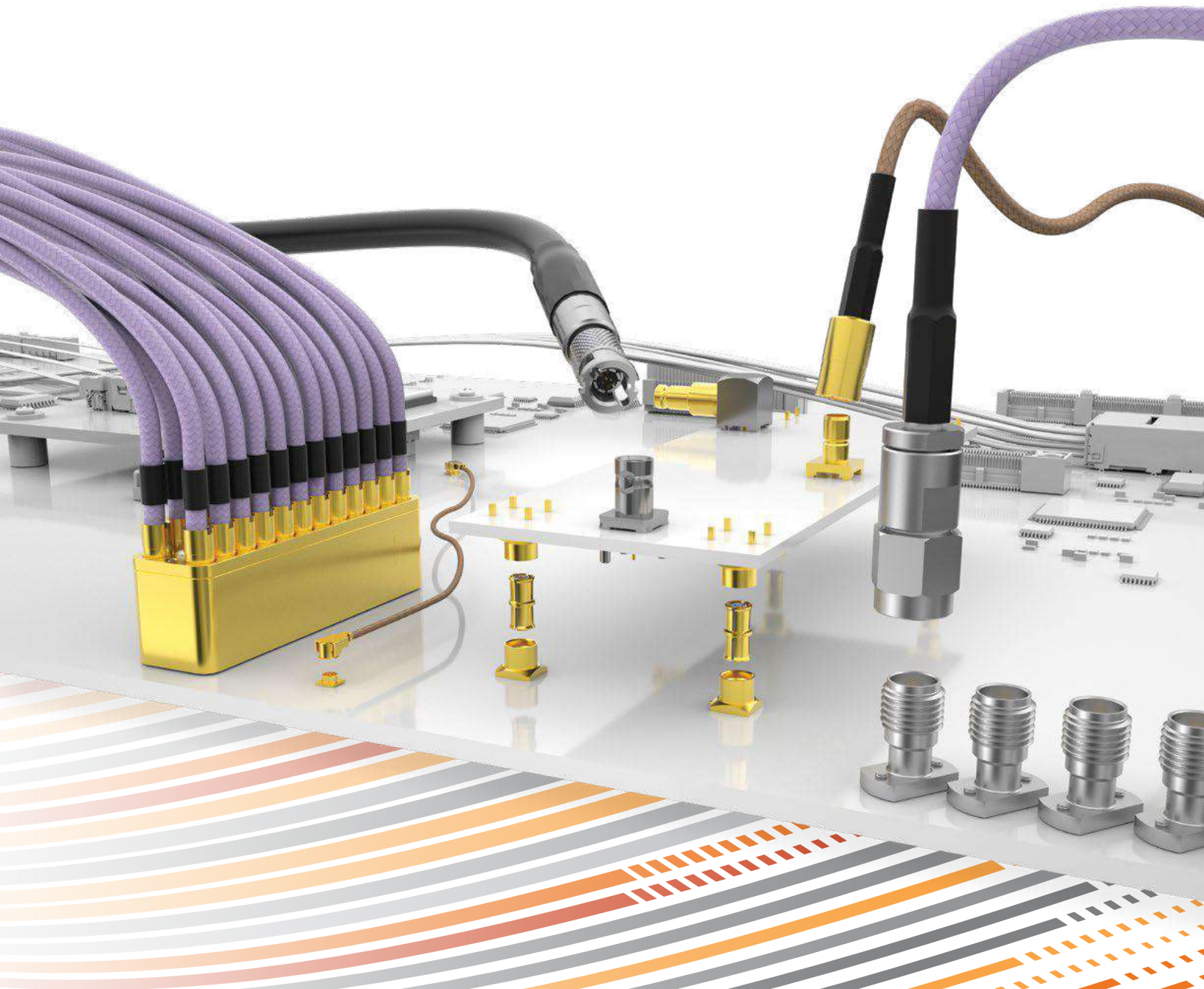

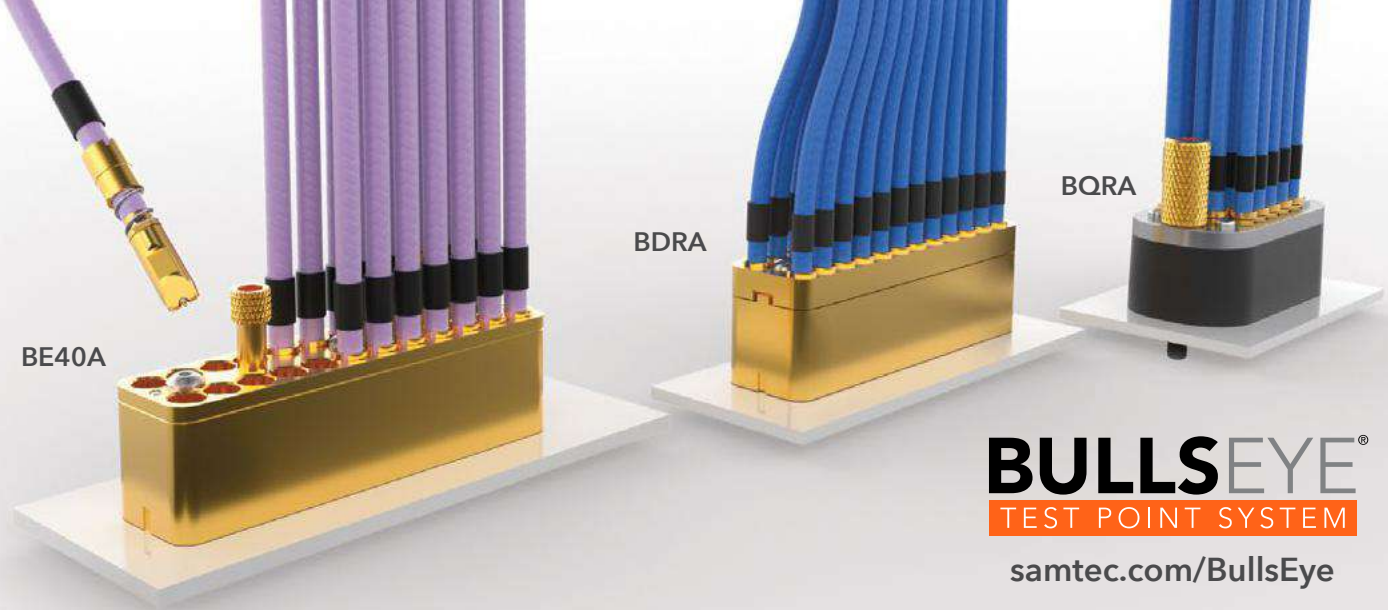

HIGH-PERFORMANCE TEST TO 50 GHz

The high-density array designs and advanced cabling solutions within Samtec's Bulls Eye[®] product family enable optimized performance to 50 GHz. A compression interface, small footprint and high cycle count make Bulls Eye[®] ideal for high-performance test applications.

Bulls Eye[®] Product Family Features:

- Compression interface to the board provides easy on/off and eliminates soldering costs
- Small footprint design significantly saves space on the board
- Microstrip or Stripline PCB transmission
- Assembly options: Dual Row (BE40A, BDRA) and Quad Row (BQRA)
- Installation: While the attach process for each series is similar, each have unique specifications that need to be observed. Contact RFTechnicalGroup@samtec.com.
- To 65 GHz in development

Transmission Types:

- Two options: Microstrip (BE40A) or Stripline (BE40A, BDRA, BQRA)
- Compression interface to the board

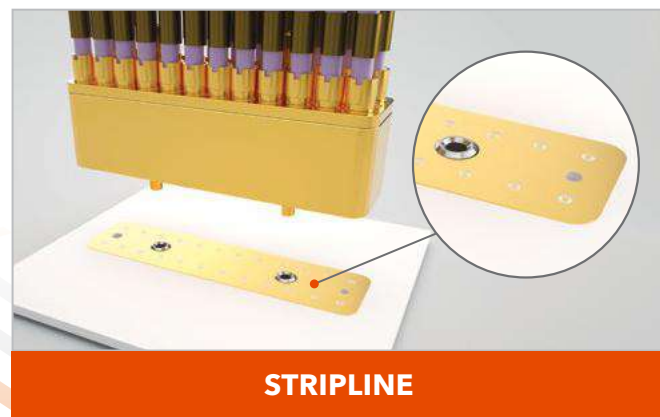
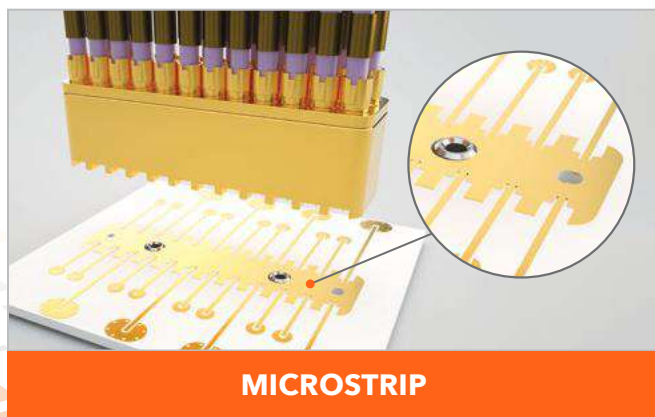

BE40A SERIES 50 GHz, Double Row

- Enhanced system design with signal and ground pogo pins
- Microstrip or Stripline PCB transmission
- Backward compatible with BDRA Series
- 50 Ω impedance
- Positions: 2x 3, 4, 6, 8, 10, 12, 14, 16
- End 2 options: 2.92 mm, 2.4 mm also available
- 23 AWG solid dielectric, low loss microwave cable with additional copper shielding
- Replacement components available:
Cables (BE40C Series) | Block (BE40B Series)

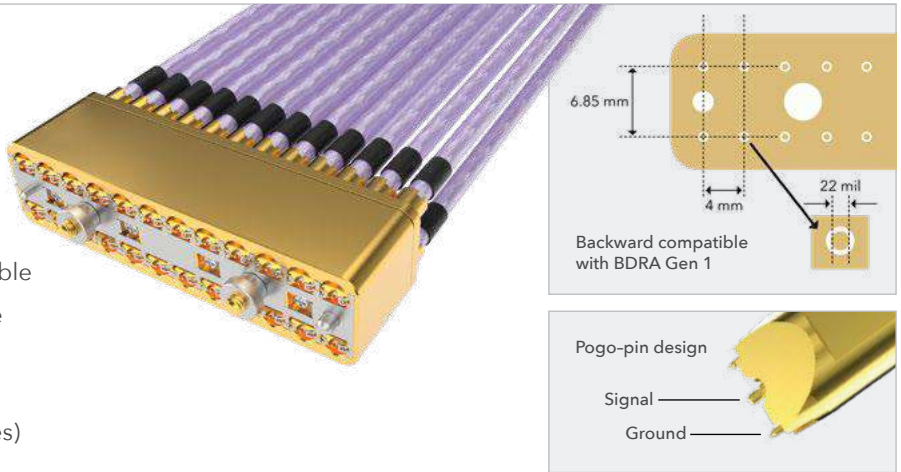

BDRA SERIES 20 GHz, Double Row

- 23 AWG solid dielectric, low loss microwave cable
- Stripline PCB transmission
- Fixed-pin design
- 50 Ω impedance
- Positions: 2 x 12
- End 2 options: 2.92 mm, SMA also available
- Replacement components available:
Cables (BE23S Series) | Block (BQR Series) | Elastomer

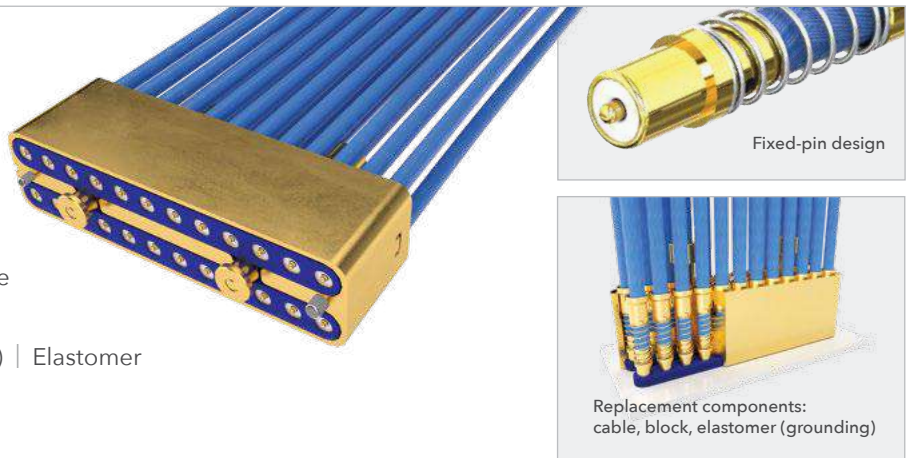

BQRA SERIES 20 GHz, Quad Row

- 23 AWG solid dielectric, low loss microwave cable
- Stripline PCB transmission
- Fixed-pin design
- 50 Ω impedance
- Positions: 20 (Quad Row)
- End 2 options: 2.92 mm, SMA also available
- Replacement components available:
Cables (BE23S Series) | Block (BDR Series) | Elastomer

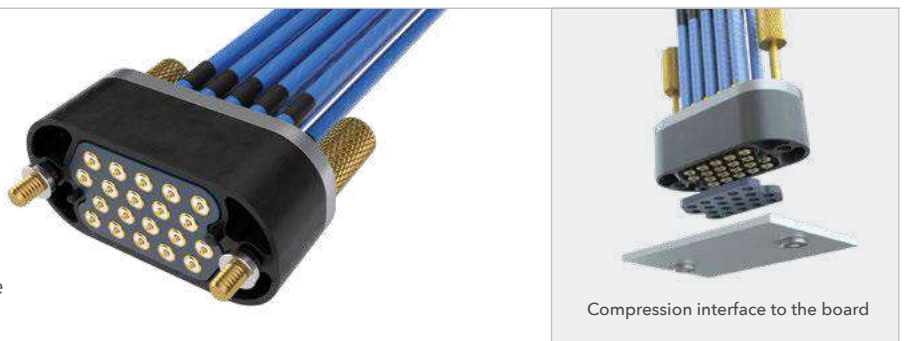

| Series | BE40A | BDRA | BQRA | Replacement Components |
|------------------|---|------------------------------|---------------|---|
| Cable | 23 AWG, additional shielding | 23 AWG, additional shielding | | For BE40A: BE40C, BE40B For BDRA: BE23S, BDR For BQRA: BE23S, BQR |
| PCB Transmission | Microstrip or Stripline | Stripline | | |
| Ground | Pogo-pin design on Bulls Eye® probe end | Elastomer | | |
| Positions | 2 x 3, 4, 6, 8, 10, 12, 14, 16 | 2 x 12 | 20 (Quad Row) | |
| Frequency (GHz) | Up to 50 | Up to 20 | | |
| Page | 17 | 18 | 19 | 20 |

65 GHz high-performance test solution in development.

PRECISION INTERCONNECTS

ROADMAP

RFTechnicalGroup@samtec.com

34
GHz

3.50 mm

- Edge mount with screw downs
- High-performance microwave cable assembly: 23 AWG (RF23S Series)

40
GHz

2.92 mm

- Compression mount with 2-hole flange in various board thicknesses
- High-performance microwave cable assembly: 23 AWG (RF23C Series)

SMP

- Straight & right-angle, full detent & smooth bore
- Blind-mate with axial alignment
- High-performance microwave cable assembly: 24 AWG (RF405 Series), 25 AWG (RF25S Series) and .047 Cable (in development)

50
GHz

2.40 mm

- Compression mount with 2-hole flange in various board thicknesses
- High-performance microwave cable assembly: 23 AWG (RF23C Series)

65
GHz

1.85 mm

- Compression mount with 2-hole flange in various board thicknesses

SMPM

- Straight & right-angle, full detent & smooth bore
- Blind-mate with axial alignment
- High-performance microwave cable assembly: .047 Cable (in development)



| | | | | |
|------------------------------|-----|-----------|-----|------------|
| Precision Interconnects (mm) | 3.5 | 2.92, SMP | 2.4 | 1.85, SMPM |
| Performance (GHz) | 34 | 40 | 50 | 65 |

Bulls Eye® High-Performance Test Array

High-density array design significantly saves space on the board compared to traditional test points.

See pages 4-5.

Wide variety of Precision interconnects for high-performance testing.

MIX-AND-MATCH END OPTIONS

on standard cable assemblies, with standard pricing and lead times

View series-specific catalog pages for all end options and details. Or, use the charts below as a quick reference guide.

| HIGH FREQUENCY MICROWAVE | | | | 50 Ω RF CABLES | | | | 75 Ω RF CABLES | | | |
|--------------------------|-----|---------------------------|--------|----------------|-----|--|------------------------------------|----------------|-----|-----------------------------------|------------------------|
| CABLE | AWG | END OPTIONS | SERIES | CABLE | AWG | END OPTIONS | SERIES | CABLE | AWG | END OPTIONS | SERIES |
| MWC-2350CU-01 | 23 | 2.92 mm, 2.4 mm, SMA, SMP | RF23C | 0.81 | 36 | MHF1, MHF3, SMA | MH081 | RG 179 | 30 | MCX, MMCX7, SMB, BNC, DIN 1.0/2.3 | RF179, GRF7-C, GRF7H-C |
| MWC-2350-01 | 23 | 3.50 mm | RF23S | 1.13 | 32 | MHF1, SMA | MH113 | 1855A | 23 | BNC, HD-BNC™, DIN 1.0/2.3 | RFB8T |
| MWC-2550-01 | 25 | SMA, SMP | RF25S | RG 178 | 30 | MMCX, MCX, SMA, SMB, BNC, TNC, N Type | RF178 | 1694A | 18 | | RFB6T |
| CCA-047 | 28 | HMHF1, SMA | RF047 | RG 174 | 26 | MMCX, MMCXV, MCX, SMA, SMB, BNC, TNC, N Type | RF174 | RG 6 | 18 | | RFA6T |
| RG 405 | 24 | SMA, SMP | RF405 | RG 316 | 26 | MMCX, MMCXV, MCX, SMA, SMB, BNC, TNC, N Type | RF316, IJ5C, IJ5H, GRF1-C, GRF1H-C | | | | |
| RG 402 | 19 | SMA | RF402 | RG 58 | 20 | SMA, TNC, N Type | RF058 | | | | |

rf.samtec.com | Solutionator® Online RF Assembly Builder

Solutionator is Samtec's online parametric filter that lets you easily choose your product and board-level mate in a matter of minutes. It also connects you directly to:



LIVE CHAT with an RF engineer



VIEW engineering drawings



REQUEST samples and quotes

CUSTOM SOLUTIONS

28% of Samtec's total sales are in customs or product modifications. This includes RF. Why is this? Samtec has the willingness, expertise and service to make it happen.

23% Express Modifications
92% do not require engineering or tooling charges

5% Engineered Customs

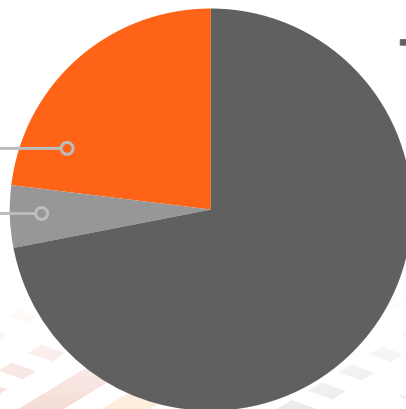

TOTAL SALES

See additional details on **page 78** regarding RF Express or Engineered customs.

50 Ω RF CABLES & CONNECTORS



WIDE VARIETY OF CABLES

- High frequency microwave cables:
 - Hand-formable semi-flexible cables at .047" DIA, .086" DIA or .141" DIA
 - 23 AWG or 25 AWG solid dielectric cables to 50 GHz
 - 10 GHz, 500 cycle U.FL HMHF1 plug terminations
- Micro High Frequency U.FL/W.FL cable assemblies
- Industry standard cables with mix-and-match end options:
 - RG 316, RG 174, RG 178, RG 58
- Double-shielded RG 316 cable for approx. 75 dB shielding effectiveness

PRECISION INTERCONNECTS

See page 6



50 Ω HIGH FREQUENCY CABLE ASSEMBLIES

| Series | RF405 | RF402 | RF23C | RF23S | RF25S |
|--------------|------------------------------|-----------|-----------------------------|---------|----------|
| Type | 0.86" DIA | .141" DIA | 23 AWG | | 25 AWG |
| Type Cable | Hand-formable, semi-flexible | | Solid dielectric, microwave | | |
| Terminations | SMA, SMP | SMA | 2.92 mm, 2.40 mm | 3.50 mm | SMA, SMP |
| Page | 32 | 33 | 34 | 36 | 36 |

50 Ω STANDARD CABLE ASSEMBLIES

| MH081/MH113 | RF174/RF316 | RF178 | RS316 | RF058 |
|-----------------|--|---------------------------------------|------------------------|------------------|
| U.FL & W.FL | Commodity components & assemblies | | | |
| 0.81 mm/1.13 mm | RG 174/RG 316 | RG 178 | RG 316 double-shielded | RG 58 |
| MHF1, MHF3, SMA | SMA, SMB, MCX, MMCX, MMCXV, BNC, TNC, N Type | SMA, SMB, MCX, MMCX, BNC, TNC, N Type | SMA | SMA, TNC, N Type |
| 22-23 | 24-25, 28-29 | 26-27 | 30 | 31 |



WIDE VARIETY OF TERMINATIONS

- MHF (U.FL/W.FL), HMHF1 (High Cycle U.FL)
- 2.92 mm, 2.40 mm, 3.50 mm, SMA, SMP, SMB, MCX, MMCX, BNC, TNC, N Type and high vibration MMCX (MMCXV)
- Straight and right-angle available for most; variety of jacks and plugs
- Bulkhead jack options

BOARD LEVEL INTERCONNECTS

- Straight or right-angle orientations
- Through-hole, surface mount, edge mount or mixed technology
- 2.92 mm, SMA, SMB, SMP, MCX, MMCX, BNC and TNC
- MMCX jacks/plugs and switchable internal/external antenna jack

- SMP Plugs & Adaptors
 - Compensates for misalignment in X & Y directions
 - Bullet adaptor allows for flexible connections
 - Frequency range: DC to 40 GHz

50 Ω BOARD LEVEL INTERCONNECTS

| Series | 292 | SMA | SMP | SMB5 | MMCX* | MCX | BNC5 |
|--------------|-------------|-------------------------|---------------------|-------------|-------------------------|-------------------------|------|
| Type | 2.92 mm | SMA | Floating System | SMB | MMCX | MCX | BNC |
| Orientation | Straight | Straight, Right-Angle | | Right-Angle | Straight, Right-Angle | | |
| Terminations | Panel Mount | T/H, SM, MT, Edge Mount | T/H, MT, Edge Mount | T/H | T/H, SM, MT, Edge Mount | T/H, SM, MT, Edge Mount | T/H |
| Page | 42-43 | 44-46 | 47 | 48 | 49, 51 | 50-51 | 52 |

* High vibration available. Contact Samtec.

75 Ω RF CABLES & CONNECTORS



WIDE VARIETY OF CABLES

- Industry standard cables with mix-and-match end options: RG 179, RG 6, Belden 1694A, Belden 1855A
- RFB8T Series (with Belden 1855A cable)
- Components are available for customer-installed field termination to cable

WIDE VARIETY OF TERMINATIONS

- BNC, HD-BNC™, DIN 1.0/2.3
- 75 Ω SMB to 8 GHz
- Straight and right-angle orientations
- Die cast options available
- Unique-to-Samtec Mini and Micro-mini components with higher extraction force
- See page 14 for board mates (MCX7, MMCX7)

BOARD LEVEL INTERCONNECTS

- 12G-SDI Broadcast Video Solutions: BNC, HD-BNC™, DIN 1.0/2.3
- Through-hole, surface mount, edge mount and straight or right-angle orientations
- SMB, DIN 1.0/2.3, HD-BNC™, BNC jacks
- BNC includes low-profile, right-angle
- HD-BNC™ for high-density applications
- 75 Ω SMB jacks

75 Ω STANDARD CABLE ASSEMBLIES

| Series | RFA6T | RFB6T | RF179 | RFB8T |
|--------------|-----------------------------------|---------------------------|-----------------------------------|----------------------|
| Type | Commodity components & assemblies | | | |
| Type Cable | RG 6 | 1694A | RG 179 | 1855A |
| Terminations | HD-BNC™, BNC, DIN 1.0/2.3 | HD-BNC™, BNC, DIN 1.0/2.3 | MMCX7, MCX, SMB, BNC, DIN 1.0/2.3 | HD-BNC™, DIN 1.0/2.3 |
| Page | 37 | 37 | 38-39 | 40 |

* HD-BNC™ is a trademark of Amphenol.



HD-BNC



HD-BNC™

BNC

HIGH-DENSITY BNC SYSTEMS

- 4X the panel density of traditional BNCs
- Patented design and bayonet latch
- 20% reduction in weight of traditional BNCs
- Crimp style plugs use industry standard termination tools
- Compatible with Amphenol's HD-BNC™

BROADCAST VIDEO SOLUTIONS



samtec.com/12GSDI

Samtec has the largest variety of 12G-SDI products available: BNC, HD-BNC™ and DIN 1.0/2.3 with a variety of orientation and termination options including low-profile, right-angle.

Contact RFTechnicalGroup@samtec.com for more information.

75 Ω BOARD LEVEL INTERCONNECTS

| Series | DIN7A | HDBNC | BNC7T | SMB7H |
|--------------|-----------------------|-----------------------|-----------------------|-----------------------|
| Type | DIN 1.0/2.3 | High-Density BNC | BNC | SMB |
| Orientation | Straight, Right-Angle | Straight, Right-Angle | Straight, Right-Angle | Straight, Right-Angle |
| Terminations | T/H | T/H, Edge Mount | T/H, Edge Mount | T/H, Edge Mount |
| Page | 55 | 56-57 | 58-59 | 60 |
| 12G-SDI | ✓ | ✓ | ✓ | |

RF CABLE SPECIFICATIONS



| CABLE TYPE | | 50 Ω CABLES | | | | | | | |
|--------------------------|----------------------|----------------------|---------------|---------------------------------------|----------------------|--|------------------------------------|---------------------------------|--------------------|
| | | 0.81 | 1.13 | RG 178 | CTB-2650F-01 | RG 174 | RG 316 | RG 316 DS | RG 58 |
| Impedance | Ω | 50 ± 3 | 50 ± 2 | | 50 ± 5 | 50 ± 2 | 50 ± 3 | | |
| Attenuation (dB/m) | 100 MHz | 1.0 | 0.6 | 0.5 | 0.68 | 0.4 | 0.3 | 1.4 @ 2 GHz | 0.2 |
| | 1 GHz | 3.1 | 1.9 | 1.7 | 2.37 | 1.4 | 1.25 | 1.6 @ 3 GHz | 0.8 |
| | 6 GHz | 8.6 | 4.9 | 5.9 | 6.53 | 4.4 | 4.25 | 2.2 @ 5 GHz | 5.4 |
| Dielectric Constant (dk) | ----- | 2.0 | | 2.1 | 1.56 | 2.3 | 2.1 | | 2.3 |
| Dielectric Strength | VAC | 1000 | 500 | 1000 | ----- | 500 | 1200 | ----- | 1400 |
| Propagation Delay | nS/m | 4.70 | | 4.83 | 4.17 | 5.06 | 4.83 | ----- | 5.05 |
| Current Rating | Amps | 1.2 | 2.1 | 3 | 3 | 5 | 5 | ----- | ----- |
| Capacitance | pF/m | 100 | 95 | 96 | 85.6 | 101 | 96 | 95.8 | 102 |
| Center Conductor | Material | Silver Plated Copper | | Silver Plated Copper Clad Steel | Silver Plated Copper | Bare Copper | Silver and Copper Plated Steel | Silver Plated Copper Clad Steel | Tinned Copper |
| | AWG | 36 | 32 | 30 | 26 | 26 | 26 | 26 | 20 |
| | Stranding (No./mm) | 7/0.05 | 7/0.076 | 7/0.10 | 19/0.10 | 7/0.16 | 7/0.17 | 7 | 19/0.018 |
| | Diameter (mm) | 0.15 | 0.23 | 0.31 | 0.48 | 0.48 | 0.51 | 0.53 | 0.80 |
| | Max Resistance (Ω/m) | 1.40 | 0.60 | 0.34 | 0.12 | 0.14 | 0.13 | ----- | ----- |
| Dielectric | Material | FEP | | PTFE | Foamed FEP | KLPE | PTFE | FEP | Solid Polyethylene |
| | Diameter (mm) | 0.40 | 0.68 | 0.84 | 1.29 | 1.52 | 1.52 | 1.53 | 3.00 |
| Shield | Material | Silver Plated Copper | Tinned Copper | Silver Plated Copper | | Tinned Copper | Silver Plated Copper | | Tinned Copper |
| | Diameter (mm) | 0.65 | 0.89 | 1.37 | 1.5 | 2.57 | 1.73 | 2.38 | 3.81 |
| Jacket | Material | PFA | FEP | | | PVC | FEP | | PVC |
| | Diameter (mm) | 0.81 | 1.13 | 1.80 | | 2.79 | 2.53 | 2.90 | 5.00 |
| | Temp Rating | -40 °C to +90 °C | | -50 °C to +165 °C | -40 °C to +200 °C | -20 °C to +80 °C | -55 °C to +165 °C | ----- | -50 °C to +90 °C |
| | Color | Gray | | Brown | Blue | Black | Brown | | Black |
| Bend Radius | Min | 5 mm | 6.8 mm | 10.2 mm | 3.175 mm | 25.4 mm | 12.7 mm | 12.8 mm | 48.3 mm |
| Termination Options | | MHF1, MHF3, SMA | MHF1, SMA | MMCX, MCX, SMA, SMB, BNC, TNC, N Type | IsoRate® | MMCX, MMCXV, MCX, SMA, SMB, BNC, TNC, N Type, Ganged | MMCX, MCX, SMA, BNC, TNC | SMA, TNC, N Type | |
| Samtec Series | | MH081 | MH113 | RF178 | IJ5C | RF174 | RF316, IJ5C, IJ5H, GRF1-C, GRF1H-C | RS316 | RF058 |



| 50 Ω MICROWAVE CABLES | | | | | | 75 Ω MICROWAVE CABLES | | | | 100 Ω CABLES |
|---|-------------------|---|---|---------------------------------|---------------------------------|---|---|---------------------------------|---|----------------------|
| MWC-2550-01 | MWC-2350-01 | MWC-2350CU-01 | CCA-047 (.047") | RG 405 (.086") | RG 402 (.141") | RG 179 | BELDEN 1855A | BELDEN 1694A | RG 6 | TPS-28100-RF |
| 50 ± 1 | | | 50 ± 2 | | | 75 ± 3 | | | | 100 ± 5 |
| 0.65 @ 1 GHz | 0.17 | | 0.80 @ 0.5 GHz | 0.72 @ 1 GHz | 0.40 @ 1 GHz | 0.3 | 0.12 | 0.07 | | ----- |
| 1.37 @ 4 GHz | 0.7 | | 1.15 | 2.59 @ 4 GHz | 1.04 @ 4 GHz | 0.8 | 0.37 | 0.21 | | ----- |
| 3.36 @ 20 GHz | 1.7 | | 2.62 @ 4 GHz | 4.26 @ 20 GHz | 2.30 @ 20 GHz | 3.6 | 0.97 | 0.59 | | ----- |
| 2.1 | 2.15 | | 2.1 | 2.04 | 1.99 | 1.8 | 1.42 | 1.44 | | 2.1 |
| ----- | 300 | | ----- | 1000 | | 1200 | 300 | | 2000 | ----- |
| 4.76 | 4.72 | 4.76 | ----- | 4.79 | | 4.83 | 4.12 | 4.06 | 4.03 | ----- |
| 5.3 | 7.4 | | ----- | ----- | ----- | 3 | 5 | ----- | ----- | ----- |
| 96.8 | 95.45 | 97.80 | 95.14 | 104.97 | 98.072 | 64 | 55.7 | 53.14 | | 38 |
| Silver Plated Copper | | | | Silver Plated Copper Clad Steel | Silver Plated Copper Clad Steel | Silver Plated Copper | Bare Copper | | | Silver Plated Copper |
| 25 | 23 | | 28 | 24 | 19 | 30 | 23 | 18 | | 28 |
| 1/0.45 | 1/0.57 | | 1/0.29 | 1/0.51 | 1/0.92 | 7/0.10 | 1/0.58 | 1/1.02 | | 2/0.85 |
| 0.45 | 0.57 | | 0.29 | 0.51 | 0.92 | 0.30 | 0.58 | 1.02 | | 1.97 |
| 0.105 | 0.071 | | ----- | 0.67 | 0.02 | 0.34 | 0.066 | 0.021 | | 0.029 |
| Solid FEP | | | FEP | PTFE | PTFE | PTFE | FHDPE | FHDPE | | FEP |
| 1.46 | 1.85 | | 0.92 | 1.68 | 2.98 | 1.58 | 2.59 | 4.57 | | 1.97 |
| 1. Flat Silver Plated Copper 2. Silver Plated Copper Braid | | 1. Flat Silver Plated Copper 2. Copper Tape 3. Silver Plated Copper Braid | 1. Flat Silver Plated Copper 2. Silver Plated Copper Braid | Tinned Copper | | Silver Plated Copper | 1. Al Foil-Polyester Tape-Al Foil 2. Tinned Copper | 1. Bonded Al Foil 2. Al Wire | 1. Al Foil-Polyester Tape-Al Foil 2. Tinned Copper | Silver Plated Copper |
| 1.87 | 2.25 | | 1.12 | 2.20 | 3.58 | 2.13 | 3.00 | ----- | ----- | 2.41 |
| FEP | | | ----- | ----- | ----- | FEP | PVC | PVC | | PVC |
| 2.06 | 2.59 | | 1.42 | ----- | ----- | 2.54 | 4.04 | 6.96 | 7.00 | 3.66 |
| -40 °C to +200 °C | | | -65 °C to +165 °C | -40 °C to +125 °C | | -50 °C to +165 °C | -30 °C to +75 °C | -30 °C to +75 °C | | -20 °C to +105 °C |
| Blue | | Violet | Brown | ----- | ----- | Brown | Black | | | Blue |
| 9 mm | 12 mm | 6 mm | 10 mm | 3.18 mm | 6.35 mm | 10.2 mm | 38.1 mm | 69.85 mm | | 19.05 mm |
| SMA, SMP | 3.50, 2.92 | 2.92, 2.40, SMA, SMP | HMHF1 (U.FL), SMA | SMA, SMP | SMA | MCX, MMCX7, SMB, BNC, DIN 1.0/2.3, Ganged | HD-BNC™, DIN 1.0/2.3 | BNC, HD-BNC™, DIN 1.0/2.3 | | CJT |
| RF25S | BDRA, BQRA, RF23S | RF23C, BE40A | RF047 | RF405 | RF402 | RF179, GRF7-C, GRF7H-C | RFB8T | RFB6T | RFA6T | C28S |

ORIGINAL RF SOLUTIONS

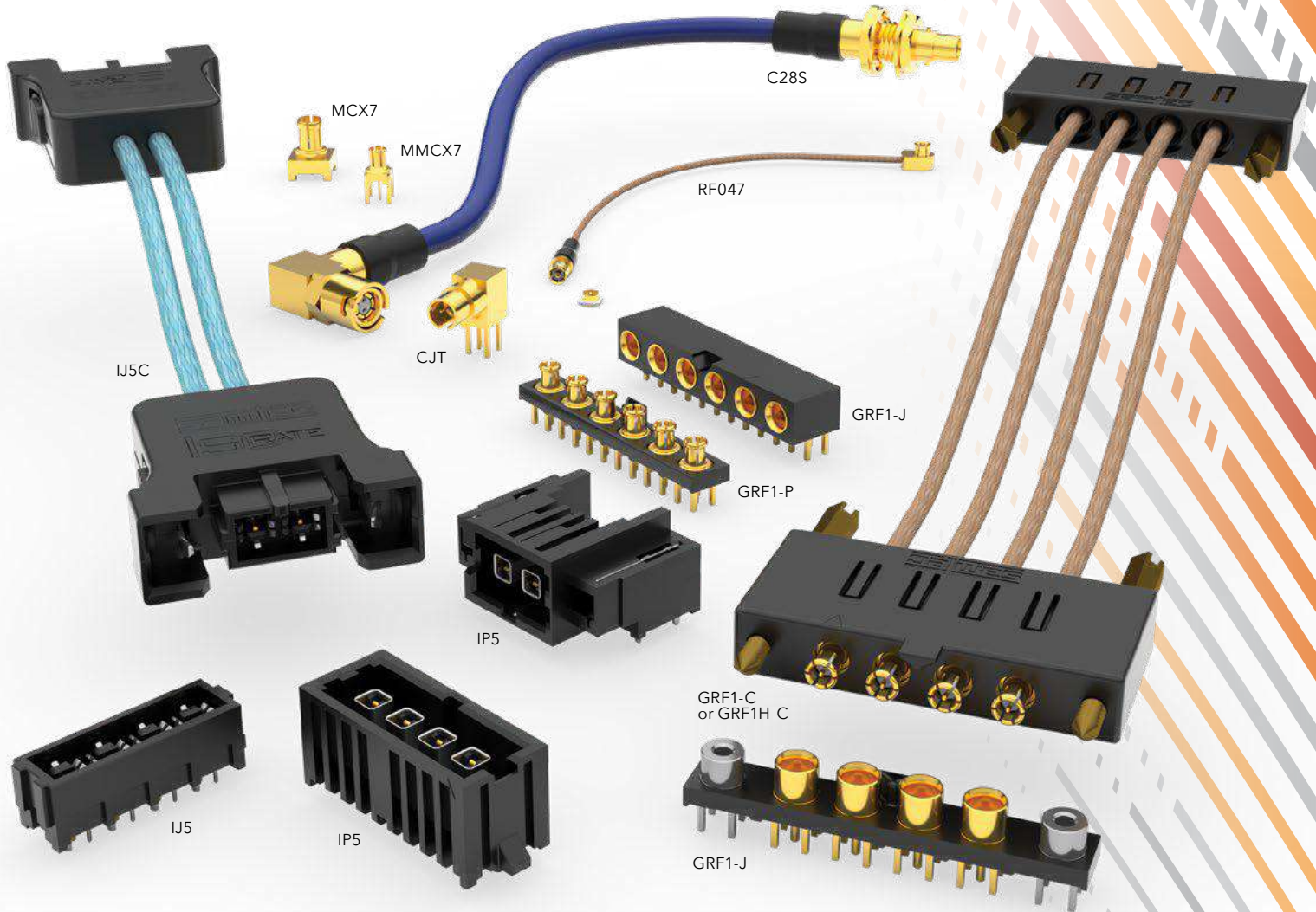

SHIELDED TWISTED PAIR SYSTEM

- 100 Ω differential pair
- 28 AWG shielded twisted pair cable assembly
- High reliability BeCu contacts
- 1/4-turn bayonet lock

GANGED MICRO-MINI SYSTEMS

- 50 Ω & 75 Ω board stacking and cable assemblies
- High performance rugged contacts
- Variety of End 2 options (GRF1H, GRF7H Series)

ISORATE® SYSTEMS

- 50 Ω board stacking and cable assemblies
- Isolated signal systems for 90 percent performance of traditional RF at 50 percent of the cost

MINI & MICRO-MINI INTERCONNECTS

- Higher extraction forces
- Not intermateable with standard MMCX, MCX

HIGH-CYCLE U.FL CABLE PLUG

- 500 cycle U.FL compatible plug (HMHF1)
- .047" DIA flexible cable (RF047 Series)

CABLE SOLUTIONS

| Series | C28S/CJT | GRF1-C | GRF1H-C / GRF7H-C | RF047 | IJ5C/IJ5H |
|-------------|-----------------------|------------------------|------------------------------------|------------------------------|---------------|
| Application | Shielded Twisted Pair | 50 Ω Micro-Mini Ganged | 50 & 75 Ω Micro-Mini Hybrid Ganged | 50 Ω .047 DIA flexible cable | 50 Ω IsoRate® |
| Page | 62-63 | 65 | 66-69 | 71 | 74-75 |

BOARD-TO-BOARD SOLUTIONS

| Series | GRF1-P/GRF1-J | GRF7-P/GRF7-J | MMCX7 | MCX7 | IJ5/IP5 |
|-------------|------------------------|------------------------|--|------|---------------|
| Application | 50 Ω Micro-Mini Ganged | 75 Ω Micro-Mini Ganged | 75 Ω Mini and Micro-Mini Interconnects | | 50 Ω IsoRate® |
| Page | 64 | 70 | 72 | 73 | 76-77 |

BULLS EYE®

HIGH PERFORMANCE TEST SYSTEMS

| | |
|---|----|
| Bulls Eye® Cross Reference Chart | 16 |
| 50 GHz, Double Row, 23 AWG Cable Assembly (BE40A) | 17 |
| 20 GHz, Double Row, 23 AWG Cable Assembly (BDRA) | 18 |
| 20 GHz, Quad Row, 23 AWG Cable Assembly (BQRA) | 19 |

REPLACEMENT COMPONENTS

| | |
|--|----|
| Replacement Block for BE40A Series Bulls Eye® Assembly (BE40B) | 20 |
| Replacement Cable for BE40A Series Bulls Eye® Assembly (BE40C) | 20 |
| Replacement Block for BDRA Series Bulls Eye® Assembly (BDR) | 20 |
| Replacement Block for BQRA Series Bulls Eye® Assembly (BQR) | 20 |
| Replacement Cable for BDRA & BQRA Series Bulls Eye® Assembly (BE23S) | 20 |

APPLICATIONS

| | |
|--|-----|
| Bulls Eye® High-Performance Test to 50 GHz | 4-5 |
|--|-----|

HIGH-PERFORMANCE TEST TO 50 GHz

BULLSEYE®
TEST POINT SYSTEM

samtec.com/BullsEye

Compression interface design, small footprint and high-cycle count make Bulls Eye® ideal for high-performance test applications.

BULLS EYE® SERIES CROSS REFERENCE

| | BE40A | BDRA | BQRA |
|------------------|--|---------------------|------------------|
| Performance | 50 GHz | 20 GHz | |
| End 2 Options | 2.40 mm Jack / Plug (50 GHz), 2.92 mm Jack/Plug | 2.92 mm Jack / Plug | |
| Cable Type | 23 AWG, Double Row, Copper Foil Shield | 23 AWG, Double Row | 23 AWG, Quad Row |
| Cable Management | Yes | | |
| PCB Transmission | Microstrip or Stripline | Stripline | |
| Ground | Pogo-pin design on Bulls Eye® probe end | Elastomer | |
| No. of Positions | 2x 3, 4, 6, 8, 10, 12, 14, 16 | 2x 12 | 20 (Quad Row) |
| Impedance | 50 Ω | | |
| Future Proof | BE40A is backward compatible with BDRA | | N/A |

Test assemblies up to 65 GHz are in development.

Replacement components are available (cables, blocks, elastomer) – See page 20.

INSTALLATION

Samtec offers a variety of series within the Bulls Eye® product family for meeting customer's criteria.

While the attach process is similar, each have unique specifications that need to be observed.

For questions, please contact RFTechnicalGroup@samtec.com.



Due to technical progress, all designs, specifications and components are subject to change without notice.

WWW.SAMTEC.COM

All parts within this catalog are built to Samtec's specifications.

Customer specific requirements must be approved by Samtec and identified in a Samtec customer-specific drawing to apply.

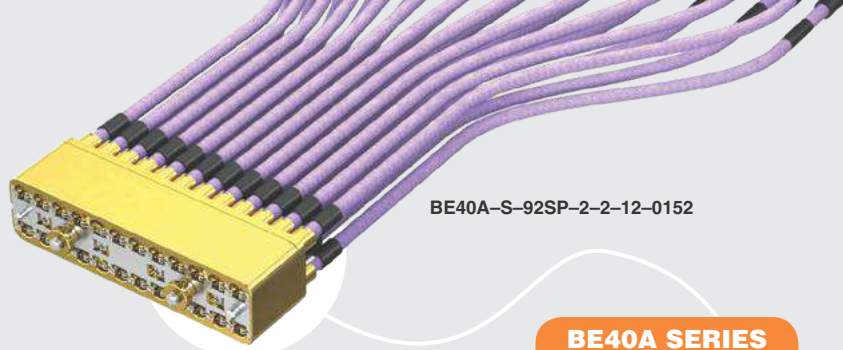

BE40A SERIES

50 GHz DOUBLE ROW TEST ASSEMBLY

SPECIFICATIONS

For complete specifications see www.samtec.com?BE40A

End 2 Connector:

Shell Material: Stainless Steel
Contact Material: BeCu

Cable Body: Stainless Steel
Insulator Material: Ultem 1000

Operating Temperature: -65 °C to +165 °C

Impedance: 50 Ω

Frequency Range: 50 GHz

RoHS Compliant: Yes

MWC-2350CU-01

Cable:

Type: Low Loss Microwave Coax

Gauge: 23 AWG

Shield Material:
1. Flat silver plated copper
2. Copper tape
3. Silver plated copper braid

Dielectric: Solid FEP

Jacket Material: FEP

Bend Radius: 6 mm

Impedance: 50 Ω ±1 Ω

Propagation Delay: 4.76 nsec/meter

Capacitance: 97.80 pF/meter

TEST REPORTS

Visit www.samtec.com?BE40A or contact RFTechnicalGroup@samtec.com for Insertion Loss, Return Loss, V.S.W.R. and other testing information.

COMPONENTS

- For replacement cable see www.samtec.com?BE40C
- For replacement block see www.samtec.com?BE40B

Backward compatible with BDRA Gen 1

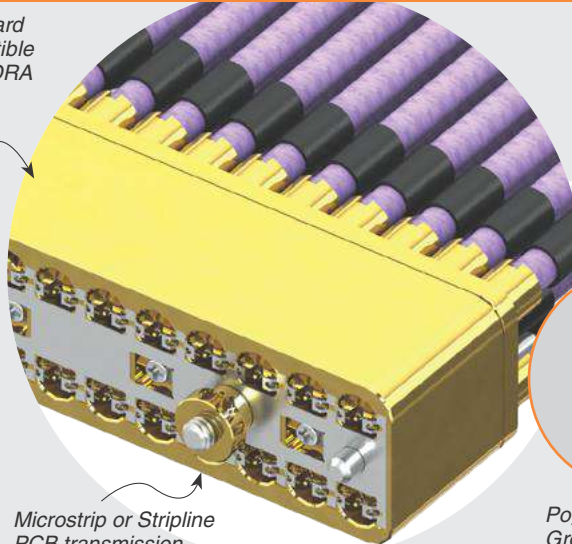

Microstrip or Stripline PCB transmission

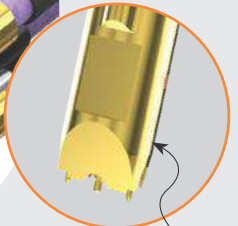

Pogo-pin design with Ground/Signal/Ground

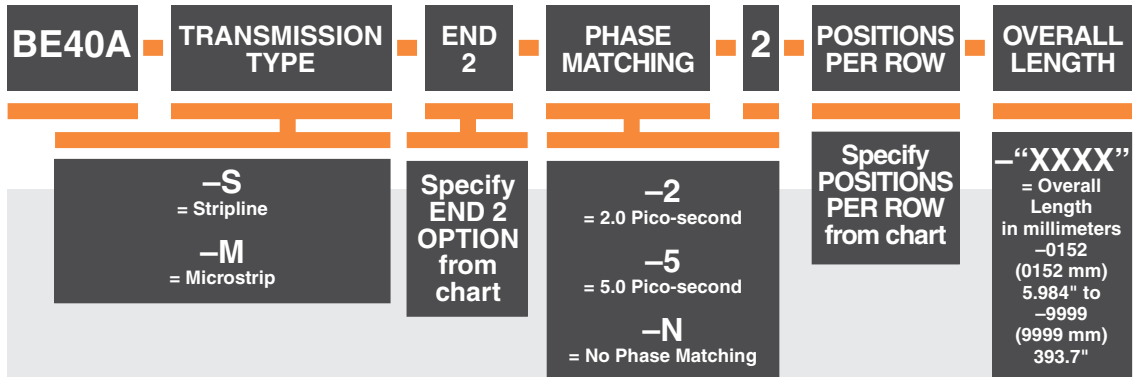

| POSITIONS PER ROW | A | B |
|-------------------|---------------|---------------|
| -03 | (13.80) .543 | N/A |
| -04 | (17.80) .701 | (14.80) .583 |
| -06 | (25.80) 1.016 | (22.80) .898 |
| -08 | (33.80) 1.331 | (30.80) 1.213 |
| -10 | (41.80) 1.646 | (38.80) 1.528 |
| -12 | (49.80) 1.961 | (46.80) 1.709 |
| -14 | (57.80) 2.276 | (54.80) 2.157 |
| -16 | (65.80) 2.591 | (62.80) 2.472 |

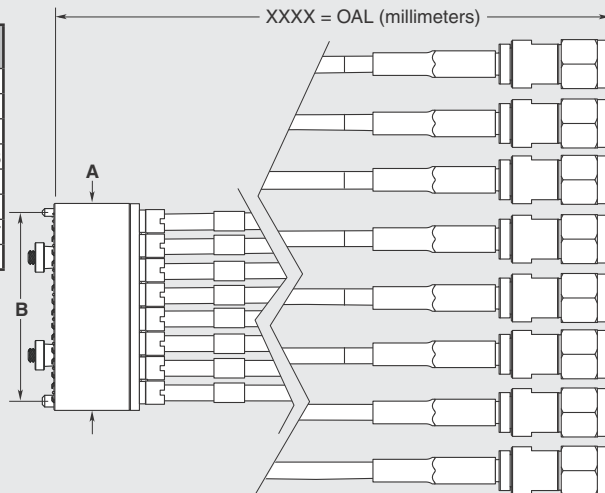

BE40A-S-92SP-XX-2-08-XXXX SHOWN

-24SJ & -24SP PRELIMINARY

| END 2 OPTIONS* | |
|--|--|
| -92SJ = 2.92 mm -24SJ* = 2.40 mm Straight Jack | |
| (30 μm (0.76 μm) Gold on Center Contact, Stainless Steel on Shell) | |
| -92SP = 2.92 mm -24SP* = 2.40 mm Straight Plug | |
| (30 μm (0.76 μm) Gold on Center Contact, Stainless Steel on Shell) | |

* 2.40 mm end option is needed for 50 GHz performance. Contact RFTechnicalGroup@samtec.com

Notes:
Cable lengths longer than 40.00" (1 meter) are not supported with S.I. test data

Some lengths, styles and options are non-standard, non-returnable.

Due to technical progress, all designs, specifications and components are subject to change without notice.

WWW.SAMTEC.COM

All parts within this catalog are built to Samtec's specifications. Customer specific requirements must be approved by Samtec and identified in a Samtec customer-specific drawing to apply.

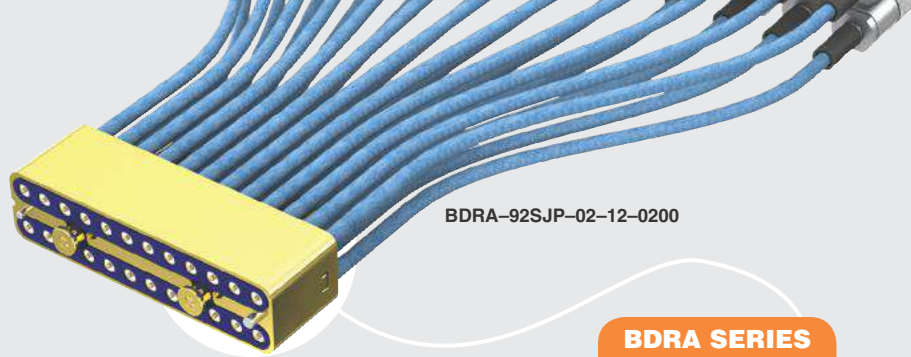

BDRA-92SJP-02-12-0200

BDRA SERIES

20 GHz DOUBLE ROW TEST ASSEMBLY

SPECIFICATIONS

For complete specifications see www.samtec.com?BDRA

End 2 Connector:

Shell Material:
Stainless Steel
Contact Material:
BeCu

Cable Body:
Stainless Steel
Insulator Material:
Ultem 1000

Operating Temperature:
-65 °C to +165 °C

Impedance:
50 Ω

Frequency Range:
20 GHz

RoHS Compliant:
Yes

MWC-2350-01

Cable:

Cable Type:
Low Loss Microwave Coax

Gauge:
23 AWG

Shield Material:
1. Flat silver plated copper
2. Silver plated copper braid

Dielectric:
Solid FEP

Jacket Material:
FEP

Bend Radius:
12 mm

Impedance:
50 Ω ± 1 Ω

COMPONENTS

- For replacement cable see www.samtec.com?BE23S
- For replacement block see www.samtec.com?BDR
- Replacement elastomer gaskets available
Contact Samtec.

Up to 24 positions
with 12 phase
matched pairs

23 AWG
cable

Stripline PCB
transmission

BDRA

END 2
CONNECTORPHASE
MATCHING

12

OVERALL
LENGTH

Specify END 2 OPTION from chart

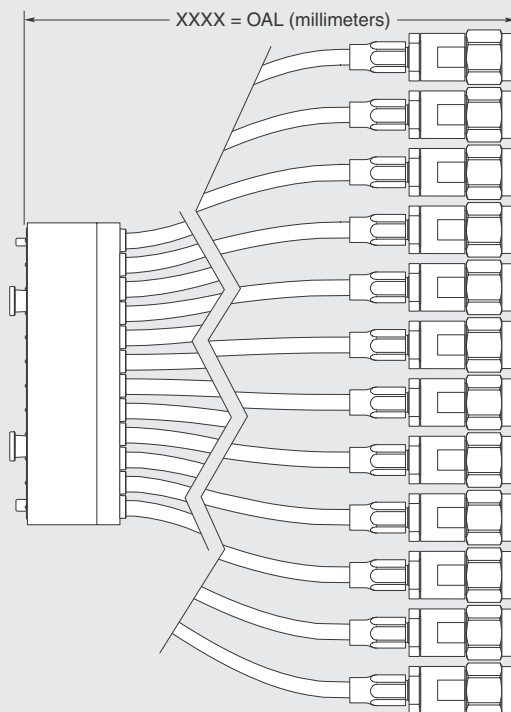

-02
= 2.0 Pico-second

-05
= 5.0 Pico-second

-10
= 10.0 Pico-second

-“XXXX”
= Overall Length
in millimeters
-0100
(100 mm) 3.94”
to -9999
(9999 mm) 393.7”

END 2 OPTIONS

92SJP = 2.92
Straight Jack
(30 μ" (0.76 μm) Gold on Center Contact,
Stainless Steel on Shell)

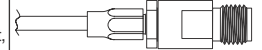

-92SPP = 2.92
Straight Plug
(30 μ" (0.76 μm) Gold on Center Contact,
Stainless Steel on Shell)

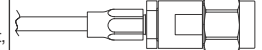

Patent:
7544093

Note:
Some lengths, styles and
options are non-standard,
non-returnable.

Due to technical progress, all designs, specifications and components are subject to change without notice.

WWW.SAMTEC.COM

All parts within this catalog are built to Samtec's specifications.

Customer specific requirements must be approved by Samtec and identified in a Samtec customer-specific drawing to apply.



BQRA-92SPP-02-10-0200

BQRA SERIES

20 GHz QUAD ROW TEST ASSEMBLY

SPECIFICATIONS

For complete specifications see www.samtec.com?BQRA

End 2 Connector:

Shell Material: Stainless Steel
Contact Material: BeCu

Cable Body: Stainless Steel
Insulator Material: Ultem 1000

Operating Temperature: -65 °C to +165 °C

Impedance: 50 Ω

Frequency Range: 20 GHz

RoHS Compliant: Yes

MWC-2350-01

Cable:

Cable Type: Low Loss Microwave Coax

Gauge: 23 AWG

Shield Material:
1. Flat silver plated copper
2. Silver plated copper braid

Dielectric: Solid FEP

Jacket Material: FEP

Bend Radius: 12 mm

Impedance: 50 Ω ± 1 Ω

COMPONENTS

- For replacement cable see www.samtec.com?BE23S
- For replacement block see www.samtec.com?BQR
- Replacement elastomer gaskets available
Contact Samtec.

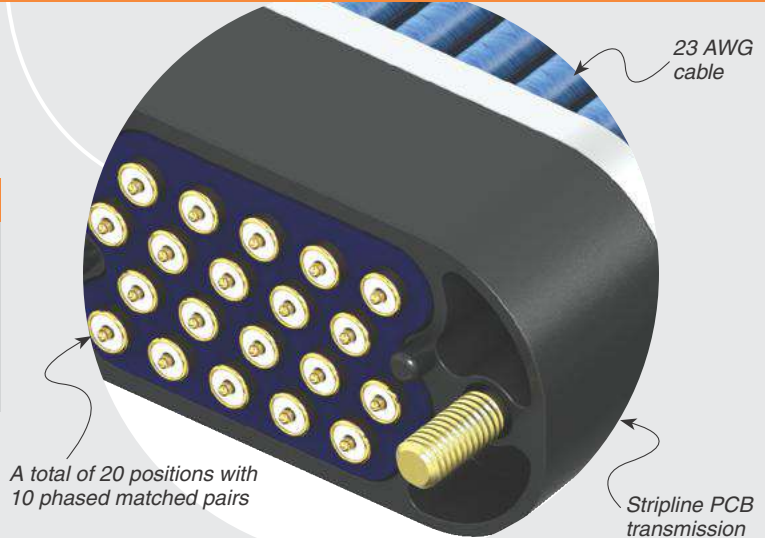

A total of 20 positions with 10 phased matched pairs

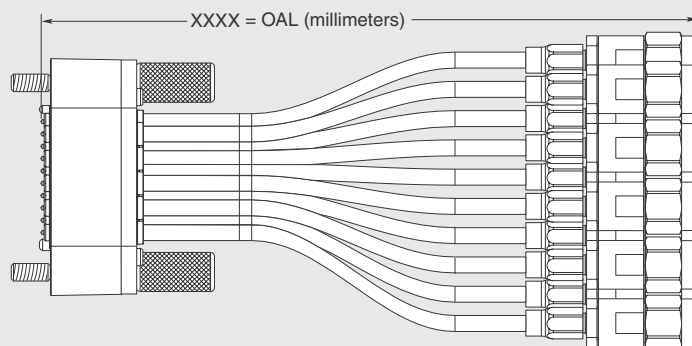
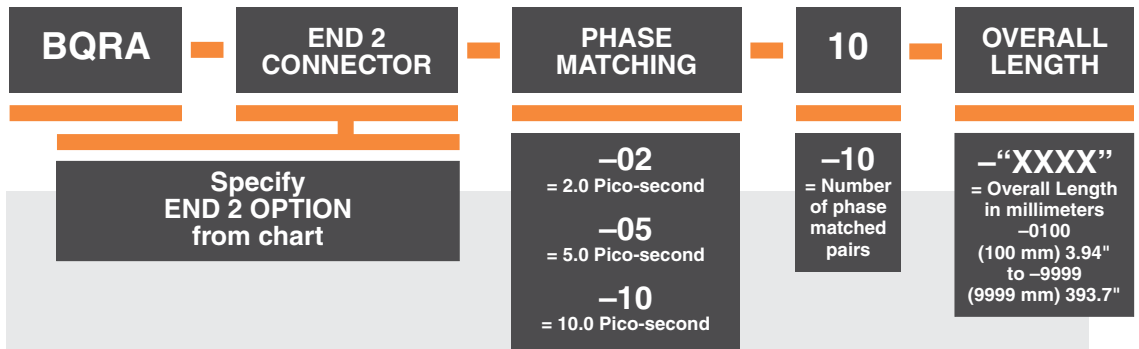

| END 2 OPTIONS | |
|---|--|
| <p>92SJP = 2.92 mm Straight Jack (30 μ" (0.76 μm) Gold on Center Contact, Stainless Steel on Shell)</p> | |
| <p>-92SPP = 2.92 mm Straight Plug (30 μ" (0.76 μm) Gold on Center Contact, Stainless Steel on Shell)</p> | |

Patent:
7544093

Note:
Some lengths, styles and options are non-standard, non-returnable.

Due to technical progress, all designs, specifications and components are subject to change without notice.

WWW.SAMTEC.COM

All parts within this catalog are built to Samtec's specifications. Customer specific requirements must be approved by Samtec and identified in a Samtec customer-specific drawing to apply.

REPLACEMENT COMPONENTS

Testing can be a long, arduous process and engineers need an assembly that will stand up to the demands. Yet, even the best components have a life cycle. As a result, Samtec makes it easy to order replacement components for our Bulls Eye® assemblies. The following outlines each replacement component, and in which assembly it is used:

| SERIES | COMPONENT | ASSEMBLY USED IN |
|--------|-----------|------------------|
| BE40B | Block | BE40A |
| BE40C | Cable | BE40A |
| BDR | Block | BDRA |
| BQR | Block | BQRA |
| BE23S | Cable | BDRA and BQRA |
| | Elastomer | BDRA and BQRA |

BULLSEYE
TEST POINT SYSTEM

samtec.com/BullsEye

To find these replacement components on our website, simply type the series name into the search box in the upper, right-hand corner of samtec.com. Contact RFTechnicalGroup@samtec.com for additional information.

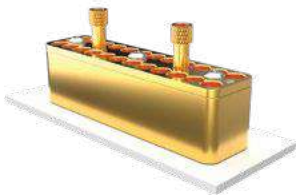

BE40B SERIES | Replacement block for 50 GHz Bulls Eye® (BE40A)

- Microstrip or stripline PCB transmission
- Double row



BE40C SERIES | Replacement cable for 50 GHz Bulls Eye® (BE40A)

- Pogo-pin design with ground/signal/ground
- 23 AWG solid dielectric low loss cable with additional copper foil shield

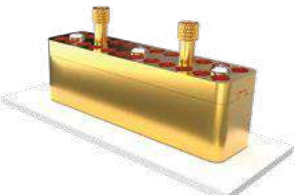

BDR SERIES | Replacement block for 20 GHz Bulls Eye® (BDRA)

- Stripline PCB transmission
- Double row



BQR SERIES | Replacement block for 20 GHz Bulls Eye® (BDRA)

- Stripline PCB transmission
- Quad row



BE23S SERIES | Replacement cable for 20 GHz Bulls Eye® (BDRA, BQRA)

- Fixed-pin design
- 23 AWG solid dielectric low loss cable

Due to technical progress, all designs, specifications and components are subject to change without notice.

WWW.SAMTEC.COM

All parts within this catalog are built to Samtec's specifications.
Customer specific requirements must be approved by Samtec and identified in a Samtec customer-specific drawing to apply.



50 Ω & 75 Ω CABLE ASSEMBLIES

MICRO HIGH FREQUENCY

| | |
|---|----|
| 50 Ω RF Cable Assembly, 0.81 mm Diameter (MH081)..... | 22 |
| 50 Ω RF Cable Assembly, 1.31 mm Diameter (MH113)..... | 23 |

50 Ω CABLE ASSEMBLIES

| | |
|---|-------|
| RF Cable Assembly, RG 174 Cable (RF174) | 24-25 |
| RF Cable Assembly, RG 178 Cable (RF178) | 26-27 |
| RF Cable Assembly, RG 316 Cable (RF316) | 28-29 |
| RF Cable Assembly, Double Shielded RG 316 Cable (RS316)..... | 30 |
| RF Cable Assembly, RG 58 Cable (RF058) | 31 |
| 24 AWG Semi-Flexible RF Cable Assembly, (.086" DIA) (RF405)..... | 32 |
| 19 AWG Semi-Flexible RF Cable Assembly, (.141" DIA) (RF402) | 33 |
| 50 GHz RF Cable Assembly, 23 AWG (RF23C)..... | 34-35 |
| 20 GHz RF Cable Assembly, 23 & 25 AWG (RF23S & RF25S) | 36 |

75 Ω CABLE ASSEMBLIES

| | |
|---|-------|
| RF Cable Assembly, RG 6 Cable, 1694A Cable (RFA6T, RFB6T) | 37 |
| RF Cable Assembly, RG 179 Cable (RF179) | 38-39 |
| RF Cable Assembly, 1855A Cable (RFB8T)..... | 40 |

APPLICATIONS

| | |
|-------------------------------|-------|
| 50 Ω Cables & Connectors..... | 8-9 |
| 75 Ω Cables & Connectors..... | 10-11 |

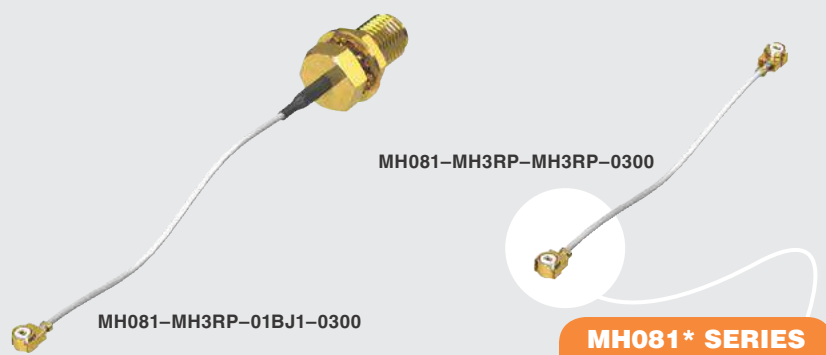

MH081* SERIES

MICRO HIGH FREQUENCY RF CABLES

SPECIFICATIONS

For complete specifications see www.samtec.com?MH081

- Outer Contact Material:** Au plated Phosphor Bronze
- Center Contact Material:** Au plated Phosphor Bronze (MHX)
- Insulator Material:** PBT (MHX) PTFE (SMA)
- Operating Temperature:** -40 °C to +90 °C
- Voltage Rating:** 170 V max
- Dielectric Withstanding Voltage:** 200 Vrms
- Frequency Range:** 0-6 GHz
- Impedance:** 50 Ω
- RoHS Compliant:** Yes

0.81 mm Cable:

- Impedance:** 50 Ω
- Capacitance:** 100 pF/meter
- Max Attenuation (cable only):** 3.1 dB @ 1 GHz
- Conductor Size:** 36 AWG, (0.81 mm) .032" dia.
- Conductor Material:** Silver Plated Copper
- Conductor Resistance:** 1.40 Ω/meter max
- Insulator Diameter:** (0.4 mm) .016"
- Insulator Material:** FEP
- Shield Material:** Silver Plated Copper
- Jacket Material:** PFA
- Jacket Diameter:** (0.81 mm) .032" dia.
- Bend Radius:** 5.0 mm
- Jacket Temp Rating:** -40 °C to +90 °C
- RoHS Compliant:** Yes

ALSO AVAILABLE (MOQ Required)

- Additional stripping and tinning options
 - Additional end connector combinations
 - Overall lengths
- Contact Samtec.

EXTRACTION TOOLS

- -MH1RP = RSP-122893-01
- -MH3RP = RSP-122893-02

APPLICATION

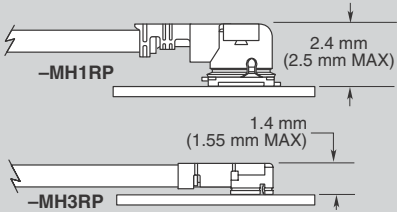

U.F.L and W.F.L Types

Micro High Frequency RF, MHF or SMA Bulkhead

(0.81 mm) .032" Diameter Cable

Mating PCB connectors available

MATING SOLUTIONS

- Micro RF PCB connectors for Micro High Frequency RFs
- MH1RP end mates with RSP-122811-01 (Cycles: 30 max.)
- MH3RP end mates with RSP-122811-02

MH081

END 1 CONNECTOR

END 2 CONNECTOR

OVERALL LENGTH

Specify END OPTIONS from chart

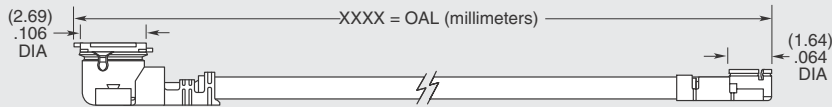

-0030
= 1.18" (30 mm)

-0050
= 1.97" (50 mm)

-0100
= 3.94" (100 mm)

-0150
= 5.91" (150 mm)

-0300
= 11.81" (300 mm)

END OPTIONS

| | |
|---|--|
| -MH1RP = MHF1 Type Plug (3.9 μ" (.1 μm) Gold on Center Contact, 1.9 μ" (.05 μm) Gold on Shell) | |
| -MH3RP = MHF3 Type Plug (3.9 μ" (.1 μm) Gold on Center Contact, 1.9 μ" (.05 μm) Gold on Shell) | |
| -01BJ1 = SMA Straight Bulkhead Jack -01BJ2 = SMA Straight Bulkhead Jack, Reversed Polarity | |
| -01SB1 = SMA Straight Jack, Sealed Bulkhead -01SR1 = SMA Straight Jack, Sealed Bulkhead, Reversed Polarity | |
| (30 μ" (0.76 μm) Gold on Center Contact, Gold Flash on Shell) | |
| -SING = Single Ended (End 2 callout) | |
| XXXXXX = Stripped & Tinned (End 2 callout) | |

STRIPPED & TINNED (Dimensions in mm)

| CALLOUT | A | B | C |
|---------|-----|-----|-----|
| -303030 | 3.0 | 3.0 | 3.0 |
| -303040 | 3.0 | 3.0 | 4.0 |
| -403030 | 4.0 | 3.0 | 3.0 |
| -403040 | 4.0 | 3.0 | 4.0 |
| -404040 | 4.0 | 4.0 | 4.0 |

Both center conductor and braid shield are stripped, only the center conductor is tinned.

* MH081 Series was previously RF081 Series

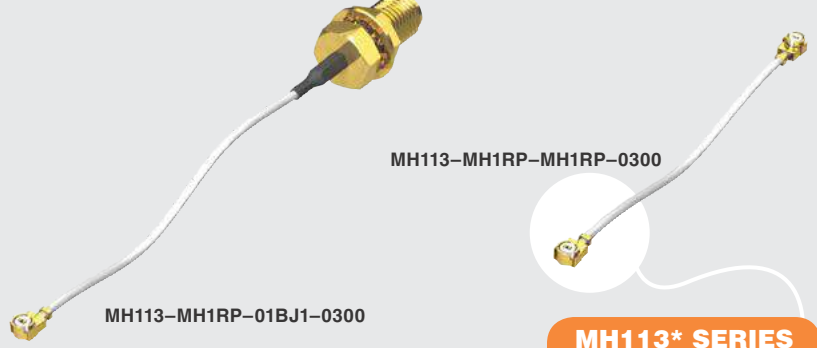

MH113* SERIES

MICRO HIGH FREQUENCY RF CABLES

SPECIFICATIONS

For complete specifications see www.samtec.com?MH113

- Outer Contact Material:** Au plated Phosphor Bronze
- Center Contact Material:** Au plated Phosphor Bronze (MHX)
- Au plated BeCu (SMA)**
- Insulator Material:** PBT (MHX) PTFE (SMA)
- Operating Temperature:** -40 °C to +90 °C
- Voltage Rating:** 170 V max
- Dielectric Withstanding Voltage:** 200 Vrms
- Frequency Range:** 0-6 GHz
- Impedance:** 50 Ω
- RoHS Compliant:** Yes

- 1.13 mm Cable:**
- Impedance:** 50 Ω
- Capacitance:** 95 pF/meter
- Max Attenuation (cable only):** 2 dB @ 1 GHz
- Conductor Size:** 32 AWG, (1.13 mm) .045" dia.
- Conductor Material:** Silver Plated Copper
- Conductor Resistance:** 0.60 Ω/meter max
- Insulator Diameter:** (0.66 mm) .026"
- Insulator Material:** FEP
- Shield Material:** Tinned Copper
- Jacket Material:** FEP
- Jacket Diameter:** (1.13 mm) .045" dia
- Bend Radius:** 6.8 mm
- Jacket Temp Rating:** -40 °C to +90 °C
- RoHS Compliant:** Yes

ALSO AVAILABLE (MOQ Required)

- Additional stripping and tinning options
 - Additional end connector combinations
 - Overall lengths
- Contact Samtec.

EXTRACTION TOOL

- -MH1RP = RSP-122893-01

* MH113 Series was previously RF113 Series

APPLICATION

-MH1RP

MATING SOLUTIONS

- Micro RF PCB connectors for Micro High Frequency RFs
- MH1RP end mates with RSP-122811-01 (Cycles: 30 max.)

MH113

END 1 CONNECTOR

END 2 CONNECTOR

OVERALL LENGTH

Specify END OPTIONS from chart

END OPTIONS

| | |
|---|--|
| -MH1RP = MHF1 Type Plug (3.9 μ" (.1 μm) Gold on Center Contact, 1.9 u" (.05 μm) Gold on Shell) | |
| -01BJ1 = SMA Straight Bulkhead Jack -01BJ2 = SMA Straight Bulkhead Jack, Reversed Polarity -01SB1 = SMA Straight Jack, Sealed Bulkhead -01SR1 = SMA Straight Jack, Sealed Bulkhead, Reversed Polarity (30 μ" (0.76 μm) Gold on Center Contact, Gold Flash on Shell) | |
| -SING = Single Ended (End 2 callout) | |
| XXXXXX = Stripped & Tinned (End 2 callout) | |

STRIPPED & TINNED (Dimensions in mm)

| CALLOUT | A | B | C |
|---------|-----|-----|-----|
| -303030 | 3.0 | 3.0 | 3.0 |
| -303040 | 3.0 | 3.0 | 4.0 |
| -403030 | 4.0 | 3.0 | 3.0 |
| -403040 | 4.0 | 3.0 | 4.0 |
| -404040 | 4.0 | 4.0 | 4.0 |

Both center conductor and braid shield are stripped, only the center conductor is tinned.

RF174-07SP1-01BJ1-0300



RF174-01RP1-02RP1-0200

50 Ω RG 174 CABLE ASSEMBLIES

SPECIFICATIONS

For complete specifications see www.samtec.com?RF174

RF Connector:

Outer Contact Material:

Ni plated Brass (BNC)
Au plated Brass (SMB & SMA)
Au plated BeCu (MCX & MMCX)

Center Contact Material:

Au plated Brass (BNC-P, MCX-P, MMCX-P & SMA-P)
Au plated BeCu (SMB-P & SMA-J)
Au plated Phos. Bronze (BNC-J)

Insulator Material:

PTFE

Operating Temperature:

-50 °C to +90 °C

Impedance:

50 Ω

Frequency Range:

0-6 GHz
(Cable & connector dependent)

RoHS Compliant:

Yes

RG 174 Cable:

Impedance:

50 Ω

Capacitance:

101.024 pF/meter

Max Attenuation

(cable only):
1.4 dB @ 1 GHz for 1 meter

Conductor Size:

26 AWG, (0.48 mm) .019" dia.

Conductor Material:

Copper

Insulator Material:

KLPE

Shield Material:

Tin Copper

Jacket Material:

PVC

Jacket Diameter:

(2.70 mm) .106"

Jacket Color:

Black

Bend Radius:

25.4 mm

RoHS Compliant:

Yes

Mates with:

MCX, MMCX, MMCXV,
SMA, SMB5, BNC5,
TNC



Solutionator
DESIGN IN A MINUTE

- Create a full system: cable assembly and board level mates, 50 Ω and 75 Ω solutions
- 24-hour samples on standard products
- Visit: rf.samtec.com

Standard performance 26 AWG
RG 174 coax cable

2.3dK

Plugs and
Jacks

Straight or
Right-angle

Single or
Double Ended

CABLE TYPE

END 1
CONNECTOR

END 2
CONNECTOR

RF174
= RG 174 Cable

Specify END OPTIONS from chart

-01SP1-01RP1 SHOWN

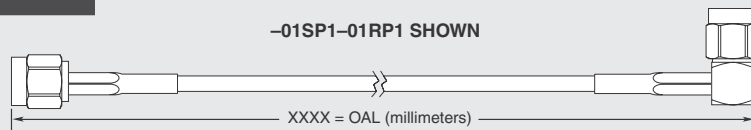

| END OPTIONS | |
|---|--|
| -01SP1 = SMA Straight Plug (30 μ" (0.76 μm) Gold on Center Contact, Gold Flash on Shell) | |
| -01RP1 = SMA Right-angle Plug (30 μ" (0.76 μm) Gold on Center Contact, Gold Flash on Shell) | |
| -07SP1 = SMB Straight Plug (30 μ" (0.76 μm) Gold on Center Contact, Gold Flash on Shell) | |
| -07RP1 = SMB Right-angle Plug (30 μ" (0.76 μm) Gold on Center Contact, Gold Flash on Shell) | |
| -02SJ1 = MCX Straight Jack (30 μ" (0.76 μm) Gold on Center Contact, Gold Flash on Shell) | |

| END OPTIONS | |
|---|--|
| -02RP1 = MCX Right-angle Plug (30 μ" (0.76 μm) Gold on Center Contact, Gold Flash on Shell) | |
| -02SP1 = MCX Straight Plug (30 μ" (0.76 μm) Gold on Center Contact, Gold Flash on Shell) | |
| -03SP1 = MMCX Straight Plug (30 μ" (0.76 μm) Gold on Center Contact, Gold Flash on Shell) | |
| -03RP1 = MMCX Right-angle Plug (30 μ" (0.76 μm) Gold on Center Contact, Gold Flash on Shell) | |
| -V3SP1 = MMCXV Straight Plug, High Vibration (30 μ" (0.76 μm) Gold on Center Contact, Nickel on Shell) | |
| -V3RP1 = MMCXV Right-angle Plug, High Vibration (30 μ" (0.76 μm) Gold on Center Contact, Nickel on Shell) | |
| -V3SJ1 = MMCXV Straight Jack, High Vibration (30 μ" (0.76 μm) Gold on Center Contact, Nickel on Shell) | |

Due to technical progress, all designs, specifications and components are subject to change without notice.

WWW.SAMTEC.COM

All parts within this catalog are built to Samtec's specifications.

Customer specific requirements must be approved by Samtec and identified in a Samtec customer-specific drawing to apply.

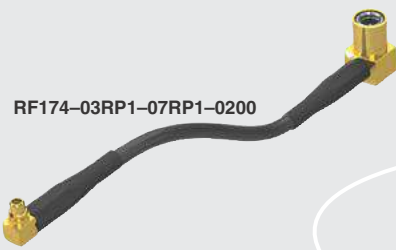

RF174-03RP1-07RP1-0200

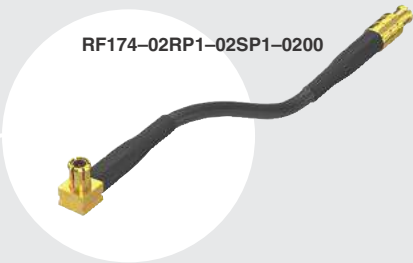

RF174-02RP1-02SP1-0200



RF174-04BJ2-07SP1-0100

RF174 SERIES



ALSO AVAILABLE (MOQ Required)

- Additional stripping and tinning options
 - IP67 TNC option
 - Additional plating options
 - Additional end connector combinations
 - Knurled nuts with BNC option
- Contact Samtec.



OTHER SOLUTIONS

- Cable connector kits (see cable components catalog pages)

OVERALL LENGTH

—“XXXX”

= Overall Length in millimeters -0100 (100 mm) minimum
(Cable lengths larger than 1000 millimeters are not supported by S.I. Test data)

| END OPTIONS | | END OPTIONS | | END OPTIONS | | | | | | | | | | | | | | | | | | | | | | | | |
|--|-----|--|-----|---|---------|---|---|---|---------|-----|-----|-----|---------|-----|-----|-----|---------|-----|-----|-----|---------|-----|-----|-----|---------|-----|-----|-----|
| <p>-04SP3 = BNC Straight Plug (10 μ" (0.25 μm) Gold on Center Contact, Nickel on Shell)</p> | | <p>-01PN1 = SMA 4-Hole Panel Mount Jack (30 μ" (0.76 μm) Gold on Center Contact, Gold Flash on Shell)</p> | | <p>-SING = Single Ended (End 2 Callout)</p> | | | | | | | | | | | | | | | | | | | | | | | | |
| <p>-05SP3 = TNC Straight Plug (10 μ" (0.25 μm) Gold on Center Contact, Nickel on Shell)</p> | | <p>-04BJ2 = BNC Bulkhead Jack (30 μ" (0.76 μm) Gold on Center Contact, Nickel on Shell)</p> | | <p>XXXXXX = Stripped & Tinned (End 2 Callout)</p> | | | | | | | | | | | | | | | | | | | | | | | | |
| <p>-07BJ1 = SMB Bulkhead Jack (30 μ" (0.76 μm) Gold on Center Contact, Gold flash on Shell)</p> | | <p>-05BJ3 = TNC Bulkhead Jack (10 μ" (0.25 μm) Gold on Center Contact, Nickel on Shell)</p> | | <p>STRIPPED & TINNED (Dimensions in mm)</p> <table border="1"> <thead> <tr> <th>CALLOUT</th> <th>A</th> <th>B</th> <th>C</th> </tr> </thead> <tbody> <tr> <td>-303030</td> <td>3.0</td> <td>3.0</td> <td>3.0</td> </tr> <tr> <td>-303040</td> <td>3.0</td> <td>3.0</td> <td>4.0</td> </tr> <tr> <td>-403030</td> <td>4.0</td> <td>3.0</td> <td>3.0</td> </tr> <tr> <td>-403040</td> <td>4.0</td> <td>3.0</td> <td>4.0</td> </tr> <tr> <td>-404040</td> <td>4.0</td> <td>4.0</td> <td>4.0</td> </tr> </tbody> </table> <p>Both center conductor and braid shield are stripped, only the center conductor is tinned.</p> | CALLOUT | A | B | C | -303030 | 3.0 | 3.0 | 3.0 | -303040 | 3.0 | 3.0 | 4.0 | -403030 | 4.0 | 3.0 | 3.0 | -403040 | 4.0 | 3.0 | 4.0 | -404040 | 4.0 | 4.0 | 4.0 |
| CALLOUT | A | B | C | | | | | | | | | | | | | | | | | | | | | | | | | |
| -303030 | 3.0 | 3.0 | 3.0 | | | | | | | | | | | | | | | | | | | | | | | | | |
| -303040 | 3.0 | 3.0 | 4.0 | | | | | | | | | | | | | | | | | | | | | | | | | |
| -403030 | 4.0 | 3.0 | 3.0 | | | | | | | | | | | | | | | | | | | | | | | | | |
| -403040 | 4.0 | 3.0 | 4.0 | | | | | | | | | | | | | | | | | | | | | | | | | |
| -404040 | 4.0 | 4.0 | 4.0 | | | | | | | | | | | | | | | | | | | | | | | | | |
| <p>-01BJ1 = SMA Straight Bulkhead Jack -01SB1 = SMA Straight Bulkhead Jack, Sealed -01SR1 = SMA Straight Bulkhead Jack, Sealed, Reversed Polarity -01BR1 = SMA Straight Bulkhead Jack, Reversed Polarity (30 μ" (0.76 μm) Gold on Center Contact, Gold Flash on Shell)</p> | | <p>-06BJ2 = N Type Bulkhead Jack (30 μ" (0.76 μm) Gold on Center Contact, Nickel on Shell)</p> | | | | | | | | | | | | | | | | | | | | | | | | | | |

Due to technical progress, all designs, specifications and components are subject to change without notice.

WWW.SAMTEC.COM

All parts within this catalog are built to Samtec's specifications.
Customer specific requirements must be approved by Samtec and identified in a Samtec customer-specific drawing to apply.

RF178-02RP1-01BJ1-0200



RF178-02SP1-02RP1-0300

50 Ω RG 178 CABLE ASSEMBLIES

SPECIFICATIONS

For complete specifications see www.samtec.com?RF178

RF Connector:

Outer Contact Material:
Au plated Brass (SMA & SMB)
Au plated BeCu (MCX & MMCX)
Nickel (BNC & TNC)

Center Contact Material:

Au plated Brass
(MCX-P, MMCX-P, BNC,
TNC & SMB)

Au plated BeCu
(SMA-J & MCX-J)

Insulator Material:

PTFE

Operating Temperature:

-50 °C to +165 °C

Frequency Range:

0-5 GHz
(Connector dependent)

Impedance:

50 Ω

RoHS Compliant:

Yes

RG 178 Cable:

Impedance:

50 Ω

Capacitance:

96 pF/meter

Propagation Delay:

4.83 nsec/meter

Max Attenuation

(cable only):

1.7 dB @ 1 GHz for 1 meter

Conductor Size:

30 AWG, (0.31 mm) .012" dia.

Conductor Material:

Silver Plated Copper

Conductor Resistance:

0.34 Ω/meter max

Current Rating:

3 A DC

Insulator Diameter:

(0.86 mm) .034"

Insulator Material:

PTFE

Dielectric Constant:

2.1 dK

Shield Material:

Silver Plated Copper Clad Steel

Jacket Material:

FEP

Jacket Diameter:

(1.80 mm) .071"

Jacket Temp Rating:

-50 °C to +165 °C

Jacket Color:

Amber

Bend Radius:

10.2 mm

RoHS Compliant:

Yes

Mates with:

MCX, MMCX, BNC5,
TNC, SMA, SMB5



Solutionator
DESIGN IN A MINUTE

- Create a full system: cable assembly and board level mates, 50 Ω and 75 Ω solutions
- 24-hour samples on standard products
- Visit: rf.samtec.com

Light Gauge 30 AWG
RG 178 coax cable

2.1dK

Standard Heat
Shrink

SMA, MCX, MMCX,
SMB, BNC, TNC and
N Type End Options

CABLE TYPE

END 1
CONNECTOR

END 2
CONNECTOR

RF178
= RG 178 Cable

Specify END OPTIONS from chart

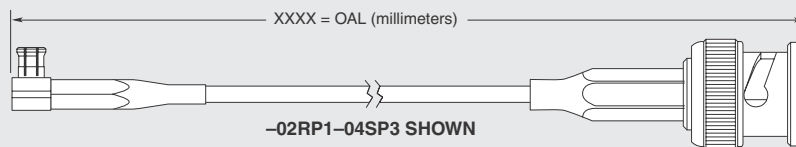

| END OPTIONS | | END OPTIONS | |
|--|--|--|--|
| <p>-01BJ1 = SMA Straight Bulkhead Jack -01BR1 = SMA Straight Bulkhead Jack, Reversed Polarity</p> <p>(30 μ" (0.76 μm) Gold on Center Contact, Gold Flash on Shell)</p> | | <p>-02SP1 = MCX Straight Plug (30 μ" (0.76 μm) Gold on Center Contact, Gold Flash on Shell)</p> | |
| <p>-02SJ1 = MCX Straight Jack (30 μ" (0.76 μm) Gold on Center Contact, Gold Flash on Shell)</p> | | <p>-03SP1 = MMCX Straight Plug (30 μ" (0.76 μm) Gold on Center Contact, Gold Flash on Shell)</p> | |
| <p>-02RP1 = MCX Right-angle Plug (30 μ" (0.76 μm) Gold on Center Contact, Gold Flash on Shell)</p> | | <p>-03RP1 = MMCX Right-angle Plug (30 μ" (0.76 μm) Gold on Center Contact, Gold Flash on Shell)</p> | |

Due to technical progress, all designs, specifications and components are subject to change without notice.

WWW.SAMTEC.COM

All parts within this catalog are built to Samtec's specifications.

Customer specific requirements must be approved by Samtec and identified in a Samtec customer-specific drawing to apply.

RF178-04SP3-02SJ1-0100

RF178-01BJ1-03RP1-0200

RF178-07BJ2-03SP1-0200

RF178 SERIES

Straight or Right-angle

Variety of Bulkhead Jacks

Single or Double ended

ALSO AVAILABLE
(MOQ Required)

- Additional stripping and tinning options
 - IP67 TNC option
 - Additional plating options
 - Additional end connector combinations
- Contact Samtec.



OTHER SOLUTIONS

- Cable connector kits (see cable components catalog pages)

OVERALL LENGTH

—“XXXX”

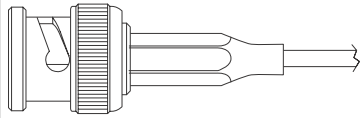
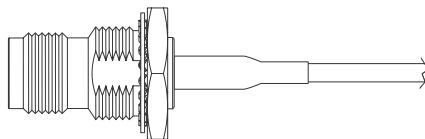
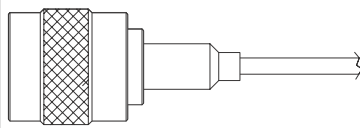
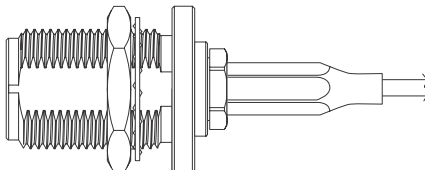
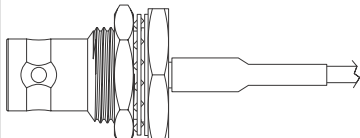
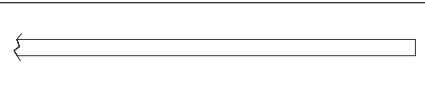
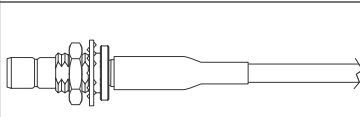
= Overall Length in millimeters -0100 (100 mm) 3.94" minimum

| END OPTIONS | | END OPTIONS | |
|---|--|---|--|
| <p>-04SP3 = BNC Straight Plug (10 μ" (0.25 μm)) Gold on Center Contact, Nickel on Shell</p>  | | <p>-05BJ3 = TNC Straight Bulkhead Jack (10 μ" (0.25 μm)) Gold on Center Contact, Nickel on Shell</p>  | |
| <p>-05SP3 = TNC Straight Plug (10 μ" (0.25 μm)) Gold on Center Contact, Nickel on Shell</p>  | | <p>-06BJ2 = N Type Straight Bulkhead Jack (30 μ" (0.76 μm)) Gold on Center Contact, Nickel on Shell</p>  | |
| <p>-04BJ2 = BNC Straight Bulkhead Jack (30 μ" (0.76 μm)) Gold on Center Contact, Nickel on Shell</p>  | | <p>-SING = Single Ended (End 2 Callout)</p>  | |
| <p>-07BJ2 = SMB Straight Bulkhead Jack (30 μ" (0.76 μm)) Gold on Center Contact, Nickel on Shell</p>  | | <p>XXXXXX = Stripped & Tinned (End 2 Callout)</p>  | |

STRIPPED & TINNED
(Dimensions in mm)

| CALLOUT | A | B | C |
|---------|-----|-----|-----|
| -303030 | 3.0 | 3.0 | 3.0 |
| -303040 | 3.0 | 3.0 | 4.0 |
| -403030 | 4.0 | 3.0 | 3.0 |
| -403040 | 4.0 | 3.0 | 4.0 |
| -404040 | 4.0 | 4.0 | 4.0 |

Both center conductor and braid shield are stripped, only the center conductor is tinned.

Due to technical progress, all designs, specifications and components are subject to change without notice.

RF316-07SP1-01BJ1-0300

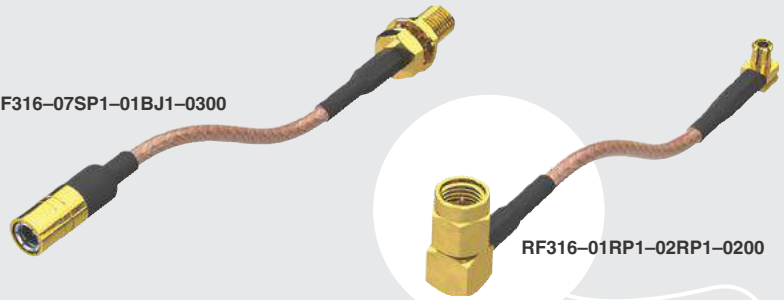

RF316-01RP1-02RP1-0200

50 Ω RG 316 CABLE ASSEMBLIES

SPECIFICATIONS

For complete specifications see www.samtec.com?RF316

RF Connector:

Outer Contact Material:

Ni plated Brass (BNC)
Au plated Brass (SMB & SMA)
Au plated BeCu (MCX & MMCX)

Center Contact Material:

Au plated Brass (BNC-P, MCX-P, MMCX-P & SMA-P)
Au plated BeCu (SMB-P & SMA-J)

Insulator Material:

PTFE
Au plated Phos. Bronze (BNC-J)

Operating Temperature:

-50 °C to +165 °C

Impedance:

50 Ω

Frequency Range:

0-6 GHz

(Cable & connector dependent)

RoHS Compliant:

Yes

RG 316 Cable:

Impedance:

50 Ω

Capacitance:

96.432 pF/meter

Max Attenuation

(cable only):

1.25 dB @ 1 GHz for 1 meter

Conductor Size:

26 AWG, (0.51 mm) .020" dia.

Conductor Material:

Silver Plated Copper

Insulator Material:

PTFE

Shield Material:

Silver Plated Copper Clad Steel

Jacket Material:

FEP

Jacket Diameter:

(2.54 mm) .100"

Jacket Color:

Amber

Bend Radius:

12.7 mm

RoHS Compliant:

Yes

Mates with:

MCX, MMCX, MMCXV,
SMA, SMB5, BNC5, TNC



Solutionator
DESIGN IN A MINUTE

- Create a full system: cable assembly and board level mates, 50 Ω and 75 Ω solutions
- 24-hour samples on standard products
- Visit: rf.samtec.com

Plugs and Jacks

High performance 26 AWG
RG 316 coax cable

Straight or
Right-angle

Double shielded
RG 316 cable
also available
(RS316 Series)

CABLE TYPE

END 1 CONNECTOR

END 2 CONNECTOR

RF316
= RG 316 Cable,
Single Braid Shield

Specify END OPTIONS from chart

-01SP1-02RP1 SHOWN

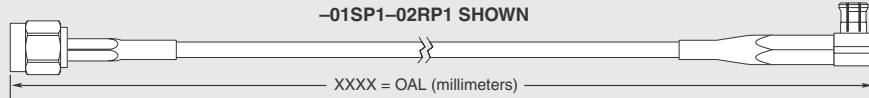

| END OPTIONS | |
|---|--|
| -01SP1 = SMA Straight Plug (30 μ" (0.76 μm) Gold on Center Contact, Gold Flash on Shell) | |
| -01RP1 = SMA Right-angle Plug (30 μ" (0.76 μm) Gold on Center Contact, Gold Flash on Shell) | |
| -07SP1 = SMB Straight Plug (30 μ" (0.76 μm) Gold on Center Contact, Gold Flash on Shell) | |
| -07RP1 = SMB Right-angle Plug (30 μ" (0.76 μm) Gold on Center Contact, Gold Flash on Shell) | |
| -02SJ1 = MCX Straight Jack (30 μ" (0.76 μm) Gold on Center Contact, Gold Flash on Shell) | |

| END OPTIONS | |
|---|--|
| -02RP1 = MCX Right-angle Plug (30 μ" (0.76 μm) Gold on Center Contact, Gold Flash on Shell) | |
| -02SP1 = MCX Straight Plug (30 μ" (0.76 μm) Gold on Center Contact, Gold Flash on Shell) | |
| -03SP1 = MMCX Straight Plug (30 μ" (0.76 μm) Gold on Center Contact, Gold Flash on Shell) | |
| -03RP1 = MMCX Right-angle Plug (30 μ" (0.76 μm) Gold on Center Contact, Gold Flash on Shell) | |
| -V3SP1 = MMCXV Straight Plug, High Vibration (30 μ" (0.76 μm) Gold on Center Contact, Nickel on Shell) | |
| -V3RP1 = MMCXV Right-angle Plug, High Vibration (30 μ" (0.76 μm) Gold on Center Contact, Nickel on Shell) | |
| -V3SJ1 = MMCXV Straight Jack, High Vibration (30 μ" (0.76 μm) Gold on Center Contact, Nickel on Shell) | |

OTHER SOLUTIONS

- Double shielded RG 316 cable available, see RS316 Series
- Cable connector kits (see cable components catalog pages)

Due to technical progress, all designs, specifications and components are subject to change without notice.

WWW.SAMTEC.COM

All parts within this catalog are built to Samtec's specifications.

Customer specific requirements must be approved by Samtec and identified in a Samtec customer-specific drawing to apply.



RF316-03RP1-07RP1-0200



RF316-02RP1-02SP1-0200



RF316-04BJ2-07SP1-0100

RF316 SERIES

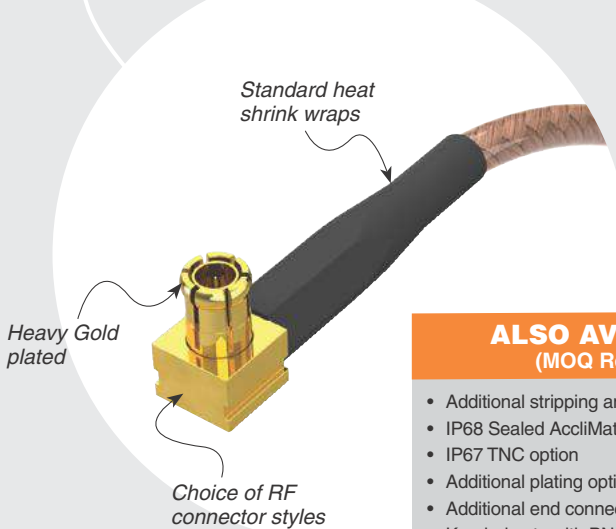

- ALSO AVAILABLE**
(MOQ Required)
- Additional stripping and tinning options
 - IP68 Sealed AccliMate™ end options
 - IP67 TNC option
 - Additional plating options
 - Additional end connector combinations
 - Knurled nuts with BNC option
- Contact Samtec.

OVERALL LENGTH

—“XXXX”

= Overall Length in millimeters -0100 (100 mm) minimum
(Cable lengths larger than 1000 millimeters are not supported by S.I. Test data)

| END OPTIONS | | END OPTIONS | | END OPTIONS | | | | | | | | | | | | | | | | | | | | | | | | |
|--|-----|---|-----|---|---------|---|---|---|---------|-----|-----|-----|---------|-----|-----|-----|---------|-----|-----|-----|---------|-----|-----|-----|---------|-----|-----|-----|
| <p>-04SP3 = BNC Straight Plug (10 μ" (0.25 μm) Gold on Center Contact, Nickel on Shell)</p> | | <p>-01PN1 = SMA 4-Hole Panel Mount Jack (30 μ" (0.76 μm) Gold on Center Contact, Gold Flash on Shell)</p> | | <p>-SING = Single Ended (End 2 Callout)</p> | | | | | | | | | | | | | | | | | | | | | | | | |
| <p>-05SP3 = TNC Straight Plug (10 μ" (0.25 μm) Gold on Center Contact, Nickel on Shell)</p> | | <p>-04BJ2 = BNC Bulkhead Jack (30 μ" (0.76 μm) Gold on Center Contact, Nickel on Shell)</p> | | <p>XXXXXX = Stripped & Tinned (End 2 Callout)</p> | | | | | | | | | | | | | | | | | | | | | | | | |
| <p>-07BJ1 = SMB Bulkhead Jack (30 μ" (0.76 μm) Gold on Center Contact, Gold Flash on Shell)</p> | | <p>-05BJ3 = TNC Bulkhead Jack (10 μ" (0.25 μm) Gold on Center Contact, Nickel on Shell)</p> | | <p>STRIPPED & TINNED (Dimensions in mm)</p> <table border="1"> <thead> <tr> <th>CALLOUT</th> <th>A</th> <th>B</th> <th>C</th> </tr> </thead> <tbody> <tr> <td>-303030</td> <td>3.0</td> <td>3.0</td> <td>3.0</td> </tr> <tr> <td>-303040</td> <td>3.0</td> <td>3.0</td> <td>4.0</td> </tr> <tr> <td>-403030</td> <td>4.0</td> <td>3.0</td> <td>3.0</td> </tr> <tr> <td>-403040</td> <td>4.0</td> <td>3.0</td> <td>4.0</td> </tr> <tr> <td>-404040</td> <td>4.0</td> <td>4.0</td> <td>4.0</td> </tr> </tbody> </table> <p>Both center conductor and braid shield are stripped, only the center conductor is tinned.</p> | CALLOUT | A | B | C | -303030 | 3.0 | 3.0 | 3.0 | -303040 | 3.0 | 3.0 | 4.0 | -403030 | 4.0 | 3.0 | 3.0 | -403040 | 4.0 | 3.0 | 4.0 | -404040 | 4.0 | 4.0 | 4.0 |
| CALLOUT | A | B | C | | | | | | | | | | | | | | | | | | | | | | | | | |
| -303030 | 3.0 | 3.0 | 3.0 | | | | | | | | | | | | | | | | | | | | | | | | | |
| -303040 | 3.0 | 3.0 | 4.0 | | | | | | | | | | | | | | | | | | | | | | | | | |
| -403030 | 4.0 | 3.0 | 3.0 | | | | | | | | | | | | | | | | | | | | | | | | | |
| -403040 | 4.0 | 3.0 | 4.0 | | | | | | | | | | | | | | | | | | | | | | | | | |
| -404040 | 4.0 | 4.0 | 4.0 | | | | | | | | | | | | | | | | | | | | | | | | | |
| <p>-01BJ1 = SMA Straight Bulkhead Jack -01SB1 = SMA Straight Bulkhead Jack, Sealed -01SR1 = SMA Straight Bulkhead Jack, Sealed, Reversed Polarity -01BR1 = SMA Straight Bulkhead Jack, Reversed Polarity (30 μ" (0.76 μm) Gold on Center Contact, Gold Flash on Shell)</p> | | <p>-06BJ2 = N Type Bulkhead Jack (30 μ" (0.76 μm) Gold on Center Contact, Nickel on Shell)</p> | | | | | | | | | | | | | | | | | | | | | | | | | | |

Due to technical progress, all designs, specifications and components are subject to change without notice.

WWW.SAMTEC.COM

All parts within this catalog are built to Samtec's specifications.
Customer specific requirements must be approved by Samtec and identified in a Samtec customer-specific drawing to apply.



RS316 SERIES

50 Ω DOUBLE SHIELDED RG 316 CABLE

SPECIFICATIONS

For complete specifications see www.samtec.com?RS316

RF Connector:

Outer Contact Material:
Ni plated Brass (BNC),
Au plated Brass (SMA),
Au plated BeCu (MCX, MMCX)

Center Contact Material:
Au plated Brass
(SMA, MCX, MMCX),
Au plated Phosphor Bronze
(BNC)

Insulator Material:
PTFE

Operating Temperature:
-50 °C to +165 °C

Impedance:
50 Ω

Frequency Range:
0-6 GHz
(Cable & connector dependent)

RoHS Compliant: Yes

RG 316 DS Cable:

Impedance:
50 Ω

Capacitance:
95.8 pF/meter

**Max Attenuation
(cable only):**
1.4 dB @ 2 GHz for 1 meter

Conductor Size:
26 AWG, (0.51 mm) .020" dia.

Conductor Material:
Silver Plated Copper
Clad Steel

Insulator Material: FEP

Shield 1 Material: Silver Plated Copper

Shield 2 Material: Silver Plated Copper

Jacket Material: FEP

Jacket Diameter:
(2.90 mm) .114"

Jacket Color: Amber

Bend Radius: 12.8 mm

RoHS Compliant: Yes

Mates with:
SMA, MCX,
MMCX, TNC, BNC5



- Create a full system: cable assembly and board level mates, 50 Ω and 75 Ω solutions
- 24-hour samples on standard products
- Visit: rf.samtec.com

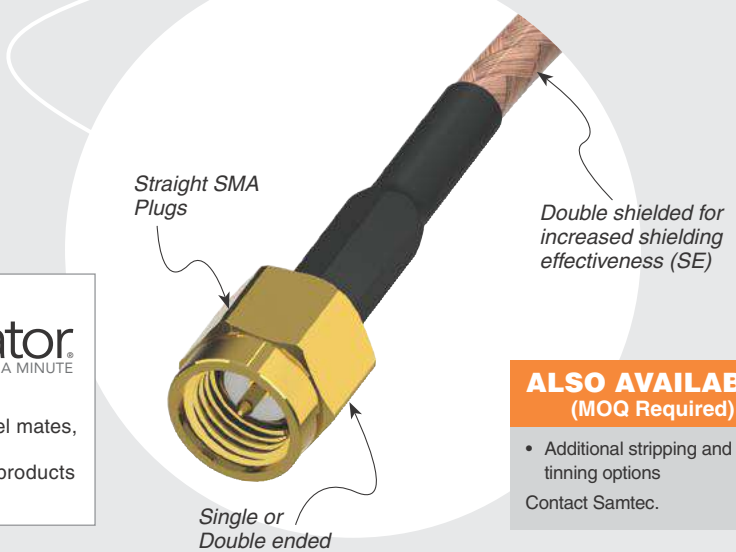

ALSO AVAILABLE (MOQ Required)

- Additional stripping and tinning options
- Contact Samtec.

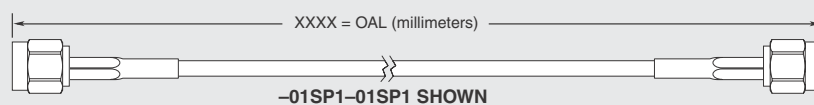

OTHER SOLUTIONS

- Single shielded RG 316 cable available, see RF316 Series
- Cable connector kits (see cable components catalog pages)

| END OPTIONS | |
|---|--|
| -01SP1 = SMA Straight Plug (30 μ" (0.76 μm) Gold on Center Contact, Gold Flash on Shell) | |
| 02SJ1 = MCX Straight Jack (30 μ" (0.76 μm) Gold on Center Contact, Gold Flash on Shell) | |
| -02SP1 = MCX Straight Plug (30 μ" (0.76 μm) Gold on Center Contact, Gold Flash on Shell) | |
| -03SP1 = MMCX Straight Plug (30 μ" (0.76 μm) Gold on Center Contact, Gold Flash on Shell) | |
| 05SP3 = TNC Straight Plug (10 μ" (0.25 μm) Gold on Center Contact, Nickel on Shell) | |

| END OPTIONS | |
|---|--|
| -01BJ1 = SMA Straight Bulkhead Jack (30 μ" (0.76 μm) Gold on Center Contact, Gold Flash on Shell) | |
| -04BJ2 = BNC Bulkhead Jack (30 μ" (0.76 μm) Gold on Center Contact, Nickel on Shell) | |
| SING = Single Ended (End 2 Callout) | |
| XXXXXX = Stripped & Tinned (End 2 Callout) | |

| STRIPPED & TINNED (Dimensions in mm) | | | |
|--------------------------------------|-----|-----|-----|
| CALLOUT | A | B | C |
| -303030 | 3.0 | 3.0 | 3.0 |
| -303040 | 3.0 | 3.0 | 4.0 |
| -403030 | 4.0 | 3.0 | 3.0 |
| -403040 | 4.0 | 3.0 | 4.0 |
| -404040 | 4.0 | 4.0 | 4.0 |

Both center conductor and braid shield are stripped, only the center conductor is tinned.

Due to technical progress, all designs, specifications and components are subject to change without notice.

RF058-01SP1-01SP1-0100



RF058-05SR3-05SR3-0100

RF058 SERIES

50 Ω RG 58 CABLE ASSEMBLIES

SPECIFICATIONS

For complete specifications see www.samtec.com?RF058

- RF Connector:**
Outer Contact Material:
 Ni plated Brass (TNC, N Type),
 Au plated Ni (SMA)
Center Contact Material:
 Au plated Ni (TNC, N Type),
 Au plated Brass (SMA)
Insulator Material:
 PTFE
Frequency Range:
 0~1 GHz
Impedance:
 50 Ω
RoHS Compliant:
 Yes
RG 58 Cable:
Impedance:
 50 Ω
Capacitance:
 102 pF/meter
Max Attenuation (cable only):
 0.8 dB @ 1 GHz
Conductor Size:
 20 AWG, (0.90 mm) .036" dia.
Conductor Material:
 Tinned Copper
Insulator Diameter:
 (3.00 mm) .076"
Insulator Material:
 Solid Polyethylene
Shield Material:
 Tinned Copper
Jacket Material:
 PVC
Jacket Diameter:
 (5.00 mm) .197" dia.
Bend Radius:
 48.3 mm
Jacket Temp Rating:
 -50 °C to +90 °C
RoHS Compliant:
 Yes

Mates with:
TNC, SMA



- Create a full system: cable assembly and board level mates, 50 Ω and 75 Ω solutions
- 24-hour samples on standard products
- Visit: rf.samtec.com

20 AWG
 RG 58 coax cable



Single or Double Ended

SMA, TNC or N Type end options

RF058

END 1 CONNECTOR

END 2 CONNECTOR

OVERALL LENGTH

Specify END OPTIONS from chart

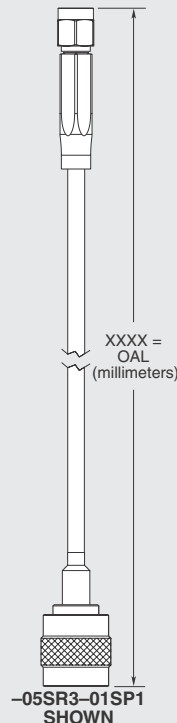

| END OPTIONS | |
|---|--|
| -01SP1 = SMA Straight Plug (30 μ" (0.76 μm) Gold on Center Contact, Gold Flash on Outer Contact and Shell) | |
| -05SR3 = TNC Reversed Polarity Straight Plug (10 μ" (0.25 μm) Gold on Center Contact, Nickel on Shell) | |
| -06SP3 = N Type Straight Plug (10 μ" (0.25 μm) Gold on Center Contact, Nickel on Shell) | |
| -01BJ1 = SMA Straight Bulkhead Jack -01SB1 = SMA Straight Bulkhead Jack, Sealed (30 μ" (0.76 μm) Gold on Center Contact, Gold Flash on Outer Contact and Shell) | |
| -SING = Single Ended (End 2 Callout) | |
| -XXXXXX = Stripped & Tinned (End 2 Callout) | |

–“XXXX”
 = Overall Length in millimeters
 –0100 (100 mm) 3.94" minimum

STRIPPED & TINNED (Dimensions in mm)

| CALLOUT | A | B | C |
|---------|-----|-----|-----|
| -303030 | 3.0 | 3.0 | 3.0 |
| -303040 | 3.0 | 3.0 | 4.0 |
| -403030 | 4.0 | 3.0 | 3.0 |
| -403040 | 4.0 | 3.0 | 4.0 |
| -404040 | 4.0 | 4.0 | 4.0 |

Both center conductor and braid shield are stripped, only the center conductor is tinned.

ALSO AVAILABLE (MOQ Required)

- Additional stripping and tinning options
 - Additional plating options
 - Additional end connector options
- Contact Samtec.

OTHER SOLUTIONS

- Cable connector kits (see cable components catalog pages)

Due to technical progress, all designs, specifications and components are subject to change without notice.

RF405-01SP1-01RP1-0500

RF405-00SJ7-00SJ7-0500

RF405 SERIES

50 Ω .086" DIA SEMI-FLEXIBLE CABLE

SPECIFICATIONS

For complete specifications see www.samtec.com?RF405

RF Connector:

Shell Material:
Brass (SMA),
Au plated BeCu (SMP)
Contact Material:
Brass (SMA),
Au plated BeCu (SMP)
Impedance:
50 Ω

Frequency Range:
DC to 20 GHz

Dielectric Withstanding:
1,000 Vrms (SMA),
500 Vrms min (SMP)

RG 405 (.086")

Cable:

Impedance:
50 Ω microwave
Capacitance:
104.97 pF/meter
Max Attenuation (cable only):
0.72 @ 1 GHz for 1 meter
Conductor Size:
24 AWG (0.56 mm) .022" dia.
Conductor Material:
Silver plated copper clad steel
Insulator Material:
PTFE
Shield Material:
Tinned Copper
Bend Radius:
3.18 mm
RoHS Compliant:
Yes

Mates with:
SMA, SMP



- Create a full system: cable assembly and board level mates, 50 Ω and 75 Ω solutions
- 24-hour samples on standard products
- Visit: rf.samtec.com

Hand-formable semi-flexible cable

(2.18 mm) .086" DIA cable

Choice of SMA or SMP terminations

CABLE TYPE

END 1 CONNECTOR

END 2 CONNECTOR

OVERALL LENGTH

RF405
= (2.18 mm) .086" DIA
24 AWG Semi-flexible
coax cable

Specify
END OPTIONS
from chart

– “XXXX”
= Overall Length in millimeters
–0100 (100 mm) 3.94" minimum

ALSO AVAILABLE (MOQ Required)

- Additional stripping and tinning options Contact Samtec.

OTHER SOLUTIONS

- Cable connector kits (see cable components catalog pages)

Note:
Cable lengths longer than (1000 mm) 39.40" are not supported with S.I. test data.

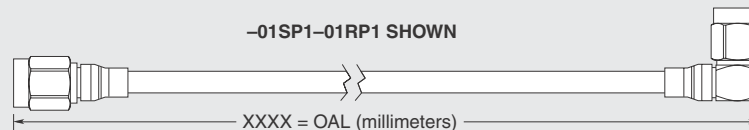

STRIPPED & TINNED (Dimensions in mm)

| CALLOUT | A | B |
|---------|-----|-----|
| -3030 | 3.0 | 3.0 |
| -4030 | 4.0 | 3.0 |
| -4040 | 4.0 | 4.0 |

Both center conductor and braid shield are stripped, only the center conductor is tinned.

| END OPTIONS | | END OPTIONS | |
|---|--|---|--|
| <p>-01SP1 = SMA Straight Plug (30 μ" (0.76 μm) Gold on Center Contact, Gold Flash on Shell)</p> | | <p>-00SJ7 = SMP Straight Jack (10 μ" (0.25 μm) Gold on Center Contact, Gold Flash on Shell)</p> | |
| <p>-01RP1 = SMA Right-angle Plug (30 μ" (0.76 μm) Gold on Center Contact, Gold Flash on Shell)</p> | | <p>-00RJ7 = SMP Right-angle Jack (10 μ" (0.25 μm) Gold on Center Contact, Gold Flash on Shell)</p> | |
| | | <p>XXXX = Stripped & Tinned (End 2 callout)</p> | |

Due to technical progress, all designs, specifications and components are subject to change without notice.



RF402 SERIES

50 Ω .141" DIA SEMI-FLEXIBLE CABLE

SPECIFICATIONS

For complete specifications see www.samtec.com?RF402

RF Connector:

Shell Material:

Brass

Contact Material:

Brass

Insulator Material:

PTFE

Impedance:

50 Ω

Frequency Range:

0-20 GHz

Dielectric Withstanding:

1,000 Vrms

RG 402 (.141")

Cable:

Impedance:

50 Ω microwave

Capacitance:

98.072 pF/meter

Max Attenuation

(cable only):

0.40 @ 1 GHz for 1 meter

Conductor Size:

19 AWG (0.92 mm) .036" dia.

Conductor Material:

Silver plated copper clad steel

Insulator Material:

PTFE

Shield Material:

Tinned Copper

Bend Radius:

6.35 mm

RoHS Compliant:

Yes

Mates with:

SMA



Solutionator
DESIGN IN A MINUTE

- Create a full system: cable assembly and board level mates, 50 Ω and 75 Ω solutions
- 24-hour samples on standard products
- Visit: rf.samtec.com

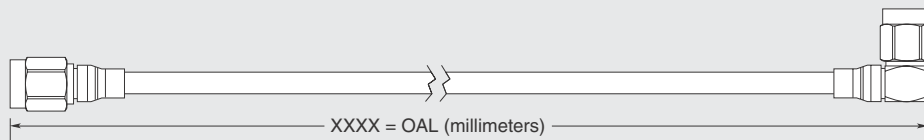
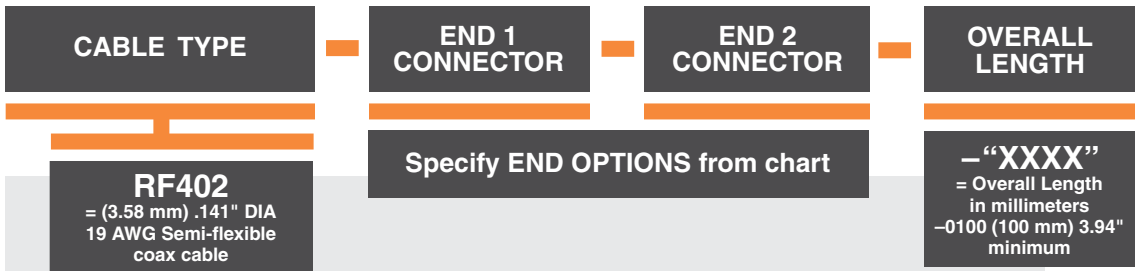
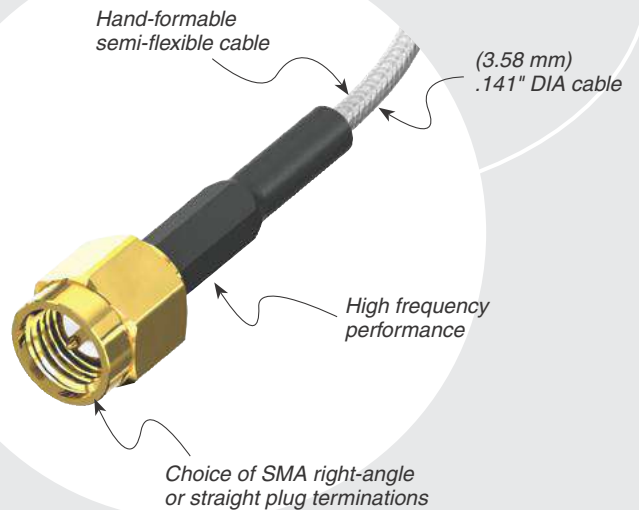

ALSO AVAILABLE (MOQ Required)

- Additional stripping and tinning options
- Contact Samtec.

OTHER SOLUTIONS

- Cable connector kits (see cable components catalog pages)

Note:
Cable lengths longer than (1000 mm) 39.40" are not supported with S.I. test data.

| END OPTIONS | |
|--|--|
| -01SP1 = SMA Straight Plug (30 μm (0.76 μm) Gold on Center Contact, Gold Flash on Shell) | |
| -01RP1 = SMA Right-angle Plug (30 μm (0.76 μm) Gold on Center Contact, Gold Flash on Shell) | |
| XXXX = Stripped & Tinned (End 2 callout) | |

STRIPPED & TINNED (Dimensions in mm)

| CALLOUT | A | B |
|---------|-----|-----|
| -3030 | 3.0 | 3.0 |
| -4030 | 4.0 | 3.0 |
| -4040 | 4.0 | 4.0 |

Both center conductor and braid shield are stripped, only the center conductor is tinned.

Due to technical progress, all designs, specifications and components are subject to change without notice.

WWW.SAMTEC.COM

All parts within this catalog are built to Samtec's specifications.

Customer specific requirements must be approved by Samtec and identified in a Samtec customer-specific drawing to apply.

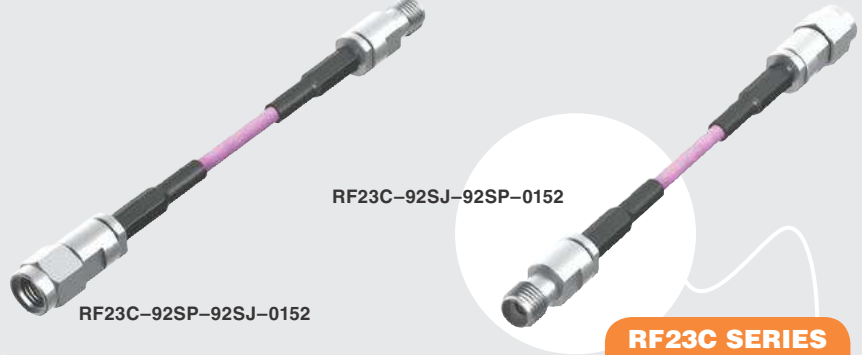

RF23C SERIES

50 Ω 50 GHz RF CABLE ASSEMBLY

SPECIFICATIONS

For complete specifications see www.samtec.com?RF23C

RF Connector:

Shell Material:
Stainless Steel
Contact Material:
BeCu

Cable Body:
Stainless Steel

Insulator Material:
Ultem 1000

Operating Temperature:
-40 °C to +85 °C

Impedance:
50 Ω

Frequency Range:
50 GHz

RoHS Compliant:
Yes

MWC-2350CU-01

Cable:

Type:
Low Loss Microwave Coax

Gauge:
23 AWG

Shield Material:
1. Flat silver plated copper
2. Copper tape
3. Silver plated copper braid

Dielectric:
Solid FEP

Jacket Material:
FEP

Bend Radius:
6 mm

Impedance:
50 Ω ± 1 Ω

Propagation Delay:
4.76 nsec/meter

Capacitance:
97.80 pF/meter

Mates with:
292

Robust in
dynamic applications

TEST REPORTS

Visit www.samtec.com?RF23C or contact RFTechnicalGroup@samtec.com for Insertion Loss, Return Loss, V.S.W.R. and other testing information.

2.92 mm and
2.40 mm terminations

APPLICATION

Copper foil
shielding

CABLE
TYPE

END 1
CONNECTOR

END 2
CONNECTOR

OVERALL
LENGTH

RF23C

= MWC-2350CU-01
Microwave Cable
with copper
foil shield

Specify
END OPTIONS
from chart

– “XXXX”
= Overall Length
in millimeters
–0152 (0152 mm)
5.984" minimum

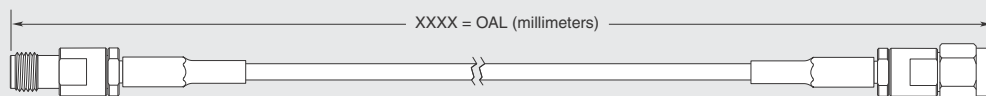

–92SJ–92SP SHOWN

–24SJ & –24SP
PRELIMINARY

OTHER SOLUTIONS

- Bulls Eye® Test Point available
See www.samtec.com?BE40C for complete specifications.

Notes:

Cable lengths longer than 40.00" (1 meter) are not supported with S.I. test data.

Some lengths, styles and options are non-standard, non-returnable.

END OPTIONS*

–92SJ = 2.92 mm Straight Jack
–24SJ = 2.40 mm Straight Jack
(30 μ" (0.76 μm) Gold on Center Contact,
Stainless Steel on Shell)

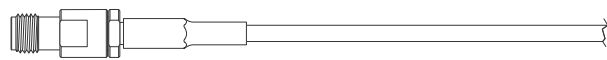

–92SP = 2.92 mm Straight Plug
–24SP = 2.40 mm Straight Plug
(30 μ" (0.76 μm) Gold on Center Contact,
Stainless Steel on Shell)

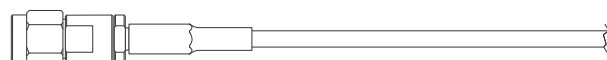

* 2.40 mm end option is needed for 50 GHz performance.
Contact RFTechnicalGroup@samtec.com

Due to technical progress, all designs, specifications and components are subject to change without notice.

WWW.SAMTEC.COM

All parts within this catalog are built to Samtec's specifications.

Customer specific requirements must be approved by Samtec and identified in a Samtec customer-specific drawing to apply.

50 Ω, 23 AWG SOLID, MICRO CU COAX CABLE

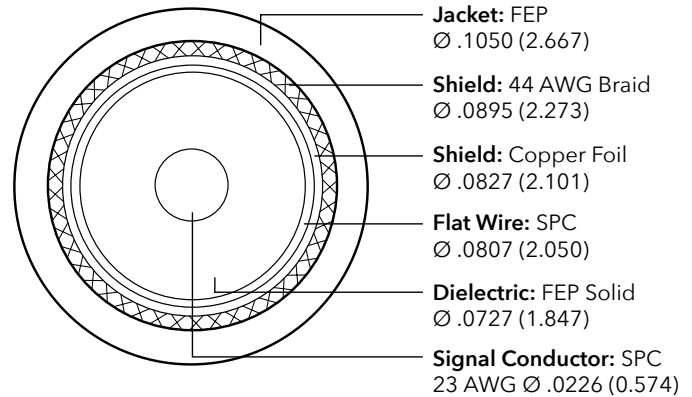
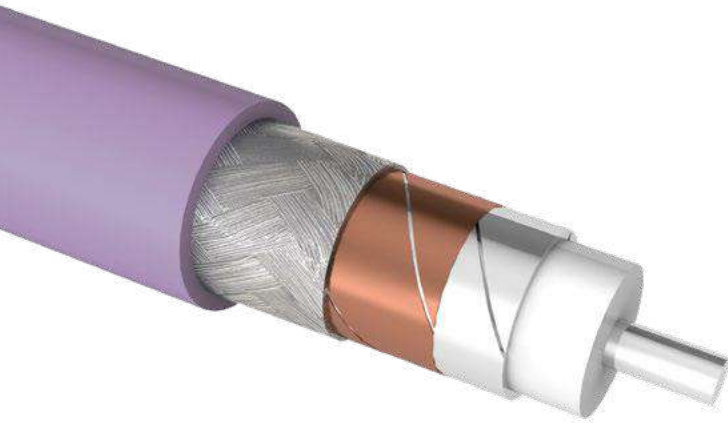

PERFORMANCE DATA

Capacitance: 97.80 pF/meter (nominal)
 Propagation Delay: 4.76 ns/meter
 Flex Cycles: 600 cycles, single conductor*
 Current Rating: Single conductor = 6.9 Amps**

Shield DCR: 10.8 Ω/1000 ft
 CC DCR: 21.6 Ω/1000 ft
 Min. Bend Radius: 6 mm
 Availability: Single
 Temperature Rating: -65 °C to +125 °C, UL VW-1 Tested ***
 DWV Working Voltage: 375 V†

| Insertion Loss | 0.25 m | 1 m |
|----------------|---------|---------|
| -3 dB | >40 GHz | 13 GHz |
| -7 dB | >40 GHz | >40 GHz |

* Test Conditions – 4 oz. weight, dia 7/8" mandrel, +/-90 bend X2

** Rating – 30 °C Temperature Rise, 20% de-rated.

*** Temperature Rating – Heat Shock/Cold Soak per UL #1581, wire wrap 1/4" mandrel, visual inspection

†Test Conditions – IR/DWW/Thermal Shock/Humidity per EIA-364-20, 21, 31 and 32

INSERTION LOSS AND RETURN LOSS GRAPHS‡

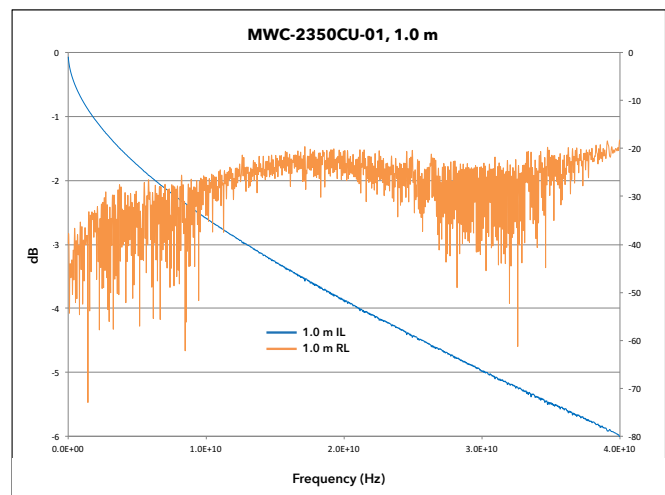
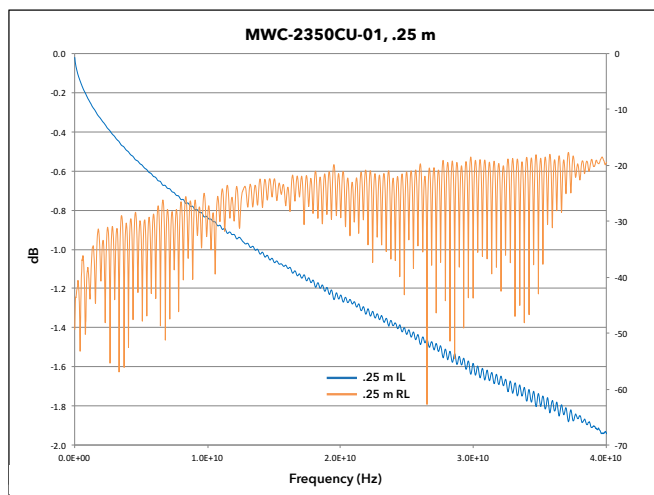

‡IL and RL data is typical. Results may vary. DUT terminated with SMA Connector and has not been de-embedded.



RF25S, RF23S SERIES

50 Ω RF CABLE ASSEMBLIES

Mates with:
SMA, SMP

SPECIFICATIONS

For complete specifications see www.samtec.com?RF25S

MWC-2550-01

Cable:
Type: Low Loss Microwave Coax
Gauge: 25 AWG
Shield Material:
1. Flat silver plated copper
2. Silver plated copper braid
Dielectric: Solid FEP
Jacket Material: FEP
Bend Radius: 9 mm
Impedance: 50 Ω ± 1 Ω
Propagation Delay: 4.76 nsec/meter
Capacitance: 96.8 pF/meter

Notes:
Cable lengths longer than 40.00" (1 meter) are not supported with S.I. test data.
Some lengths, styles and options are non-standard, non-returnable.

| CABLE TYPE | END 1 CONNECTOR | END 2 CONNECTOR | OVERALL LENGTH | | | | | | | | | | | | | | | | | | | | | | | | | | | | | | | | | | | | | | | | | | | |
|--|---|-----------------|--|--|--|--|--|--|---|-------------|--|---|--|---|--|---|--|---|---|--|--|--|---------|---|---|---|---------|-----|-----|-----|---------|-----|-----|-----|---------|-----|-----|-----|---------|-----|-----|-----|---------|-----|-----|-----|
| RF25S = MWC-2550-01 Microwave Cable with 25 AWG solid FEP Dielectric | Specify END OPTIONS from chart | | - "XXXX" = Overall Length in millimeters -0100 (100 mm) 3.94" minimum | | | | | | | | | | | | | | | | | | | | | | | | | | | | | | | | | | | | | | | | | | | |
| <table border="1"> <thead> <tr> <th colspan="2">END OPTIONS</th> </tr> </thead> <tbody> <tr> <td>-01SP1 = SMA Straight Plug (30 μ" (0.76 μm) Gold on Center Contact, Gold Flash on Shell)</td> <td></td> </tr> <tr> <td>-01BJ1 = SMA Bulkhead Jack (30 μ" (0.76 μm) Gold on Center Contact, Gold Flash on Shell)</td> <td></td> </tr> <tr> <td>-00SJ7 = SMP Straight Jack (10 μ" (0.25 μm) Gold on Center Contact, Gold Flash on Shell)</td> <td></td> </tr> </tbody> </table> | END OPTIONS | | -01SP1 = SMA Straight Plug (30 μ" (0.76 μm) Gold on Center Contact, Gold Flash on Shell) | | -01BJ1 = SMA Bulkhead Jack (30 μ" (0.76 μm) Gold on Center Contact, Gold Flash on Shell) | | -00SJ7 = SMP Straight Jack (10 μ" (0.25 μm) Gold on Center Contact, Gold Flash on Shell) | | <table border="1"> <thead> <tr> <th colspan="2">END OPTIONS</th> </tr> </thead> <tbody> <tr> <td>-00RJ7 = SMP Right-angle Jack (10 μ" (0.25 μm) Gold on Center Contact, Gold Flash on Shell)</td> <td></td> </tr> <tr> <td>-SING = Single Ended (End 2 only)</td> <td></td> </tr> <tr> <td>XXXXXX = Stripped & Tinned (End 2 only)</td> <td></td> </tr> </tbody> </table> | END OPTIONS | | -00RJ7 = SMP Right-angle Jack (10 μ" (0.25 μm) Gold on Center Contact, Gold Flash on Shell) | | -SING = Single Ended (End 2 only) | | XXXXXX = Stripped & Tinned (End 2 only) | | <table border="1"> <thead> <tr> <th colspan="4">STRIPPED & TINNED (Dimensions in mm)</th> </tr> <tr> <th>CALLOUT</th> <th>A</th> <th>B</th> <th>C</th> </tr> </thead> <tbody> <tr> <td>-303030</td> <td>3.0</td> <td>3.0</td> <td>3.0</td> </tr> <tr> <td>-303040</td> <td>3.0</td> <td>3.0</td> <td>4.0</td> </tr> <tr> <td>-403030</td> <td>4.0</td> <td>3.0</td> <td>3.0</td> </tr> <tr> <td>-403040</td> <td>4.0</td> <td>3.0</td> <td>4.0</td> </tr> <tr> <td>-404040</td> <td>4.0</td> <td>4.0</td> <td>4.0</td> </tr> </tbody> </table> <p>Both center conductor and braid shield are stripped, only the center conductor is tinned.</p> | STRIPPED & TINNED (Dimensions in mm) | | | | CALLOUT | A | B | C | -303030 | 3.0 | 3.0 | 3.0 | -303040 | 3.0 | 3.0 | 4.0 | -403030 | 4.0 | 3.0 | 3.0 | -403040 | 4.0 | 3.0 | 4.0 | -404040 | 4.0 | 4.0 | 4.0 |
| END OPTIONS | | | | | | | | | | | | | | | | | | | | | | | | | | | | | | | | | | | | | | | | | | | | | | |
| -01SP1 = SMA Straight Plug (30 μ" (0.76 μm) Gold on Center Contact, Gold Flash on Shell) | | | | | | | | | | | | | | | | | | | | | | | | | | | | | | | | | | | | | | | | | | | | | | |
| -01BJ1 = SMA Bulkhead Jack (30 μ" (0.76 μm) Gold on Center Contact, Gold Flash on Shell) | | | | | | | | | | | | | | | | | | | | | | | | | | | | | | | | | | | | | | | | | | | | | | |
| -00SJ7 = SMP Straight Jack (10 μ" (0.25 μm) Gold on Center Contact, Gold Flash on Shell) | | | | | | | | | | | | | | | | | | | | | | | | | | | | | | | | | | | | | | | | | | | | | | |
| END OPTIONS | | | | | | | | | | | | | | | | | | | | | | | | | | | | | | | | | | | | | | | | | | | | | | |
| -00RJ7 = SMP Right-angle Jack (10 μ" (0.25 μm) Gold on Center Contact, Gold Flash on Shell) | | | | | | | | | | | | | | | | | | | | | | | | | | | | | | | | | | | | | | | | | | | | | | |
| -SING = Single Ended (End 2 only) | | | | | | | | | | | | | | | | | | | | | | | | | | | | | | | | | | | | | | | | | | | | | | |
| XXXXXX = Stripped & Tinned (End 2 only) | | | | | | | | | | | | | | | | | | | | | | | | | | | | | | | | | | | | | | | | | | | | | | |
| STRIPPED & TINNED (Dimensions in mm) | | | | | | | | | | | | | | | | | | | | | | | | | | | | | | | | | | | | | | | | | | | | | | |
| CALLOUT | A | B | C | | | | | | | | | | | | | | | | | | | | | | | | | | | | | | | | | | | | | | | | | | | |
| -303030 | 3.0 | 3.0 | 3.0 | | | | | | | | | | | | | | | | | | | | | | | | | | | | | | | | | | | | | | | | | | | |
| -303040 | 3.0 | 3.0 | 4.0 | | | | | | | | | | | | | | | | | | | | | | | | | | | | | | | | | | | | | | | | | | | |
| -403030 | 4.0 | 3.0 | 3.0 | | | | | | | | | | | | | | | | | | | | | | | | | | | | | | | | | | | | | | | | | | | |
| -403040 | 4.0 | 3.0 | 4.0 | | | | | | | | | | | | | | | | | | | | | | | | | | | | | | | | | | | | | | | | | | | |
| -404040 | 4.0 | 4.0 | 4.0 | | | | | | | | | | | | | | | | | | | | | | | | | | | | | | | | | | | | | | | | | | | |
| ALSO AVAILABLE (MOQ Required) | Additional stripping and tinning options Contact Samtec. | | OTHER SOLUTIONS | | | | | | | | | | | | | | | | | | | | | | | | | | | | | | | | | | | | | | | | | | | |
| | | | Bulls Eye® test point available Contact Samtec. | | | | | | | | | | | | | | | | | | | | | | | | | | | | | | | | | | | | | | | | | | | |

SPECIFICATIONS

For complete specifications see www.samtec.com?RF23S

MWC-2350-01

Cable:
Type: Low Loss Microwave Coax
Gauge: 23 AWG
Shield Material:
1. Flat silver plated copper
2. Silver plated copper braid
Dielectric: Solid FEP
Jacket Material: FEP
Bend Radius: 12 mm
Impedance: 50 Ω ± 1 Ω
Propagation Delay: 4.72 nsec/meter
Capacitance: 95.45 pF/meter

Notes:
Cable lengths longer than 40.00" (1 meter) are not supported with S.I. test data.
Some lengths, styles and options are non-standard, non-returnable.

| CABLE TYPE | END 1 CONNECTOR | END 2 CONNECTOR | OVERALL LENGTH | | | | | | | | | | | | | | | | | | | | | | | | | | | | | | | | | | | | |
|--|--------------------------------|-----------------|--|--|--|--|--|--|---|--|---|---|--|--|--|---------|---|---|---|---------|-----|-----|-----|---------|-----|-----|-----|---------|-----|-----|-----|---------|-----|-----|-----|---------|-----|-----|-----|
| RF23S = MWC-2350-01 Microwave Cable with 23 AWG solid FEP Dielectric | Specify END OPTIONS from chart | | - "XXXX" = Overall Length in millimeters -0100 (100 mm) 3.94" minimum | | | | | | | | | | | | | | | | | | | | | | | | | | | | | | | | | | | | |
| <table border="1"> <thead> <tr> <th colspan="2">END OPTIONS</th> </tr> </thead> <tbody> <tr> <td>-35SJP = 3.50 mm Straight Jack (30 μ" (0.76 μm) Gold on Center Contact, Stainless Steel on Shell)</td> <td></td> </tr> <tr> <td>-35SPP = 3.50 mm Straight Plug (30 μ" (0.76 μm) Gold on Center Contact, Stainless Steel on Shell)</td> <td></td> </tr> <tr> <td>SING = Single Ended (End 2 only)</td> <td></td> </tr> <tr> <td>XXXXXX = Stripped & Tinned (End 2 only)</td> <td></td> </tr> </tbody> </table> | END OPTIONS | | -35SJP = 3.50 mm Straight Jack (30 μ" (0.76 μm) Gold on Center Contact, Stainless Steel on Shell) | | -35SPP = 3.50 mm Straight Plug (30 μ" (0.76 μm) Gold on Center Contact, Stainless Steel on Shell) | | SING = Single Ended (End 2 only) | | XXXXXX = Stripped & Tinned (End 2 only) | | <table border="1"> <thead> <tr> <th colspan="4">STRIPPED & TINNED (Dimensions in mm)</th> </tr> <tr> <th>CALLOUT</th> <th>A</th> <th>B</th> <th>C</th> </tr> </thead> <tbody> <tr> <td>-303030</td> <td>3.0</td> <td>3.0</td> <td>3.0</td> </tr> <tr> <td>-303040</td> <td>3.0</td> <td>3.0</td> <td>4.0</td> </tr> <tr> <td>-403030</td> <td>4.0</td> <td>3.0</td> <td>3.0</td> </tr> <tr> <td>-403040</td> <td>4.0</td> <td>3.0</td> <td>4.0</td> </tr> <tr> <td>-404040</td> <td>4.0</td> <td>4.0</td> <td>4.0</td> </tr> </tbody> </table> <p>Both center conductor and braid shield are stripped, only the center conductor is tinned.</p> | STRIPPED & TINNED (Dimensions in mm) | | | | CALLOUT | A | B | C | -303030 | 3.0 | 3.0 | 3.0 | -303040 | 3.0 | 3.0 | 4.0 | -403030 | 4.0 | 3.0 | 3.0 | -403040 | 4.0 | 3.0 | 4.0 | -404040 | 4.0 | 4.0 | 4.0 |
| END OPTIONS | | | | | | | | | | | | | | | | | | | | | | | | | | | | | | | | | | | | | | | |
| -35SJP = 3.50 mm Straight Jack (30 μ" (0.76 μm) Gold on Center Contact, Stainless Steel on Shell) | | | | | | | | | | | | | | | | | | | | | | | | | | | | | | | | | | | | | | | |
| -35SPP = 3.50 mm Straight Plug (30 μ" (0.76 μm) Gold on Center Contact, Stainless Steel on Shell) | | | | | | | | | | | | | | | | | | | | | | | | | | | | | | | | | | | | | | | |
| SING = Single Ended (End 2 only) | | | | | | | | | | | | | | | | | | | | | | | | | | | | | | | | | | | | | | | |
| XXXXXX = Stripped & Tinned (End 2 only) | | | | | | | | | | | | | | | | | | | | | | | | | | | | | | | | | | | | | | | |
| STRIPPED & TINNED (Dimensions in mm) | | | | | | | | | | | | | | | | | | | | | | | | | | | | | | | | | | | | | | | |
| CALLOUT | A | B | C | | | | | | | | | | | | | | | | | | | | | | | | | | | | | | | | | | | | |
| -303030 | 3.0 | 3.0 | 3.0 | | | | | | | | | | | | | | | | | | | | | | | | | | | | | | | | | | | | |
| -303040 | 3.0 | 3.0 | 4.0 | | | | | | | | | | | | | | | | | | | | | | | | | | | | | | | | | | | | |
| -403030 | 4.0 | 3.0 | 3.0 | | | | | | | | | | | | | | | | | | | | | | | | | | | | | | | | | | | | |
| -403040 | 4.0 | 3.0 | 4.0 | | | | | | | | | | | | | | | | | | | | | | | | | | | | | | | | | | | | |
| -404040 | 4.0 | 4.0 | 4.0 | | | | | | | | | | | | | | | | | | | | | | | | | | | | | | | | | | | | |

Due to technical progress, all designs, specifications and components are subject to change without notice.



RFA6T-74SP3-74SP3-0300

RFA6T, RFB6T SERIES

75 Ω OPTIMIZED BNC CABLE ASSEMBLIES

SPECIFICATIONS

For complete specifications see www.samtec.com?RFA6T or www.samtec.com?RFB6T

RF Connector:

Outer Contact Material:
Ni plated Brass (BNC),
Au plated BeCu (DIN),
Au plated Phosphor Bronze (HDBNC)

Center Contact Material:
Gold plated Brass

Insulator Material:
PTFE

Operating Temperature:
-65 °C to +125 °C

Impedance:
75 Ω ± 3 Ω (-ST)
75 Ω ± 4 Ω (-RA)

Frequency Range:
0-3.5 GHz *

Working Voltage:
500 Vrms max *

Dielectric Withstanding:
1500 Vrms min*

RoHS Compliant:
Yes

RG 6/1694A Cable:

Impedance:
75 Ω ± 3 Ω

Capacitance:
54 ± 3 pF/meter

Max Attenuation (cable only):
0.21 dB @ 1 GHz for 1 meter

Conductor Size:
18 AWG, (1.02 mm) .040" dia.

Conductor Material:
Bare Copper

Insulator Material:
Gas Injected Foamed Polyethylene

Shield Material:
Tinned Copper Braid over Aluminum Foil Wrap

Jacket Material:
PVC

Jacket Diameter:
(7.00 mm) .275"

Bend Radius: 69.85 mm

Jacket Color: Black

RoHS Compliant: Yes

Mates with:
BNC7T, DIN7A, HDBNC

18 AWG 75 Ω
RG 6 coax cable,
or 1694A Belden cable



Solutionator
DESIGN IN A MINUTE

- Create a full system: cable assembly and board level mates, 50 Ω and 75 Ω solutions
- 24-hour samples on standard products
- Visit: rf.samtec.com

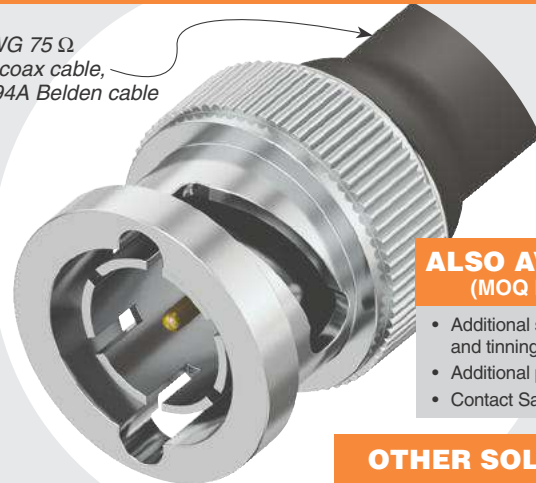

ALSO AVAILABLE (MOQ Required)

- Additional stripping and tinning options
- Additional plating options
- Contact Samtec.

OTHER SOLUTIONS

- Hand tool available. Contact RFGroup@samtec.com
- Cable connector kits (see cable components catalog pages)

* See connector component pages for specific range.

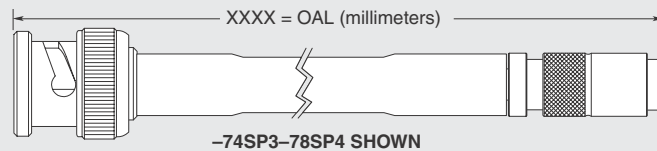
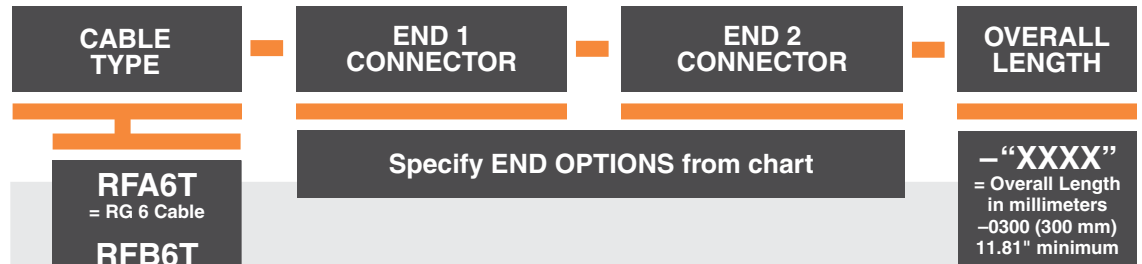

STRIPPED & TINNED (Dimensions in mm)

| CALLOUT | A | B | C |
|---------|-----|-----|-----|
| -303030 | 3.0 | 3.0 | 3.0 |
| -303040 | 3.0 | 3.0 | 4.0 |
| -403030 | 4.0 | 3.0 | 3.0 |
| -403040 | 4.0 | 3.0 | 4.0 |
| -404040 | 4.0 | 4.0 | 4.0 |

Both center conductor and braid shield are stripped, only the center conductor is tinned.

| END OPTIONS | | END OPTIONS | |
|--|--|--|--|
| -H4SP3 = 75 Ω High-Density BNC Straight Plug (10 μ" (0.25 μm) Gold on Center Contact, Nickel on Shell) | | -74RP3 = 75 Ω BNC Right-angle Plug (10 μ" (0.25 μm) Gold on Center Contact, Nickel on Shell) | |
| -78SP4 = 75 Ω DIN Straight Plug (10 μ" (0.25 μm) Gold on Center Contact, Nickel on Shell) | | -SING = Single Ended (End 2 callout) | |
| -74SP3* = 75 Ω BNC Straight Plug (10 μ" (0.25 μm) Gold on Center Contact, Nickel on Shell) | | -XXXXXX = Stripped & Tinned (End 2 callout) (See chart for callout) | |

(*Die Cast also available = -D4SP3)

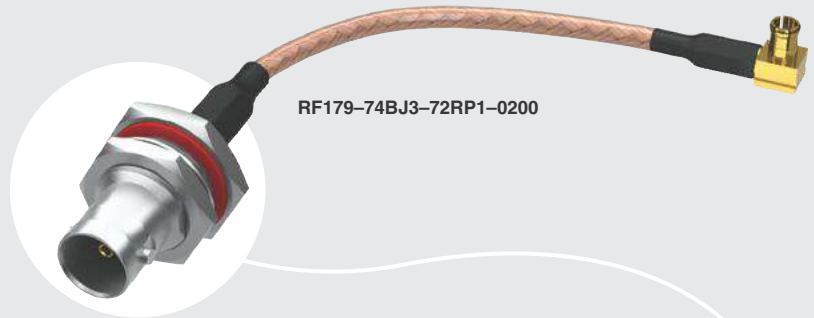

RF179-74BJ3-72RP1-0200

75 Ω OPTIMIZED RG 179 CABLES

SPECIFICATIONS

For complete specifications see www.samtec.com?RF179

RF Connector:

Outer Contact Material:

Ni plated Brass

(BNC)

Au plated Brass

(SMB)

Au plated BeCu

(MCX, MMCX7, DIN)

Center Contact Material:

Au plated Brass

(BNC-P, MCX, MMCX7)

Au plated BeCu

(SMB)

Au plated Copper Alloy

(DIN, BNC-J)

Insulator Material:

PTFE

Operating Temperature:

-50 °C to +165 °C

Impedance:

75 Ω

Frequency Range:

0-4 GHz *

(Cable & connector dependent)

RoHS Compliant:

Yes

RG 179 Cable:

Impedance:

75 Ω ±3 Ω

Capacitance:

64 pF/meter

Propagation Delay:

4.83 nsec/meter

Max Attenuation

(cable only):

0.8 dB @ 1 GHz for 1 meter

Conductor Size:

30 AWG, (0.31 mm) .012" dia.

Conductor Material:

Silver Plated Copper

Conductor Resistance:

0.34 Ω/meter max

Current Rating:

3 A DC

Insulator Diameter:

(1.6 mm) .063"

Insulator Material:

PTFE

Dielectric Constant:

1.8 dK

Shield Material:

Silver Plated Copper

Jacket Material:

FEP

Jacket Diameter:

(2.54 mm) .100"

Bend Radius:

10.2 mm

Jacket Temp Rating:

-50 °C to +165 °C

Jacket Color:

Amber

RoHS Compliant:

Yes

Mates with:

BNC7T, MCX7, MMCX7,
SMB7H, DIN7A



Solutionator
DESIGN IN A MINUTE

- Create a full system: cable assembly and board level mates, 50 Ω and 75 Ω solutions
- 24-hour samples on standard products
- Visit: rf.samtec.com

* See connector component pages for specific range.

30 AWG
75 Ω RG 179
coax cable

Standard
Heat Shrink

Single or Double
Ended

CABLE TYPE

END 1
CONNECTOR

END 2
CONNECTOR

RF179
= RG 179 Cable

Specify END OPTIONS from chart

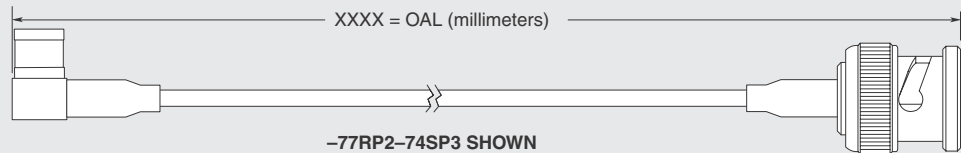

| END OPTIONS | | END OPTIONS | |
|--|--|--|--|
| <p>-73SP4 = 75 Ω MMCX7 Straight Plug (10 μ" (0.25 μm) Gold on Center Contact, Gold Flash on Shell)</p> | | <p>-72RP1 = 75 Ω MCX Right-angle Plug (30 μ" (0.76 μm) Gold on Center Contact, Gold Flash on Shell)</p> | |
| <p>-73RP1 = 75 Ω MMCX7 Right-angle Plug (30 μ" (0.76 μm) Gold on Center Contact, Gold Flash on Shell)</p> | | <p>-72SP1 = 75 Ω MCX Straight Plug (30 μ" (0.76 μm) Gold on Center Contact, Gold Flash on Shell)</p> | |
| <p>-73SJ4 = 75 Ω MMCX7 Straight Jack (10 μ" (0.25 μm) Gold on Center Contact, Gold Flash on Shell)</p> | | <p>-77SP1 = 75 Ω SMB Straight Plug (30 μ" (0.76 μm) Gold on Center Contact, Gold Flash on Shell)</p> | |

Due to technical progress, all designs, specifications and components are subject to change without notice.

WWW.SAMTEC.COM

All parts within this catalog are built to Samtec's specifications.

Customer specific requirements must be approved by Samtec and identified in a Samtec customer-specific drawing to apply.

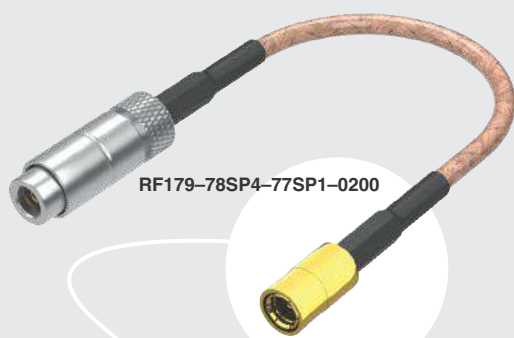

RF179-78SP4-77SP1-0200



RF179-72SP1-73SJ4-0100

RF179 SERIES



Wide variety of 75 Ω end options including BNC, MCX and SMB

Straight or Right-angle terminations



ALSO AVAILABLE
(MOQ Required)

- Additional stripping and tinning options
 - Additional plating options
 - Additional end connector combinations
- Contact Samtec.

OTHER SOLUTIONS

- Cable connector kits (see cable components catalog pages)

OVERALL LENGTH

—“XXXX”

= Overall Length in millimeters -0100 (100 mm) 3.94" minimum

STRIPPED & TINNED
(Dimensions in mm)



| CALLOUT | A | B | C |
|---------|-----|-----|-----|
| -303030 | 3.0 | 3.0 | 3.0 |
| -303040 | 3.0 | 3.0 | 4.0 |
| -403030 | 4.0 | 3.0 | 3.0 |
| -403040 | 4.0 | 3.0 | 4.0 |
| -404040 | 4.0 | 4.0 | 4.0 |

Both center conductor and braid shield are stripped, only the center conductor is tinned.

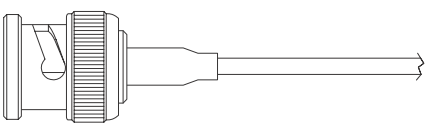
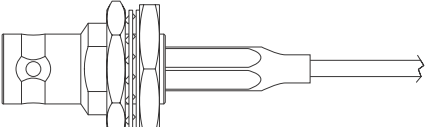
END OPTIONS

| |
|---|
| <p>-77RP1 = 75 Ω SMB Right-angle Plug (30 μ" (0.76 μm) Gold on Center Contact, Gold Flash on Shell)</p>  |
| <p>-74SP3 = 75 Ω BNC Straight Plug -D4SP3 = 75 Ω BNC Die Cast Straight Plug (10 μ" (0.25 μm) Gold on Center Contact, Nickel on Shell)</p>  |
| <p>-74BJ3 = 75 Ω BNC Bulkhead Jack (10 μ" (0.25 μm) Gold on Center Contact, Nickel on Shell)</p>  |

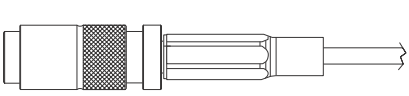
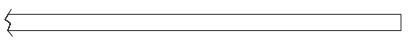
END OPTIONS

| |
|--|
| <p>-78SP4 = 75 Ω DIN Straight Plug (10 μ" (0.25 μm) Gold on Center Contact, Nickel on Shell)</p>  |
| <p>-SING = Single Ended (End 2 callout)</p>  |
| <p>XXXXXX = Stripped & Tinned (End 2 callout)</p>  |

Due to technical progress, all designs, specifications and components are subject to change without notice.

WWW.SAMTEC.COM

All parts within this catalog are built to Samtec's specifications.
Customer specific requirements must be approved by Samtec and identified in a Samtec customer-specific drawing to apply.



RFB8T SERIES

75 Ω OPTIMIZED 1855A CABLE ASSEMBLIES

SPECIFICATIONS

For complete specifications see www.samtec.com?RFB8T

RF Connector:

Outer Contact Material:

Ni plated Brass (BNC)

Au plated BeCu (DIN)

Center Contact Material:

Au plated Brass

Operating Temperature:

-65 °C to +125 °C

Impedance:

75 Ω ±2 Ω (ST), 75 Ω ±4 Ω (RA)

Frequency Range:

0-3.5 GHz *

Working Voltage:

250 Vrms (DIN),

330 Vrms (BNC)

Dielectric Withstanding:

750 Vrms (DIN),

1000 Vrms (BNC)

RoHS Compliant:

Yes

1855A Cable:

Impedance:

75 Ω ±3 Ω

Capacitance:

56 ±3 pF/meter

Max Attenuation

(cable only):

0.37 dB @ 1 GHz for 1 meter

Conductor Size:

23 AWG, (0.58 mm) .023" dia.

Conductor Material:

Bare Copper

Insulator Material:

Gas Injected Foamed

Polyethylene

Shield Material:

Tin Copper

Jacket Material:

PVC

Jacket Diameter:

(4.03 mm) .159"

Bend Radius:

38.1 mm

Jacket Color:

Black

RoHS Compliant:

Yes

Mates with:

DIN7A, HDBNC



Solutionator
DESIGN IN A MINUTE

- Create a full system: cable assembly and board level mates, 50 Ω and 75 Ω solutions
- 24-hour samples on standard products
- Visit: rf.samtec.com

23 AWG 75 Ω
1855A Belden cable



Single or Double Ended

* See connector component pages for specific range.

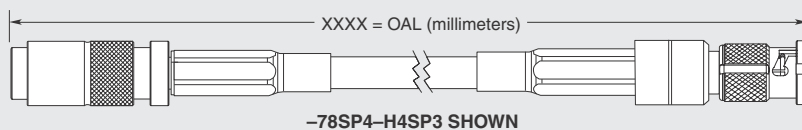
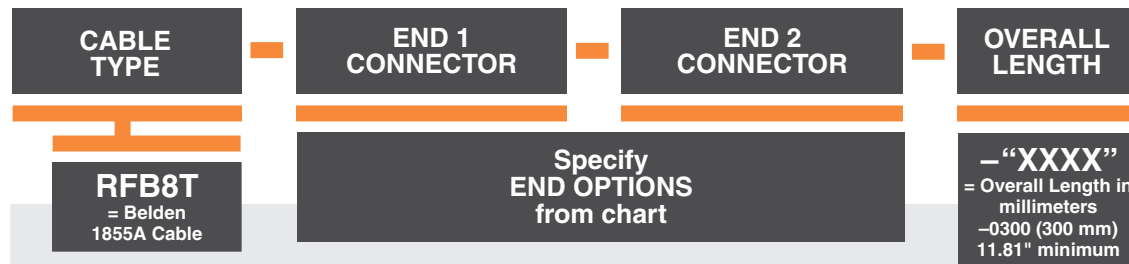

ALSO AVAILABLE (MOQ Required)

- Additional stripping and tinning options
 - Additional plating options
- Contact Samtec.

OTHER SOLUTIONS

- Hand tool available. Contact RFGroup@samtec.com
- Cable connector kits (see cable components catalog pages)

STRIPPED & TINNED (Dimensions in mm)

| CALLOUT | A | B | C |
|---------|-----|-----|-----|
| -303030 | 3.0 | 3.0 | 3.0 |
| -303040 | 3.0 | 3.0 | 4.0 |
| -403030 | 4.0 | 3.0 | 3.0 |
| -403040 | 4.0 | 3.0 | 4.0 |
| -404040 | 4.0 | 4.0 | 4.0 |

Both center conductor and braid shield are stripped, only the center conductor is tinned.

| END OPTIONS | |
|---|--|
| -H4SP3 = 75 Ω High-Density BNC Straight Plug (10 μ" (0.25 μm) Gold on Center Contact, Nickel on Shell) | |
| -78SP4 = 75 Ω DIN Straight Plug (10 μ" (0.25 μm) Gold on Center Contact, Nickel on Shell) | |

| END OPTIONS | |
|--|--|
| -SING = Single Ended (End 2 callout) | |
| -XXXXXX = Stripped & Tinned (End 2 callout) (See chart for callout) | |

Due to technical progress, all designs, specifications and components are subject to change without notice.

WWW.SAMTEC.COM

All parts within this catalog are built to Samtec's specifications.

Customer specific requirements must be approved by Samtec and identified in a Samtec customer-specific drawing to apply.



50 Ω & 75 Ω CONNECTORS

50 Ω CONNECTORS

| | |
|---|-------|
| 2.92 mm Precision Jacks & Cable Components (292, 292-CA)..... | 42-43 |
| 50 Ω SMA Jacks & Cable Components (SMA, SMA-CA) | 44-46 |
| 50 Ω SMP Jacks/Plugs & Adaptor (SMP, SMP-CA) | 47 |
| 50 Ω SMB Jacks & Plugs (SMB5, SMB5-CA)..... | 48 |
| 50 Ω MMCX & MCX Jacks & Plugs (MMCX, MCX) | 49-50 |
| 50 Ω MMCX & MCX Cable Components (MMCX-CA, MCX-CA) | 51 |
| 50 Ω BNC Cable Components (BNC5-CA) | 52 |
| 50 Ω N Type Cable Components (NTPE-CA) | 53 |
| 50 Ω TNC Jacks & Cable Components (TNC, TNC-CA) | 54 |

75 Ω CONNECTORS

| | |
|---|-------|
| 75 Ω DIN 1.0/2.3 Jacks & Cable Components (DIN7A, DIN7A-CA)..... | 55 |
| 75 Ω High Density BNC Jacks & Cable Components (HDBNC, HDBNC-CA) | 56-57 |
| 75 Ω BNC Jacks & Cable Components (BNC7T, BNC7T-CA) | 58-59 |
| 75 Ω SMB Jacks & Cable Components (SMB7H, SMB7H-CA)..... | 60 |

APPLICATIONS

| | |
|--------------------------------------|-------|
| 50 Ω Cables & Connectors..... | 8-9 |
| 75 Ω Cables & Connectors..... | 10-11 |



292-J-P-HP-ST-CM2



292-CM SERIES

50 Ω 2.92 JACK

SPECIFICATIONS

For complete specifications and assembly instructions see www.samtec.com?292-CM

- Shell Material:** Stainless Steel
- Insert:** Stainless Steel
- Socket:** BeCu
- Insulator Material:** PCTFE
- Impedance:** 50 Ω
- RoHS Compliant:** Yes
- Lead-Free Solderable:** Yes

APPLICATION



Performance up to 40 GHz/80 Gbps

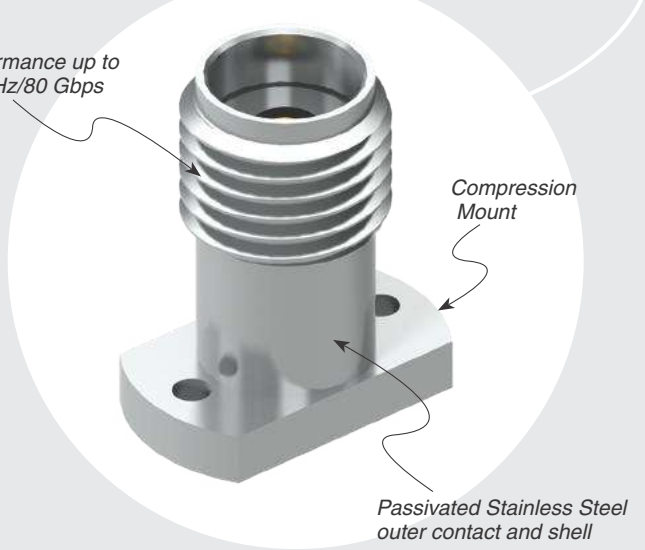

| TYPE | GENDER | TYPE | PLATING | ORIENTATION | TERMINATION |
|--|---------------------|--------------------------|---|--------------------------|------------------------------------|
| 292 = Passivated Stainless Steel | -J = Jack | -P = PCB Mount | -HP = 30 μ" (0.76 μm) Gold center contact, Passivated outer contact | -ST = Straight | -CM2 = Compression Mount |

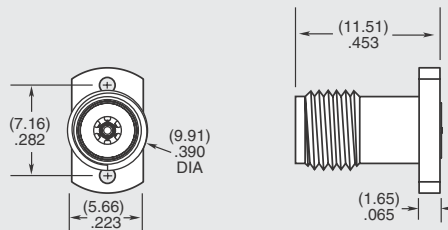

Due to technical progress, all designs, specifications and components are subject to change without notice.

292-J-C-HP-ST-CS3



292-P-C-HP-ST-CS3

292-CA SERIES

50 Ω 2.92 COMPONENTS

SPECIFICATIONS

For complete specifications and assembly instructions see www.samtec.com?292-CA

- Shell Material:** Stainless Steel
- Contact Material:** BeCu
- Cable Body:** Stainless Steel
- Insulator Material:** Ultem 1000
- Insert Material:** Stainless Steel

| TYPE | GENDER | TYPE | PLATING | ORIENTATION | TERMINATION |
|--|---------------------|----------------------|---|--------------------------|--|
| 292 = Passivated Stainless Steel | -J = Jack | -C = Cable | -HP = 30 μ" (0.76 μm) Gold center contact, Passivated outer contact | -ST = Straight | -CS3 = MWC-2350-01 23 AWG Microwave Cable |

SPECIFICATIONS

For complete specifications and assembly instructions see www.samtec.com?292-CA

- Shell Material:** Stainless Steel
- Contact Material:** BeCu
- Cable Body:** Stainless Steel
- Insulator Material:** Ultem 1000
- Gasket:** Silicone
- C-Ring:** Stainless Steel

| TYPE | GENDER | TYPE | PLATING | ORIENTATION | TERMINATION |
|--|---------------------|----------------------|---|--------------------------|--|
| 292 = Passivated Stainless Steel | -P = Plug | -C = Cable | -HP = 30 μ" (0.76 μm) Gold center contact, Passivated outer contact | -ST = Straight | -CS3 = MWC-2350-01 23 AWG Microwave Cable |

Due to technical progress, all designs, specifications and components are subject to change without notice.

WWW.SAMTEC.COM

All parts within this catalog are built to Samtec's specifications.
Customer specific requirements must be approved by Samtec and identified in a Samtec customer-specific drawing to apply.



SMA-J-P-H-ST-TH1

SMA-J-P-H-RA-TH1

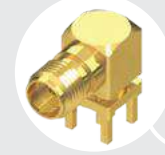

SMA-J-P-H-ST-EM1

50 Ω SMA JACKS

SPECIFICATIONS

For complete specifications and recommended PCB layouts see www.samtec.com?SMA-TH, www.samtec.com?SMA-SM, www.samtec.com?SMA-EM or www.samtec.com?SMA-MT

- Contact Material:** BeCu
- Shell Material:** Brass
- Insulator Material:** PTFE (-PN)
- Operating Temp Range:** -65 °C to +125 °C
- Impedance:** 50 Ω
- Dielectric Withstanding Voltage:** 1,000 Vrms
- Frequency Range:** 0~20 GHz (Cable dependent)
- Working Voltage:** 335 V
- RoHS Compliant:** Yes

Mates with:
 RF174, RF316, RF058,
 RF405, RF402, RS316,
 GRF1H-C, IJ5H, RF23S

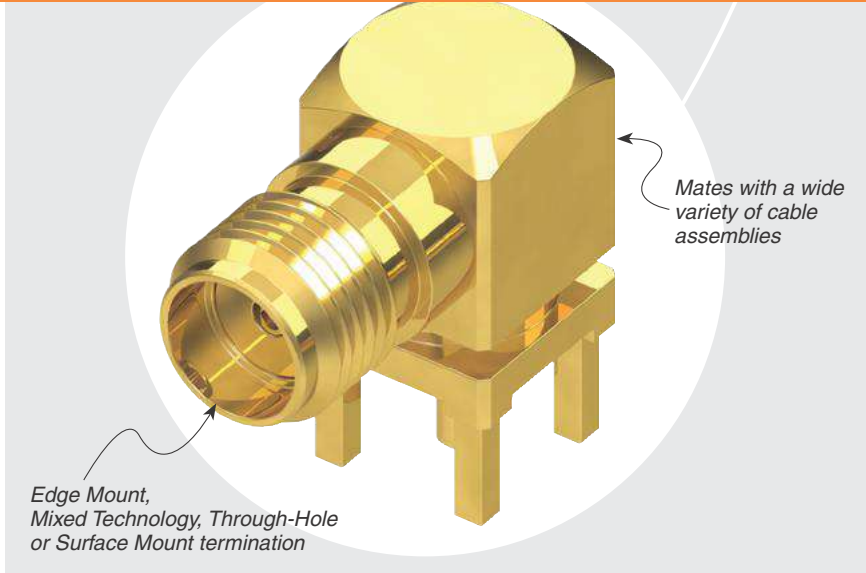

PROCESSING

Lead-Free Solderable: Yes

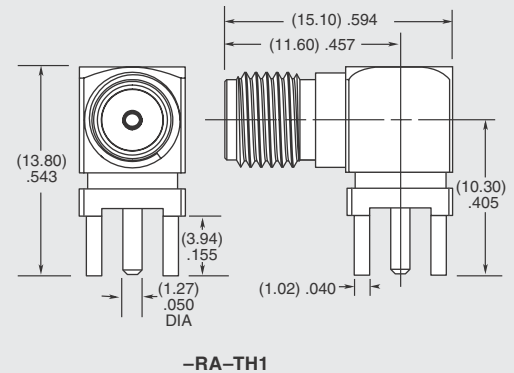
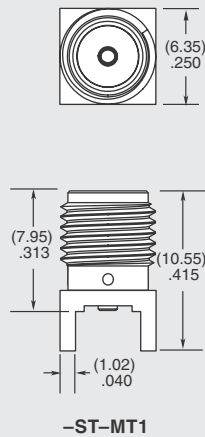
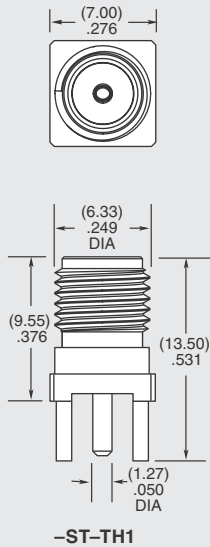
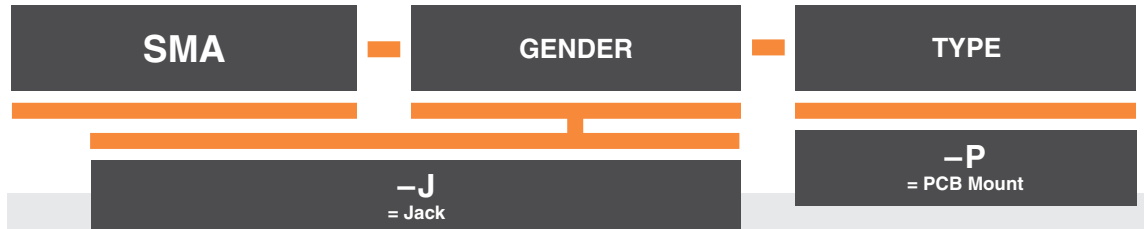

Note: While optimized for 50 Ω applications, this connector can also perform well in certain 75 Ω applications. Contact RFGroup@samtec.com for further information.

Due to technical progress, all designs, specifications and components are subject to change without notice.

WWW.SAMTEC.COM

All parts within this catalog are built to Samtec's specifications. Customer specific requirements must be approved by Samtec and identified in a Samtec customer-specific drawing to apply.

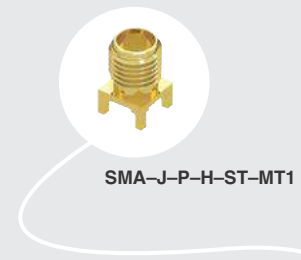
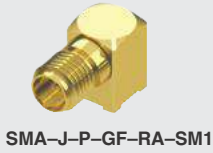

SMA SERIES

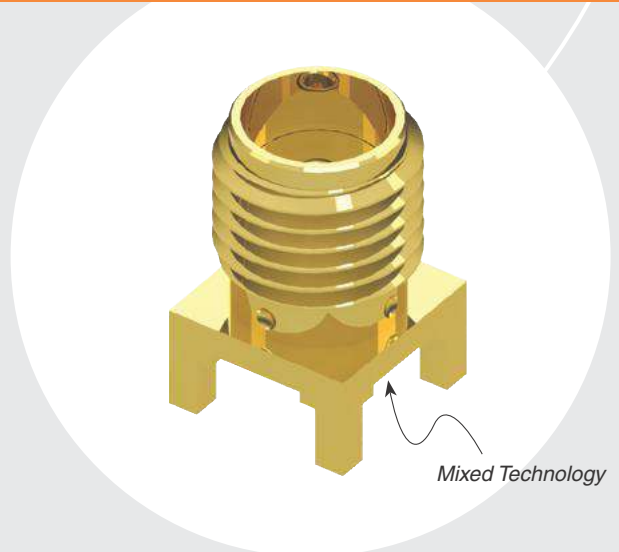
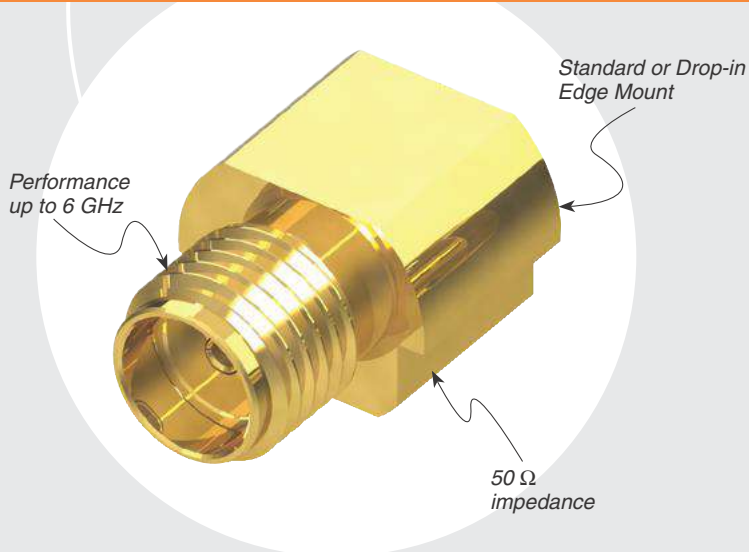

PLATING

-H

= 30 μ" (0.76 μm) Gold center contact,
3 μ" (0.08 μm) Gold outer contact

-GF

= 10 μ" (0.25 μm) Gold center contact,
3 μ" (0.08 μm) Gold outer contact
(-SM1 only)

ORIENTATION

-ST

= Straight

-RA

= Right-angle

TERMINATION

-TH1

= Through-hole

-SM1

= Surface Mount
(-GF-RA only)

-EM1

= Edge Mount
(-ST only)

-EM3

= Drop-in Edge Mount
(-ST only)

-MT1

= Mixed Technology
(-ST only)

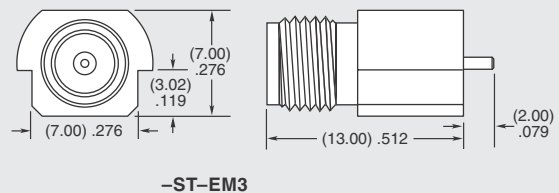
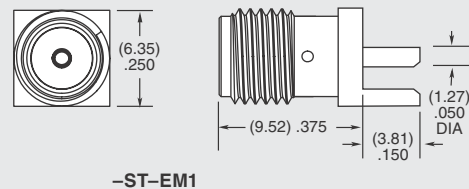
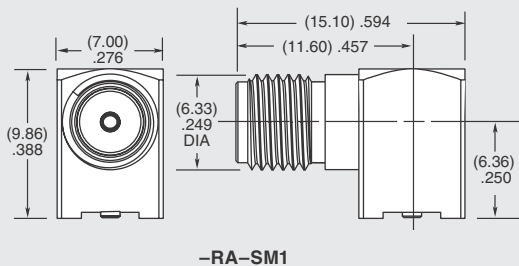

Due to technical progress, all designs, specifications and components are subject to change without notice.

WWW.SAMTEC.COM

All parts within this catalog are built to Samtec's specifications.
Customer specific requirements must be approved by Samtec and identified in a Samtec customer-specific drawing to apply.

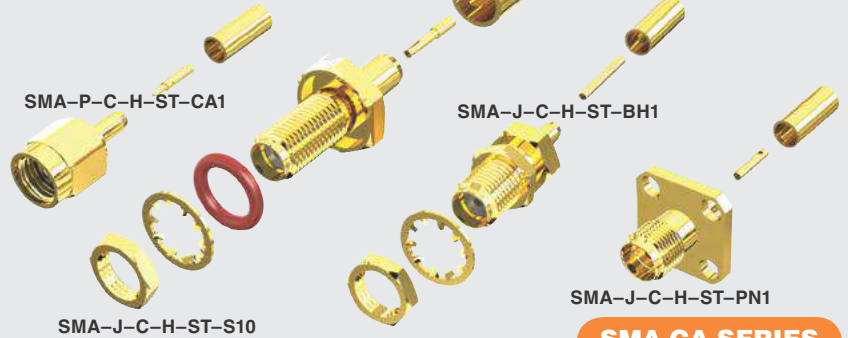
SMA-CA SERIES

50 Ω SMA COMPONENTS

SPECIFICATIONS

For complete specifications and assembly instructions see www.samtec.com?SMA-CA

Shell Material:

Brass

Contact Material:

Brass

Center Contact:

Soldered

Outer Ferrule:

Crimped

Operating Temperature:

-65 °C to +125 °C

Voltage Rating:

335 V

Dielectric Withstanding Voltage:

1,000 Vrms

Frequency Range:

0-20 GHz
(Cable dependent)

Impedance:

50 Ω

| SMA | GENDER | TYPE | PLATING | ORIENTATION | TERMINATION |
|-----|---------------------|--|--|--------------------------|--|
| | -J = Jack | -C = Cable -C4 = Cable 4-Mounting Screws (-PN1 only) | -H = 30 μ" (0.76 μm) Gold center contact, 3 μ" (0.08 μm) Gold outer contact (N/A with -BH1S) -HF = 30 μ" (0.76 μm) Gold center contact, 3 μ" (0.08 μm) Gold outer contact (-BH1S only) | -ST = Straight | -BH1 = Bulkhead RG 174 / 316 Cable -BH2 = Bulkhead RG 178 Cable -BR1 = Bulkhead RG 174 / 316, Reversed Polarity -BR2 = Bulkhead RG 178 Cable, Reversed Polarity -BH1S = Bulkhead RG 316 Cable, Double Shield -B10 = Bulkhead RG 58 Cable -PN1 = 4-Hole Panel Mount RG 174 / 316 Cable -S10 = Sealed Bulkhead RG 58 Cable |
| | | | | | |
| | | -BH1, -BH2, -BR1, -BR2, BH1S | | | -S10, -B10 |

Supplied with pins, washers, nuts and ferrules. See website for dimensions.

| SMA | GENDER | TYPE | PLATING | ORIENTATION | TERMINATION |
|-----|---------------------|----------------------|---|---|--|
| | -P = Plug | -C = Cable | -H = 30 μ" (0.76 μm) Gold center contact, 3 μ" (0.08 μm) Gold outer contact (-CA1, -CA10 only) -HF = 30 μ" (0.76 μm) Gold center contact, 3 μ" (0.08 μm) Gold outer contact (-CA7, -CA9, -CA1S only) | -ST = Straight -RA = Right-angle | -CA1 = RG 174 / 316 Cable -CA7 = RG 405 (.086" DIA) Semi-flexible Cable -CA9 = RG 402 (.141" DIA) Semi-flexible Cable -C10 = RG 58 Cable (-ST only) -CA1S = RG 316 Double Shielded Cable (-ST only) |
| | | | | | |
| | | | | | -ST-CA9 & -ST-C10 |

Supplied with pins and ferrules. See website for dimensions.

Due to technical progress, all designs, specifications and components are subject to change without notice.

WWW.SAMTEC.COM

All parts within this catalog are built to Samtec's specifications.

Customer specific requirements must be approved by Samtec and identified in a Samtec customer-specific drawing to apply.

SMP-J-B-GF-ST-1450



SMP-J-C-GF-ST-CA5



SMP-PF-P-HH-ST-EM3



SMP-PF-P-GF-ST-TH2



SMP-J-C-GF-RA-CA7

SMP SERIES

50 Ω SMP JACKS/PLUGS & ADAPTOR

SMP-PF, SMP-PL, SMP-PS, SMP-PC
Mate with:
SMP-B Bullet Adaptor

Cable Mates:
RF405, RF25S

SPECIFICATIONS

For complete specifications see www.samtec.com?SMP-TH, www.samtec.com?SMP-EM, www.samtec.com?SMP-B or www.samtec.com?SMP-CA

Shell Material:
Au plated Brass (-TH2, -EM3)
Au plated BeCu (-J-B, -J-C)

Contact Material:
Brass (-TH2, -EM3)
BeCu (-CA)

Insulator Material:
PTFE

Impedance:
50 Ω

Frequency Range:
DC to 40 GHz,
DC to 20 GHz (25 AWG)

Working Voltage:
335 Vrms min

Dielectric Withstanding:
500 Vrms min

Engagement Force:
-PF: 15 lbs. max
-PL: 10 lbs. max
-PS & -PC: 2 lbs. max

Disengagement Force:
-PF: 2 lbs. min
-PL: 2 lbs. min
-PS & -PC: 0.5 lbs. min

Operating Temperature:
-65 °C to +165 °C

RoHS Compliant:
Yes

PROCESSING

Lead-Free Solderable:
Yes

ALTERNATIVE SOLUTIONS

The SMP Series is an alternative to the Corning Gilbert GPO Series. A mini SMP Series, available as an ASO, is an alternative to the Corning Gilbert GPPO Series.

Note:
While optimized for 50 Ω applications, this connector can also perform well in certain 75 Ω applications. Contact RFGroup@samtec.com for further information.

| SMP | GENDER | TYPE | PLATING | ORIENTATION | TERMINATION |
|-----|--------|-------------------------------|--|-------------------|---|
| | | -P = PCB Mount | -GF = 10 μ" (0.25 μm) Gold center contact, Gold Flash outer contact (-TH2 only) | -ST = Straight | -TH2 = Through-hole |
| | | -PF = Plug, Full Detent | -HH = 30 μ" (0.76 μm) Gold center and outer contact (-EM3) | | -EM3 = Drop-in Edge Mount (Not available with -PC) |
| | | -PL = Plug, Limited Detent | | | |
| | | -PS = Plug, Smooth Bore | | | |
| | | -PC = Plug, Catcher's Mitt | | | |

| GENDER | A DIA |
|--------|-------------|
| -PF | (4.19) .165 |
| -PL | (4.19) .165 |
| -PS | (4.19) .165 |
| -PC | (5.99) .236 |

APPLICATION

| LENGTH | BOARD SPACE |
|--------|--------------|
| -0645 | (9.05) .356 |
| -1450 | (17.10) .673 |

EXTRACTION TOOL

- CAT-EX-SMP-01 Contact Samtec

| SMP | J | TYPE | PLATING | ORIENTATION | BULLET LENGTH | CABLE END |
|-----|---|------------------------|--|-------------------|-----------------------------|--|
| | | -B = Bullet Adaptor | -GF = 10 μ" (0.25 μm) Gold center contact, Gold Flash outer contact | -ST = Straight | Leave blank for cable end | Leave blank for bullet type |
| | | -C = Cable End | -RA = Right-angle (Not available with -B) | | -0645 = 6.45 mm (.254") | -CA7 = RG 405 (.086" DIA) Semi-flexible Cable |
| | | | | | -1450 = 14.50 mm (.571") | -CA5 = CCA-25M Cable |
| | | | | | | -CS5 = MWC-2550-01 25 AWG Microwave Cable |

Due to technical progress, all designs, specifications and components are subject to change without notice.

WWW.SAMTEC.COM

All parts within this catalog are built to Samtec's specifications. Customer specific requirements must be approved by Samtec and identified in a Samtec customer-specific drawing to apply.

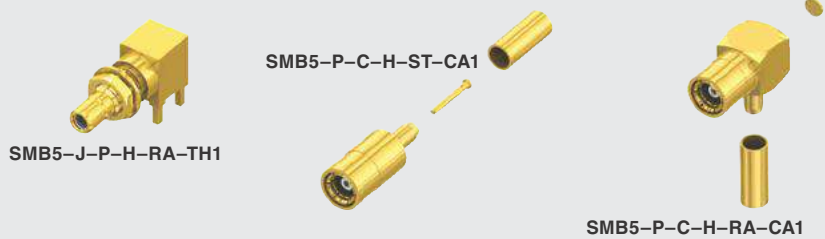

SMB5 SERIES

50 Ω SMB JACKS & PLUGS

Mates with:
RF174, RF316, GRF1H-C

SPECIFICATIONS

For complete specifications and recommended PCB layouts see www.samtec.com?SMB5-TH

Shell Material: Brass

Contact Material: Brass

Insulator Material: PTFE

Impedance: 50 Ω

Frequency Range: 0-4 GHz

Working Voltage: 250 Vrms max

Dielectric Withstanding: 750 Vrms min

Operating Temp Range: -65 °C to +165 °C

RoHS Compliant: Yes

PROCESSING

Lead-Free Solderable: Yes

Note: 75 Ω version available. See SMB7H Series.

| SMB5 | GENDER | TYPE | PLATING | ORIENTATION | TERMINATION |
|------|--------------|-------------------|--|----------------------|------------------------|
| | -J = Jack | -P = PCB Mount | -H = 30 μ" (0.76 μm) Gold center contact, 3 μ" (0.08 μm) Gold outer contact | -RA = Right-angle | -TH1 = Through-hole |

SPECIFICATIONS

For complete specifications and assembly instructions see www.samtec.com?SMB5-CA

Shell Material: Brass

Contact Material: Brass (-J), Phosphor Bronze (-P-ST), BeCu (-P-RA)

Center Contact: Soldered

Outer Ferrule: Crimped

Insulator Material: PTFE

Impedance: 50 Ω

Frequency Range: 0-4 GHz

Working Voltage: 335 Vrms max

Dielectric Withstanding: 1000 Vrms min

Operating Temp Range: -65 °C to +165 °C

| SMB5 | GENDER | TYPE | PLATING | ORIENTATION | TERMINATION |
|------|------------------------------|---------------|--|---|--|
| | -P = Plug -J = Jack | -C = Cable | -H = 30 μ" (0.76 μm) Gold center contact, 3 μ" (0.08 μm) Gold outer contact | -ST = Straight -RA = Right-angle (-P only) | -CA1 = RG 174/316 Cable (-P only) -CA2 = RG 178 Cable (-J only) -BH1 = RG 316 Cable (-J only) |

Supplied with pins, washers, nuts and ferrules. See website for dimensions.

Due to technical progress, all designs, specifications and components are subject to change without notice.

WWW.SAMTEC.COM

All parts within this catalog are built to Samtec's specifications. Customer specific requirements must be approved by Samtec and identified in a Samtec customer-specific drawing to apply.

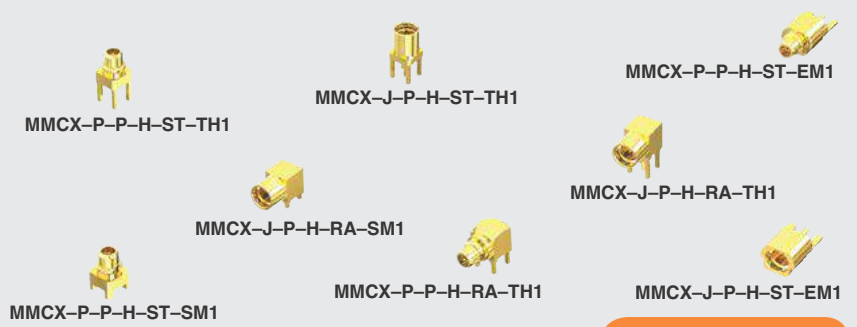

MMCX SERIES

50 Ω MMCX MICRO-MINI JACKS & PLUGS

Mates with:
RF174, RF316, RF178,
RS316, GRF1H-C

SPECIFICATIONS

For complete specifications and recommended PCB layouts see www.samtec.com?MMCX-EM, www.samtec.com?MMCX-MT, www.samtec.com?MMCX-SM or www.samtec.com?MMCX-TH

- Contact Material:** BeCu
- Insulator Material:** PTFE
- Pin and Shell Material:** Brass
- Operating Temp Range:** -65 °C to +125 °C
- Impedance:** 50 Ω
- Dielectric Withstanding Voltage:** 500 Vrms, 50 Hz
- Dielectric Working Voltage:** 170 Vrms, 50Hz
- Frequency Range:** 0-6 GHz
- RoHS Compliant:** Yes

PROCESSING

Lead-Free Solderable: Yes

| MMCX | GENDER | TYPE | PLATING | ORIENTATION | TERMINATION |
|------|---------------------|--------------------------|---|---|---|
| | -J = Jack | -P = PCB Mount | -H = 30 μ" (0.76 μm) Gold center contact, 3 μ" (0.08 μm) Gold outer contact | -RA = Right-angle -ST = Straight | -TH1 = Through-hole -MT1 = Mixed Technology (-ST only) -SM1 = Surface Mount -EM1 = Edge Mount (-ST only) |

OTHER SOLUTIONS

- High Vibration jacks and plugs. These connectors are not interchangeable with the MMCX.
 - MMCX Jack that switches from internal to external antenna when cable is mated.
- Contact Samtec.

Notes:
Random vibration and Resonant Search test reports available online.

75 Ω version available. See MMCX7 Series.

| MMCX | GENDER | TYPE | PLATING | ORIENTATION | TERMINATION |
|------|---------------------|--------------------------|---|---|--|
| | -P = Plug | -P = PCB Mount | -H = 30 μ" (0.76 μm) Gold center contact, 3 μ" (0.08 μm) Gold outer contact | -RA = Right-angle -ST = Straight | -TH1 = Through-hole -MT1 = Mixed Technology (-ST only) -SM1 = Surface Mount (-ST only) -EM1 = Edge Mount (-ST only) |

Due to technical progress, all designs, specifications and components are subject to change without notice.

WWW.SAMTEC.COM

All parts within this catalog are built to Samtec's specifications. Customer specific requirements must be approved by Samtec and identified in a Samtec customer-specific drawing to apply.



MCX-J-P-H-RA-SM1



MCX-J-P-H-ST-SM1



MCX-J-P-H-ST-EM1



MCX-J-P-H-RA-TH1



MCX-J-P-H-ST-TH1



MCX-P-P-H-ST-TH2

MCX SERIES

50 Ω MCX MINI JACKS & PLUGS

Mates with:

RF174, RF316, RF178, RS316, GRF1H-C

SPECIFICATIONS

For complete specifications and recommended PCB layouts see www.samtec.com?MCX-TH, www.samtec.com?MCX-SM, www.samtec.com?MCX-EM or www.samtec.com?MCX-MT

Insulator Material:

PTFE

Contact Material:

BeCu, Brass (-P-TH)

Shell Material:

Brass

Operating Temp Range:

-65 °C to +125 °C

Impedance:

50 Ω

Dielectric Withstanding Voltage:

1000 Vrms min, 50 Hz

Dielectric Working Voltage:

335 Vrms max

Frequency Range:

0-6 GHz

RoHS Compliant:

Yes

PROCESSING

Lead-Free Solderable:

Yes

| MCX | GENDER | TYPE | PLATING | ORIENTATION | TERMINATION |
|-----|---------------------|--------------------------|---|---|---|
| | -J = Jack | -P = PCB Mount | -H = 30 μ" (0.76 μm) Gold center contact, 3 μ" (0.08 μm) Gold outer contact | -RA = Right-angle -ST = Straight | -TH1 = Through-hole -SM1 = Surface Mount -EM1 = Edge Mount (-ST only) -MT1 = Mixed Technology (-ST only) |

| MCX | GENDER | TYPE | PLATING | ORIENTATION | TERMINATION |
|-----|---------------------|--------------------------|---|---|---|
| | -P = Plug | -P = PCB Mount | -H = 30 μ" (0.76 μm) Gold center contact, 3 μ" (0.08 μm) Gold outer contact | -RA = Right-angle -ST = Straight | -TH1 = Through-hole (-RA only) -TH2 = Elevated Through-hole (-ST only) |

Note:
75 Ω version available. See MCX7 Series.

Due to technical progress, all designs, specifications and components are subject to change without notice.

WWW.SAMTEC.COM

All parts within this catalog are built to Samtec's specifications. Customer specific requirements must be approved by Samtec and identified in a Samtec customer-specific drawing to apply.

MMCX-P-C-H-RA-CA2



MCX-J-C-H-ST-CA1



MCX-P-C-H-RA-CA1



MMCX-CA, MCX-CA SERIES

50 Ω MMCX & MCX COMPONENTS

SPECIFICATIONS

For complete specifications and assembly instructions see www.samtec.com?MMCX-CA

- Shell Material: Brass
- Insulator Material: PTFE
- Lead, Contact Socket and Outer Conductor Material: BeCu with Au plating
- Center Contact: Soldered
- Outer Ferrule: Crimped
- Operating Temp Range: -65 °C to +125 °C
- Impedance: 50 Ω
- Dielectric Withstanding Voltage: 500 Vrms, 50 Hz
- Dielectric Working Voltage: 170 Vrms, 50 Hz
- Frequency Range: 0-6 GHz (Cable dependent)

MMCX

GENDER

TYPE

PLATING

ORIENTATION

TERMINATION

-P
= Plug

-C
= Cable

-H
= 30 μ" (0.76 μm) Gold center contact, 3 μ" (0.08 μm) Gold outer contact (-CA1 & -CA2 only)

-HF
= 30 μ" (0.76 μm) Gold center contact, 3 μ" (0.08 μm) Gold outer contact (-CA1S only)

-RA
= Right-angle

-ST
= Straight

-CA1
= RG 174/316 Cable

-CA2
= RG 178 Cable

-CA1S
= RG 316 Cable, Double Shield (-ST only)

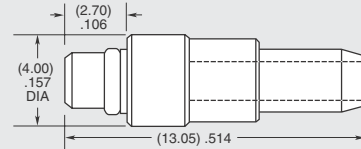
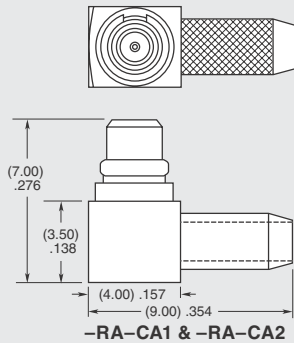

-RA-CA1 & -RA-CA2

-ST-CA1, -ST-CA2 & -ST-CA1S

Supplied with pins and ferrules. See website for dimensions.

SPECIFICATIONS

For complete specifications and assembly instructions see www.samtec.com?MCX-CA

- Insulator Material: PTFE
- Contact Material: BeCu
- Shell and Pin Material: Brass
- Center Contact: Soldered
- Outer Ferrule: Crimped
- Operating Temp Range: -65 °C to +125 °C
- Impedance: 50 Ω
- Frequency Range: 0-6 GHz (Cable dependent)
- Dielectric Withstanding Voltage: 1,000 Vrms min, 50 Hz
- Dielectric Working Voltage: 335 Vrms max.

MCX

GENDER

TYPE

PLATING

ORIENTATION

TERMINATION

-J
= Jack

-P
= Plug

-C
= Cable

-H
= 30 μ" (0.76 μm) Gold center contact, 3 μ" (0.08 μm) Gold outer contact (-CA1 & -CA2 only)

-HF
= 30 μ" (0.76 μm) Gold center contact, 3 μ" (0.08 μm) Gold outer contact (-CA1S only)

-RA
= Right-angle (-P only)

-ST
= Straight

-CA1
= RG 174/316 Cable

-CA2
= RG 178 Cable

-CA1S
= RG 316 Cable, Double Shield (-ST only)

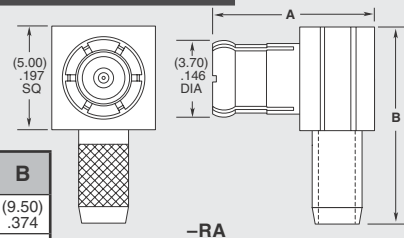

| TYPE (-RA) | A | B |
|------------|-------------|--------------|
| -P-CA1 | (7.78) .306 | (9.50) .374 |
| -P-CA2 | (8.58) .338 | (10.00) .394 |

| TYPE (-ST) | E | F |
|------------|-------------|--------------|
| -J-CA1 | (4.50) .177 | (15.50) .610 |
| -J-CA2 | (4.78) .188 | (15.00) .591 |
| -J-CA1S | (4.50) .177 | (15.50) .610 |

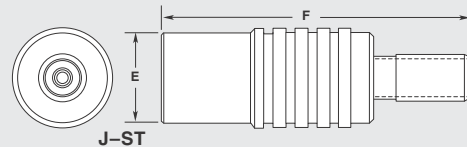
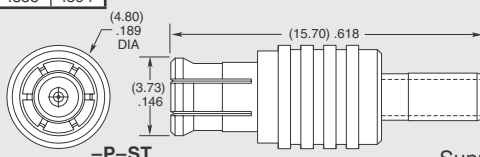

Supplied with pins and ferrules. See website for dimensions.

Due to technical progress, all designs, specifications and components are subject to change without notice.

WWW.SAMTEC.COM

All parts within this catalog are built to Samtec's specifications. Customer specific requirements must be approved by Samtec and identified in a Samtec customer-specific drawing to apply.

BNC5-P-C-GN-ST-CA1



BNC5-J-C-GN-ST-BH1



BNC5 SERIES

50 Ω BNC CABLE COMPONENTS

SPECIFICATIONS

For complete specifications and assembly instructions see www.samtec.com?BNC5-CA

- Shell Material:**
Brass
- Contact Material:**
Brass (-P)
Copper Alloy (-J)
- Center Contact:**
Soldered
- Outer Contact:**
Crimped
- Impedance:**
50 Ω
- Frequency Range:**
0-4 GHz
(Cable dependent)
- Working Voltage:**
500 Vrms max
- Dielectric Withstanding:**
1500 Vrms min
- Operating Temp Range:**
-65 °C to +125 °C

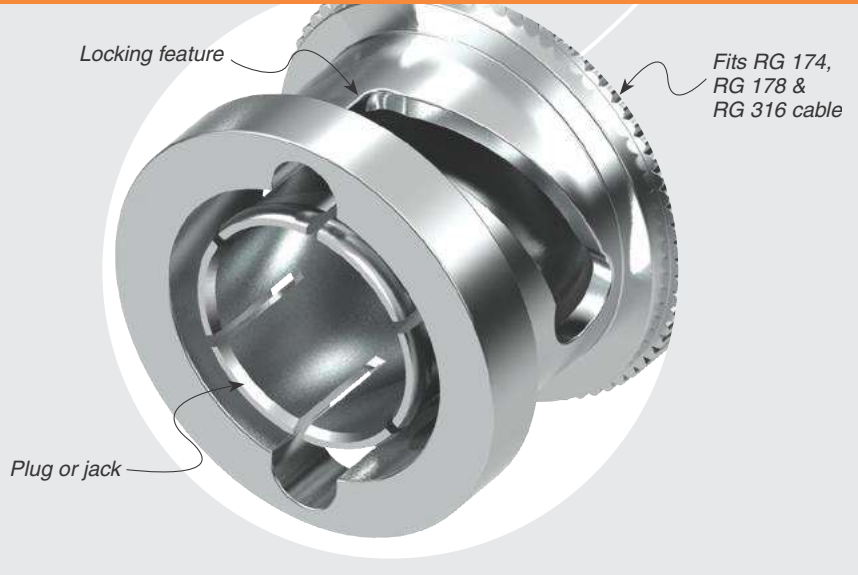

OTHER SOLUTIONS

- 50 Ω BNC Board Jacks
 - 50 Ω TNC Board Jacks
 - 50 Ω TNC Cable Components
- Contact Samtec.

| BNC5 | GENDER | TYPE | PLATING | ORIENTATION | TERMINATION |
|------|---|------------------------------|---|----------------------------------|---|
| | <p>-P = Plug</p> <p>-J = Jack</p> | <p>-C = Cable</p> | <p>-GN = 10 μ" (0.25 μm) Gold on contact, Nickel on body</p> | <p>-ST = Straight</p> | <p>-CA1 = RG 174 / 316 Cable (-P only)</p> <p>-CA2 = RG 178 Cable (-P only)</p> <p>-BH1 = Bulkhead, RG 174 / 316 Cable (-J only)</p> <p>-BH2 = Bulkhead, RG 178 Cable (-J only)</p> <p>-BH1S = Bulkhead, RG 316 Cable, Double Shield (-J only)</p> |
| | | | | | |
| | | | | | |
| | | | | | |
| | | | | | |

Supplied with pins, washers, nuts, gaskets and ferrules. See website for dimensions.
Due to technical progress, all designs, specifications and components are subject to change without notice.

WWW.SAMTEC.COM

All parts within this catalog are built to Samtec's specifications.
 Customer specific requirements must be approved by Samtec and identified in a Samtec customer-specific drawing to apply.

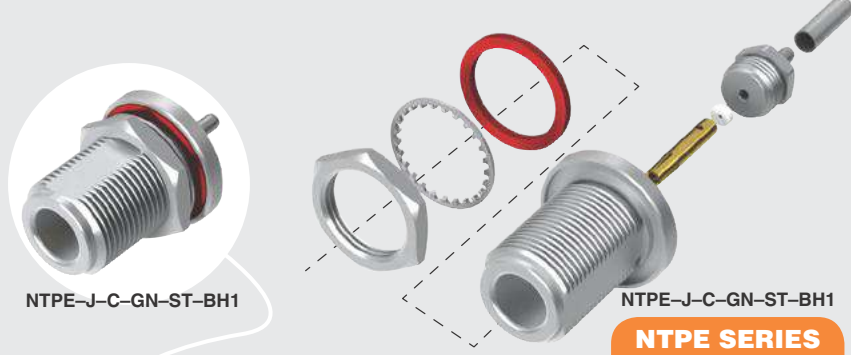

NTPE-J-C-GN-ST-BH1

NTPE-J-C-GN-ST-BH1

NTPE SERIES

50 Ω N TYPE RF COMPONENTS

SPECIFICATIONS

For complete specifications and assembly instructions see www.samtec.com?NTPE-CA

Shell Material:

Brass

Contact Material:

Phosphor Bronze

Insulator Material:

PTFE

Center Contact:

Soldered

Outer Contact:

Crimped

Impedance:

50 Ω

Frequency Range:

0~3 GHz

(Cable dependent)

Working Voltage:

1000 Vrms max

Dielectric Withstanding:

2500 Vrms min

Operating Temp Range:

-65 °C to +125 °C

NTPE
GENDER
TYPE
PLATING
ORIENTATION
TERMINATION
-J
= Jack

-C
= Cable

-GN
= 10 μ"
(0.25 μm)
Gold on
contact,
Nickel on
body

-ST
= Straight

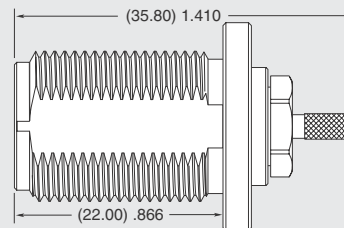
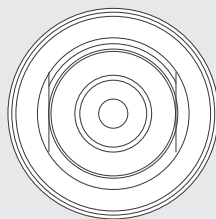
-BH1
= Bulkhead,
RG 174 &
RG 316 Cable

Supplied with pins, washers, nuts, gaskets and ferrules. See website for dimensions.

Due to technical progress, all designs, specifications and components are subject to change without notice.

WWW.SAMTEC.COM

All parts within this catalog are built to Samtec's specifications.

Customer specific requirements must be approved by Samtec and identified in a Samtec customer-specific drawing to apply.

TNC-J-C-GN-ST-BH1



TNC-J-P-H-RA-TH1



TNC SERIES

50 Ω TNC JACKS & PLUGS

Mates with:

RF058, RF178, RF316,
RF174, GRF1H-C

SPECIFICATIONS

For complete specifications and recommended PCB layouts see www.samtec.com?TNC-TH

- Outer Contact Material:** Ni plated Brass
- Center Contact Material:** Au plated Phosphor Bronze
- Insulator Material:** PTFE
- Operating Temperature:** -65 °C to +125 °C
- Impedance:** 50 Ω
- Frequency Range:** 0~6 GHz
- Working Voltage:** 500 Vrms max
- Dielectric Withstanding:** 1500 Vrms min
- RoHS Compliant:** Yes

PROCESSING

Lead-Free Solderable: Yes

| TNC | GENDER | TYPE | PLATING | ORIENTATION | TERMINATION |
|-----|--------------|-------------------|--|----------------------|------------------------|
| | -J = Jack | -P = PCB Mount | -H = 30 μ" (0.76 μm) Gold on center contact, Nickel on Shell | -RA = Right-angle | -TH1 = Through-hole |

Note:
While optimized for 50 Ω applications, this connector can also perform well in certain 75 Ω applications.
Contact RFGroup@samtec.com for further information.

SPECIFICATIONS

For complete specifications and assembly instructions see www.samtec.com?TNC-CA

- Shell Material:** Brass
- Contact Material:** Brass (-P-ST), Phosphor Bronze (-J)
- Center Contact:** Soldered
- Outer Ferrule:** Crimped
- Impedance:** 50 Ω
- Frequency Range:** 0~3 GHz (Cable dependent)
- Working Voltage:** 500 Vrms max
- Dielectric Withstanding:** 1500 Vrms min
- Operating Temp Range:** -65 °C to +125 °C

ALSO AVAILABLE (MOQ Required)

- IP67 sealed option
Contact Samtec.

| TNC | GENDER | TYPE | PLATING | ORIENTATION | TERMINATION |
|-----|----------------------------------|---------------|---|---|---|
| | -P = Plug -J = Jack | -C = Cable | -GN = 10 μ" (0.25 μm) Gold on contact, Nickel on body | -ST = Straight -SR = Straight Reverse Polarity (-P only) | -CA1 = RG 174 / 316 Cable (-P & -ST only) -CA2 = RG 178 Cable (-P & -ST only) -C10 = RG 58 Cable (-P & -SR only) -BH1 = Bulkhead, RG 174 / 316 Cable (-J & -ST only) -BH2 = Bulkhead, RG 178 Cable (-J & -ST only) |

Supplied with pins, washers, nuts and ferrules. See website for dimensions.

Due to technical progress, all designs, specifications and components are subject to change without notice.

DIN7A-PP-C-GF-ST-CA3

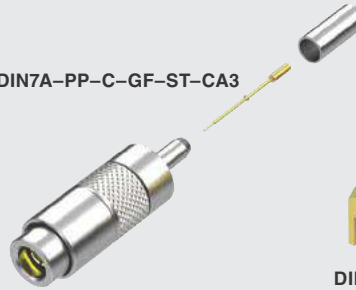

DIN7A-J-P-GF-RA-BH1

DIN7A-J-P-GF-ST-TH1



DIN7A SERIES

75 Ω DIN 1.0/2.3 JACKS & PLUGS

Mates with:
RFB8T, RFA6T, RFB6T,
RF179, GRF7H-C

SPECIFICATIONS

For complete specifications see
www.samtec.com?DIN7A-TH,
www.samtec.com?DIN7A-BH or
www.samtec.com?DIN7A-CA

Shell Material:

Brass

Contact:

Copper Alloy

Insulator Material:

PTFE

Operating Temp Range:

-65 °C to +125 °C

Impedance:

75 Ω

Working Voltage:

250 Vrms

Dielectric Withstanding:

750 Vrms

| DIN7A | GENDER | TYPE | PLATING | ORIENTATION | TERMINATION |
|-------|----------------|-------------------|--|---|--|
| | -J = Jack | -P = PCB Mount | -GF = 10 μ" (0.25 μm) Gold center contact, 3 μ" (0.08 μm) Gold outer contact, (100 μ" (2.54 μm) Nickel body -RA only) | -ST = Straight (-TH1 only) -RA = Right-angle (-BH1 only) | -TH1 = Through-hole (-ST only) -BH1 = Bulkhead Through-hole (-RA only) |
| | <p>-ST-TH1</p> | | | | |
| | <p>-RA-BH1</p> | | | | |

Notes:
12G-SDI available for PCB mounts only.
Contact RFTechnicalGroup@samtec.com for 12G-SDI PCB mount launch characteristics.
Designed to meet SMPTE 2082 12G-SDI specifications.

| DIN7A | PP | TYPE | PLATING | ORIENTATION | TERMINATION |
|-------------------|-------------------------|---------------|--|-------------------|--|
| | -PP = Push Pull Plug | -C = Cable | -GF = 10 μ" (0.25 μm) Gold on contact, Flash Gold on outer contact, Nickel on shell | -ST = Straight | -CA3 = RG 179 Cable -CA6 = RG 6 or Belden 1694A Cable -CA8 = Belden 1855A Cable |
| <p>-CA6 SHOWN</p> | | | | | |

Supplied with pins and ferrules. See website for dimensions.

Due to technical progress, all designs, specifications and components are subject to change without notice.

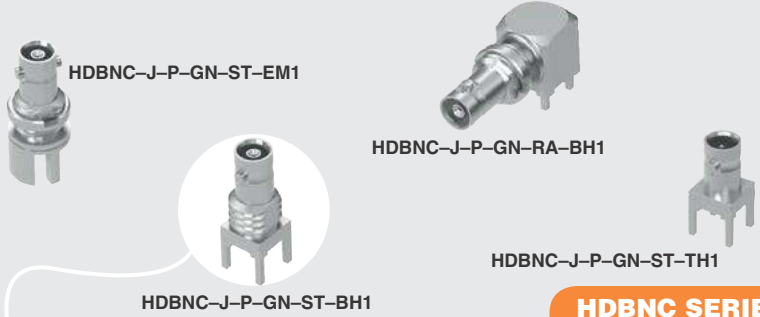

HDBNC SERIES

75 Ω HIGH-DENSITY BNC JACKS

SPECIFICATIONS

For complete specifications and recommended PCB layouts see www.samtec.com?HDBNC-TH, www.samtec.com?HDBNC-BH1 or www.samtec.com?HDBNC-EM

- Shell Material:** Au plated Brass
- Contact Material:** Copper Alloy
- Insulator Material:** PTFE
- Impedance:** 75 Ω ±2 Ω
- Voltage Rating:** 500 VAC
- Dielectric Withstanding:** 1500 Vrms min
- Operating Temperature:** -65 °C to +125 °C
- RoHS Compliant:** Yes
- Lead-Free Solderable:** Yes

Mates with: RFB6T, RFB8T, RFA6T

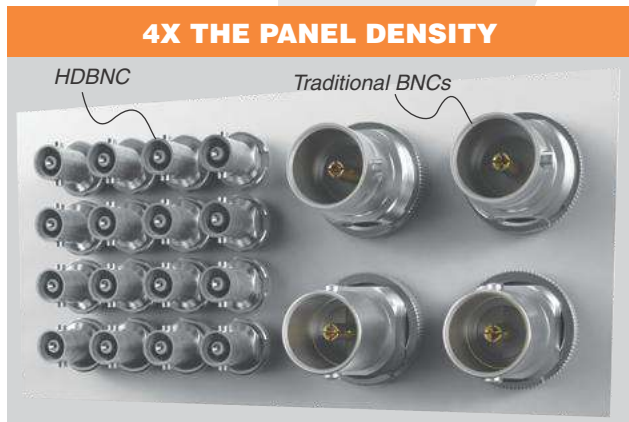

Patented design and bayonet latch

20% reduction in weight of traditional BNCs

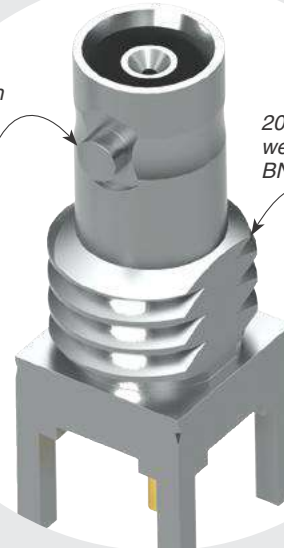

Extended performance of 12G for high density terminations

| HDBNC | GENDER | TYPE | PLATING | ORIENTATION | TERMINATION |
|-------|--------|------|---|---|--|
| -J | = Jack | -P | -GN = 10 μ" (0.25 μm) Gold contact, 100 μ" (2.54 μm) Nickel shell | -ST = Straight -RA = Right-angle | -BH1 = Through-hole -BH2 = Through-hole (2.36 mm) .093 Board (-RA only) -EM1 = Edge Mount (-ST only) -TH1 = Through-hole (-ST only) |

EXTRACTION TOOL

- Hand tool for quickly installing/uninstalling HDBNC Series.
Part Number: CAT-EX-HDBNC-01
Contact Samtec.

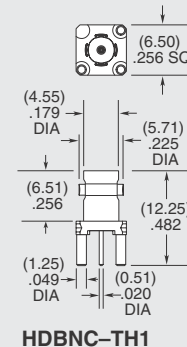
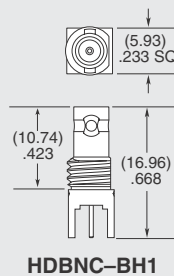
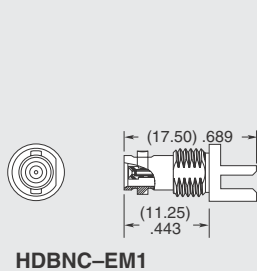
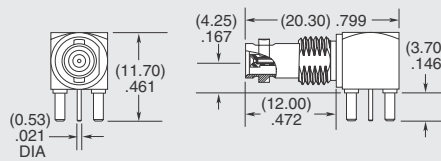

Notes:
Compatible with Amphenol's HD-BNC™
Designed to meet SMPTE 424M 12G-SDI specifications.

Due to technical progress, all designs, specifications and components are subject to change without notice.

WWW.SAMTEC.COM

All parts within this catalog are built to Samtec's specifications. Customer specific requirements must be approved by Samtec and identified in a Samtec customer-specific drawing to apply.

HDBNC-P-C-GN-ST-CA8

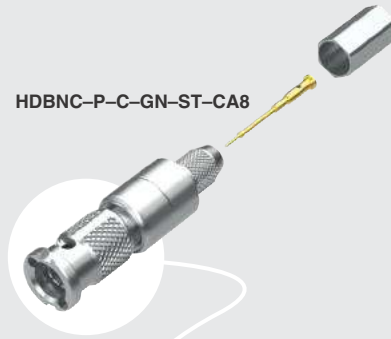

HDBNC-P-C-GN-ST-CA6



HDBNC-CA SERIES

75 Ω HIGH-DENSITY BNC COMPONENTS

SPECIFICATIONS

For complete specifications and assembly instructions see www.samtec.com?HDBNC-CA

Shell Material:

Brass

Contact Material:

Brass

Center Contact:

Soldered

Outer Ferrule:

Crimped

Impedance:

75 Ω

Voltage Rating:

500 VAC

Dielectric Withstanding:

1000 Vrms

Operating Temperature:

-65 °C to +125 °C

Crimp style plugs use industry standard termination tools



Choice of RG 6, Belden 1694A or Belden 1855A cable terminations

EXTRACTION TOOL

- Hand tool for quickly installing/uninstalling HDBNC Series. Part Number: CAT-EX-HDBNC-01 Contact Samtec.

HDBNC

GENDER

TYPE

PLATING

ORIENTATION

TERMINATION

-P
= Plug

-C
= Cable

-GN
= 10 μ" (0.25 μm)
Gold on contact,
Nickel on outer
contact and shell

-ST
= Straight

-CA6
= RG 6 or
Belden 1694A Cable

-CA8
= Belden 1855A Cable

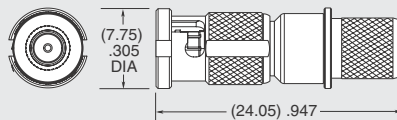

HDBNC-CA6

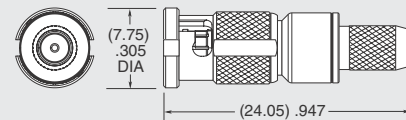

HDBNC-CA8

Notes:
Compatible with Amphenol's HD-BNC™

Supplied with pins and ferrules. See website for dimensions.

Due to technical progress, all designs, specifications and components are subject to change without notice.

WWW.SAMTEC.COM

All parts within this catalog are built to Samtec's specifications.

Customer specific requirements must be approved by Samtec and identified in a Samtec customer-specific drawing to apply.

BNC7T-J-P-GN-ST-TH1



BNC7T-J-P-GN-ST-EM2



BNC7T-J-C-GN-ST-BH3

BNC7T SERIES

75 Ω MACHINED BNC JACKS & PLUGS

Mates with:
RF179, RFA6T,
RFB6T, GRF7H-C

SPECIFICATIONS

For complete specifications and recommended PCB layouts see www.samtec.com?BNC7T-TH, www.samtec.com?BNC7T-BH or www.samtec.com?BNC7T-EM

Shell Material:
Ni plated Brass
Contact Material:
TH1 & BH1 = Copper Alloy
Insulator Material:
PTFE
Impedance:
ST = 75 Ω ±2 Ω
RA = 75 Ω ±4 Ω
Frequency Range:
0-12 GHz
Working Voltage:
500 Vrms
Dielectric Withstanding:
1500 Vrms min
Operating Temperature:
-65 °C to +125 °C
RoHS Compliant:
Yes
Lead-Free Solderable: Yes

Notes:
12G-SDI available for PCB mounts only.
Contact RFTechnicalGroup@samtec.com for 12G-SDI PCB mount launch characteristics.
Designed to meet SMPTE 2082 12G-SDI specifications.

| BNC7T | GENDER | TYPE | PLATING | ORIENTATION | TERMINATION |
|--------------|--------|-------------------|--|---|---|
| -J = Jack | | -P = PCB Mount | -GN = 10 μ" (0.25 μm) Gold contact, 100 μ" (2.54 μm) Nickel shell | -ST = Straight -RA = Right-angle Bulkhead/ Panel Mount | -TH1 = Standard Through-hole -BH1* = Standard Bulkhead Through-hole (-RA only) -EM1* = Edge Mount Bulkhead/Panel Mount for (1.60 mm) .062" PCB (-ST only) -EM2* = Edge Mount Bulkhead/Panel Mount for (2.40 mm) .093" PCB (-ST only) |

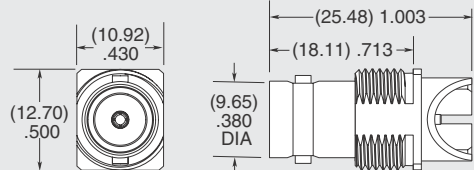

-ST-EM1 & -ST-EM2

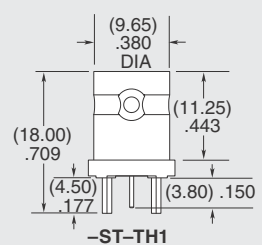

-ST-TH1

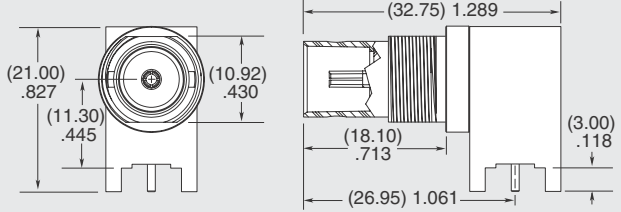

-RA-BH1

* Lock washers & knurled nuts supplied with Bulkhead/Panel Mount options

TOOL
Tool for quickly installing/uninstalling knurl nut for BNC7T Series
Part Number: TOOL-BNC7T-01

SPECIFICATIONS

For complete specifications and assembly instructions see www.samtec.com?BNC7T-CA

Shell Material:
Brass
Contact Material:
Brass (-P), Copper Alloy (-J)
Center Contact:
Soldered
Outer Ferrule:
Crimped
Impedance:
75 Ω
Working Voltage:
500 Vrms
Dielectric Withstanding:
1500 Vrms min
Operating Temperature:
-65 °C to +125 °C

| BNC7T | GENDER | TYPE | PLATING | ORIENTATION | TERMINATION |
|------------------------------|--------|---------------|---|---|--|
| -P = Plug -J = Jack | | -C = Cable | -GN = 10 μ" (0.25 μm) Gold on contact, Nickel on outer contact and shell | -ST = Straight -RA = Right-angle (-P only) | -CA3 = RG 179 Cable (-P only) -CA6 = RG 6 or Belden 1694A Cable (-P only) -BH3 = Bulkhead, RG 179 Cable (-J only) |

| TERMINATION | C (DIA) |
|-------------|-------------|
| -CA3 | (2.70) .106 |
| -CA6 | (6.85) .270 |

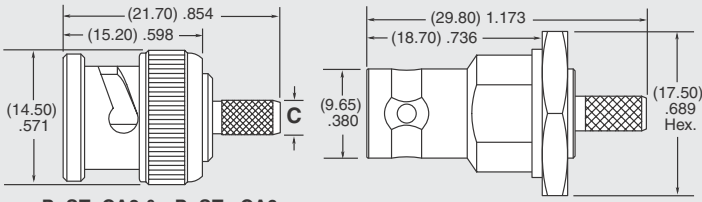

-P-ST-CA3 & -P-ST-CA6

-J-ST-BH3

Supplied with pins, ferrules, washers, nuts and gaskets. See website for dimensions.

Due to technical progress, all designs, specifications and components are subject to change without notice.



BNC7T-J-P-GN-RA-BH2D

BNC7T-J-P-GN-ST-TH2D

BNC7T-P-C-GN-ST-CA3D

BNC7T SERIES

75 Ω DIE CAST BNC JACKS & PLUGS

Mates with:
RF179, RFA6T,
RFB6T, GRF7H-C

SPECIFICATIONS

For complete specifications and recommended PCB layouts see www.samtec.com?BNC7T-TH, www.samtec.com?BNC7T-BH, www.samtec.com?BNC7T-BM or www.samtec.com?BNC7T-EM

Shell Material: Zinc
Contact Material: Copper Alloy
Insulator Material: PTFE
Impedance:
ST = 75 Ω ±2 Ω
RA = 75 Ω ±4 Ω
Frequency Range: 0-12 GHz
Working Voltage: 500 Vrms
Dielectric Withstanding: 1500 Vrms min
Operating Temperature: -65 °C to +125 °C
RoHS Compliant: Yes
Lead-Free Solderable: Yes

TOOL

Tool for quickly installing/uninstalling knurl nut for BNC7T Series
Part Number:
TOOL-BNC7T-01

Notes:
12G-SDI available for PCB mounts only.

Contact RFTechnicalGroup@samtec.com for 12G-SDI PCB mount launch characteristics.

Designed to meet SMPTE 2082 12G-SDI specifications.

| BNC7T | GENDER | TYPE | PLATING | ORIENTATION | TERMINATION |
|-------|--------------|-------------------|---|---|---|
| | -J = Jack | -P = PCB Mount | -GN = 10 μ" (0.25 μm) Gold contact, 100 μ" (2.54 μm) Nickel shell | -ST = Straight -RA = Right-angle Bulkhead/ Panel Mount | -TH2D = Tall Through-hole Die Cast -BH2D* = Die Cast Bulkhead Through-hole (-RA only) -BM1D* = Low Profile Mixed Technology Die Cast Bulkhead for (1.60 mm) .062" PCB (-RA only) -EM1D* = Edge Mount Die Cast Bulkhead/Panel Mount for (1.60 mm) .062" PCB (-ST only) -EM2D* = Edge Mount Die Cast Bulkhead/Panel Mount for (2.40 mm) .093" PCB (-ST only) |

* Lock washers & knurled nuts supplied with Bulkhead/Panel Mount options

SPECIFICATIONS

For complete specifications and assembly instructions see www.samtec.com?BNC7T-CA

Shell Material: Zinc
Contact Material: Brass
Center Contact: Soldered
Outer Ferrule: Crimped
Impedance: 75 Ω
Working Voltage: 500 Vrms
Dielectric Withstanding: 1500 Vrms min
Operating Temperature: -65 °C to +125 °C

| BNC7T | GENDER | TYPE | PLATING | ORIENTATION | TERMINATION |
|-------|--------------|---------------|---|-------------------|--|
| | -P = Plug | -C = Cable | -GN = 10 μ" (0.25 μm) Gold contact, 100 μ" (2.54 μm) Nickel shell | -ST = Straight | -CA3D = RG 179 Cable Die Cast -CA6D = RG 6 or Belden 1694A Cable Die Cast |

Supplied with pins, ferrules, washers, nuts and gaskets. See website for dimensions.

WWW.SAMTEC.COM

Due to technical progress, all designs, specifications and components are subject to change without notice.

All parts within this catalog are built to Samtec's specifications. Customer specific requirements must be approved by Samtec and identified in a Samtec customer-specific drawing to apply.

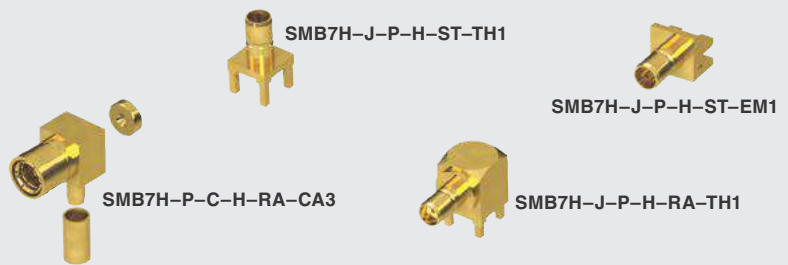

SMB7H SERIES

75 Ω OPTIMIZED SMB JACKS & PLUGS

SPECIFICATIONS

For complete specifications and recommended PCB layouts see www.samtec.com?SMB7H-TH or www.samtec.com?SMB7H-EM

- Shell Material:** Brass
- Contact Material:** Brass
- Insulator Material:** PTFE
- Impedance:** ST = 75 Ω ±3 Ω
RA = 75 Ω ±4 Ω
- Frequency Range:** 0~4 GHz
- Working Voltage:** 335 Vrms max
- Dielectric Withstanding:** 1000 Vrms min
- Operating Temperature:** -65 °C to +165 °C
- RoHS Compliant:** Yes
- Lead-Free Solderable:** Yes

SMB7H

GENDER

TYPE

PLATING

ORIENTATION

TERMINATION

Mates with:
RF179, GRF7H-C

-J
= Jack

-P
= PCB Mount

-H
= 30 μ" (0.76 μm)
Gold center contact,
3 μ" (0.08 μm)
Gold outer contact

-ST
= Straight
-RA
= Right-angle

-TH1
= Through-hole
(0.90 mm) .035" DIA
Signal Pin
-TH2
= Through-hole
(0.51 mm) .020" DIA
Signal Pin
-EM1
= Edge Mount
(-ST only)

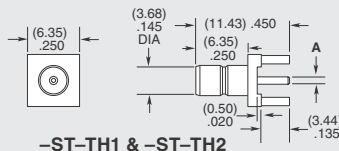
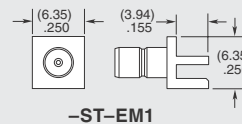
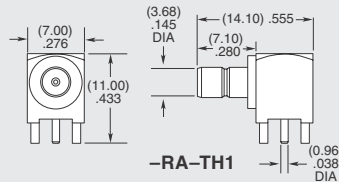

| TERMINATION | A (DIA) |
|-------------|-------------|
| -TH1 | (0.90) .035 |
| -TH2 | (0.51) .020 |

SPECIFICATIONS

For complete specifications and assembly instructions see www.samtec.com?SMB7H-CA

- Shell Material:** Brass
- Contact Material:** BeCu
- Insulator Material:** PTFE
- Center Contact:** Soldered
- Outer Ferrule:** Crimped
- Impedance:** 75 Ω
- Frequency Range:** 0~8 GHz (-ST)
0~7 GHz (-RA)
- Working Voltage:** 335 Vrms max
- Dielectric Withstanding:** 1000 Vrms min
- Operating Temperature:** -65 °C to +165 °C

SMB7H

GENDER

TYPE

PLATING

ORIENTATION

TERMINATION

-P
= Plug

-C
= Cable

-H
= 30 μ" (0.76 μm)
Gold center contact,
3 μ" (0.08 μm)
Gold outer contact
(-ST only)

-ST
= Straight
-RA
= Right-angle

-CA3
= RG 179 Cable

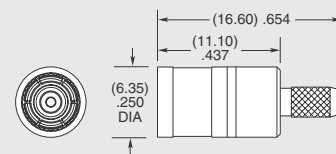
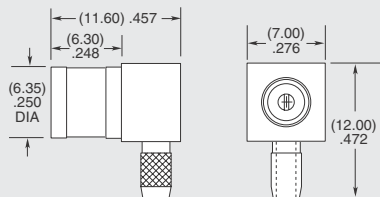

-P-RA

-P-ST

Supplied with pins and ferrules. See website for dimensions.

Due to technical progress, all designs, specifications and components are subject to change without notice.

WWW.SAMTEC.COM

All parts within this catalog are built to Samtec's specifications. Customer specific requirements must be approved by Samtec and identified in a Samtec customer-specific drawing to apply.



ORIGINAL RF SOLUTIONS

100 Ω SYSTEMS

| | |
|--|----|
| Shielded Twisted Pair Twinax Cable (C28S)..... | 62 |
| Twinax Jack (CJT)..... | 63 |

75 Ω SYSTEMS

| | |
|--|-------|
| 75 Ω Micro-Mini Ganged Cable (GRF7H-C)..... | 68-69 |
| 75 Ω Micro-Mini Ganged Connectors (GRF7-J, GRF7-P)..... | 70 |
| 75 Ω MMCX Jacks & Plugs (MMCX7)..... | 72 |
| 75 Ω MCX Jacks/Plugs & Cable Components (MCX7)..... | 73 |

50 Ω SYSTEMS

| | |
|--|-------|
| 50 Ω Micro-Mini Ganged Connectors (GRF1-J, GRF1-P)..... | 64 |
| 50 Ω Micro-Mini Ganged Cable (GRF1-C, GRF1H-C)..... | 65-67 |
| 50 Ω , 30 AWG Flexible Cable Assembly, (.047" DIA) (RF047)..... | 71 |
| 50 Ω IsoRate [®] Cable (IJ5C, IJ5H)..... | 74-75 |
| 50 Ω IsoRate [®] Connectors (IJ5, IP5)..... | 76-77 |

APPLICATIONS

| | |
|----------------------------|----|
| Original RF Solutions..... | 14 |
|----------------------------|----|

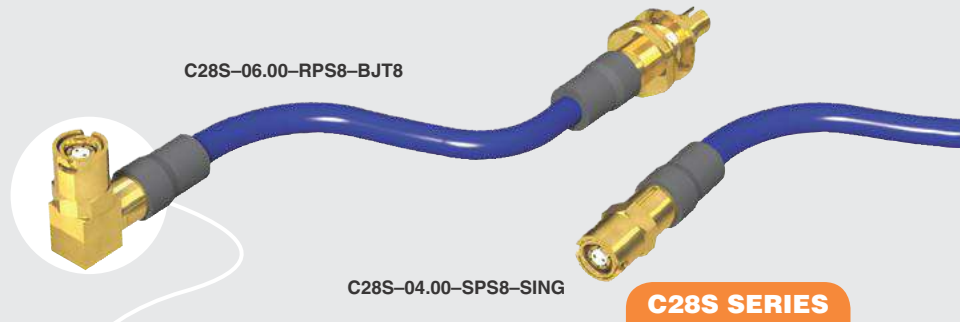

C28S SERIES

100 Ω CIRCULAR RF TWINAX CABLE

SPECIFICATIONS

For complete specifications see www.samtec.com?C28S

RF CONNECTOR

Outer Contact Material:
Phosphor Bronze (Plug),
Brass (Jack)
Center Contact Material:
Phosphor Bronze (Terminals),
BeCu (Sockets)
Insulator Material:
PTFE
Operating Temperature:
-40 °C to +85 °C
Voltage Rating:
200 VAC
Frequency Range:
0 - 4 GHz
Impedance:
100 Ω
RoHS Compliant:
Yes

Mates with:
CJT, C28S

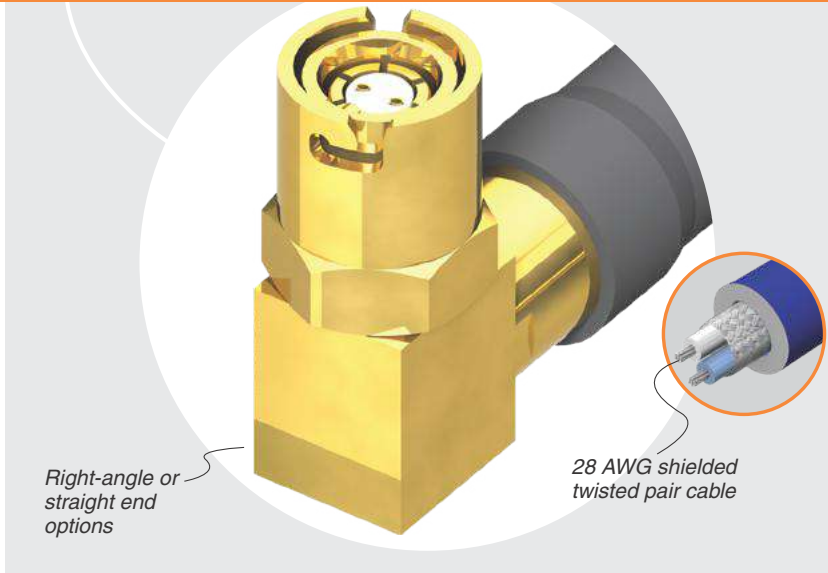

CABLE

Cable:
28 AWG shielded
twisted pair
Signal Routing:
100 Ω Differential
Jacket Material:
PVC
Insulator Material:
FEP
RoHS Compliant:
Yes

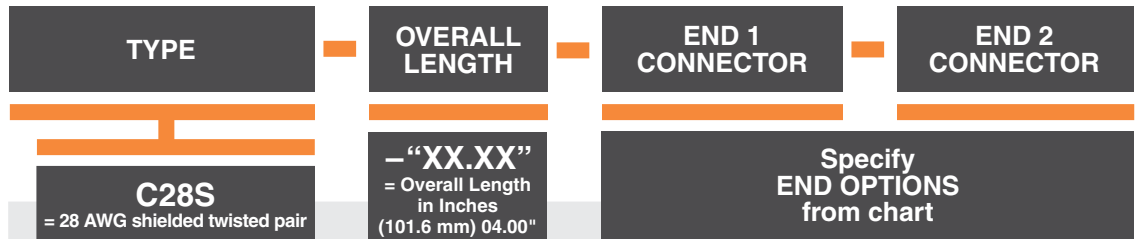

C28S
= 28 AWG shielded twisted pair

– “XX.XX”
= Overall Length
in Inches
(101.6 mm) 04.00”
minimum

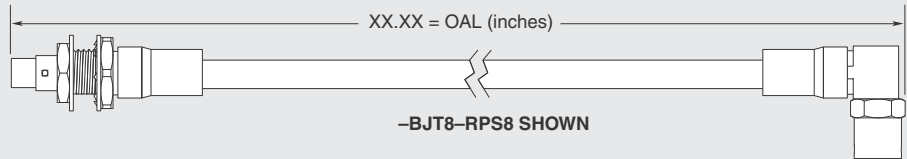

| END OPTIONS | |
|---|--|
| –SPS8 = Straight Plug with Sockets (30 μm (0.76 μm) Gold on Center and Outer Contact, Gold Flash on Shell) | |
| –RPS8 = Right-angle Plug with Sockets (30 μm (0.76 μm) Gold on Center and Outer Contact, Gold Flash on Shell) | |
| –BJT8 = Bulkhead Jack with Terminals (30 μm (0.76 μm) Gold on Center and Outer Contact, Gold Flash on Shell) | |
| –SING = Single Ended (End 2 callout) | |
| –XXXXXX = Stripped & Tinned (End 2 callout) (See chart for callout) | |

STRIPPED & TINNED
(Dimensions in inches)

| CALLOUT | A | B | C |
|---------|-----|-----|-----|
| –303030 | .30 | .30 | .30 |
| –303040 | .30 | .30 | .40 |
| –403030 | .40 | .30 | .30 |
| –403040 | .40 | .30 | .40 |

Both center conductors and braid shield are stripped, only the center conductors are tinned.

ALSO AVAILABLE
(MOQ Required)

- Additional stripping and tinning options
Contact Samtec.

Note:
Cable lengths longer than 36.00" (0.92 meter) are not supported with S.I. test data.

Due to technical progress, all designs, specifications and components are subject to change without notice.



CJT-T-P-HH-RA-TH1



CJT-T-P-HH-RA-BH1



CJT SERIES

100 Ω CIRCULAR RF TWINAX JACK

SPECIFICATIONS

For complete specifications and recommended PCB layouts see www.samtec.com?CJT-TH or www.samtec.com?CJT-BH

- Shell Material:**
Brass
- Insulator Material:**
PTFE
- Contact Material:**
Phosphor Bronze
- Operating Temperature:**
-20 °C to +105 °C
- Frequency Range:**
0 - 4 GHz
- Working Voltage:**
200 VAC
- Impedance:**
100 Ω
- RoHS Compliant:**
Yes
- Lead-Free Solderable:**
Yes

Mates with:
C28S

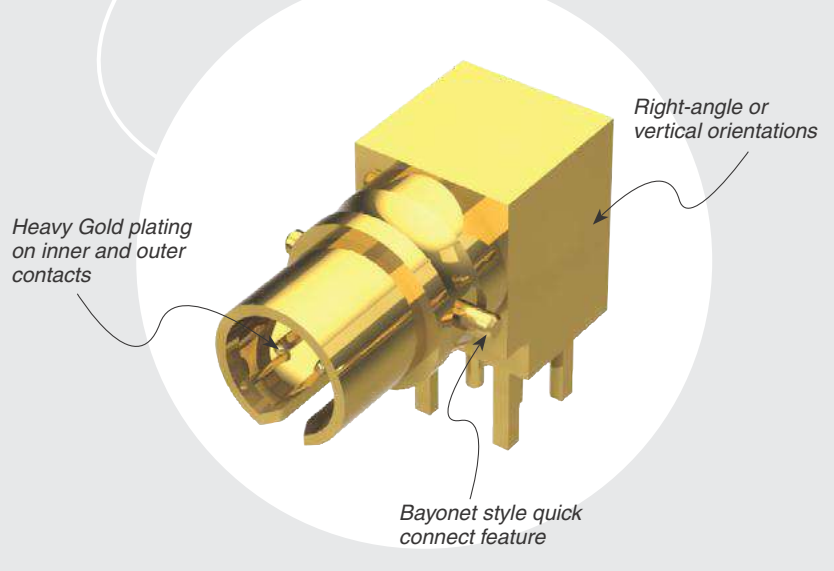

| CJT | GENDER | TYPE | PLATING | ORIENTATION | TERMINATION |
|-----|--------|-------------------|--|---|---|
| -T | | -P = PCB Mount | -HH = 30 μ" (0.76 μm) Gold on pins and outer contact | -ST = Straight -RA = Right-angle | -TH1 = Standard Through-hole -BH1* = Standard Bulkhead Through-hole (-RA only) |

-ST-TH1

-RA-TH1

-RA-BH1*

* Lock washer, nut and gasket supplied unassembled with Bulkhead option.

Due to technical progress, all designs, specifications and components are subject to change without notice.

GRF1-P-P-08-E-ST-TH1

GRF1-P-P-04-E-ST-TH1

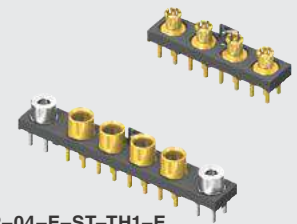
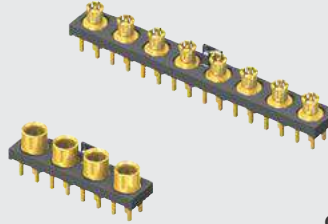

GRF1-J-P-04-E-ST-TH1

GRF1-J-P-04-E-ST-TH1-E

GRF1-J, GRF1-P SERIES

(5.00 mm) .197"

50 Ω GANGED MICRO-MINI RF SYSTEMS

SPECIFICATIONS

For complete specifications and recommended PCB layouts see www.samtec.com?GRF1-J or www.samtec.com?GRF1-P

Shell Material:

Brass
Insulator Material:
 PTFE

Contact Material:

BeCu

Pin Material:

Brass

Plating:

30 μ" (0.76 μm) Au

over 50 μ" (1.27 μm) Ni

Current Rating (GRF1-J/GRF1-P):

Signals: 3.6 A per pin

(8 adjacent pins powered)

Grounds: 6.2 A per pin

(8 adjacent pins powered)

Operating Temp Range:

-40 °C to +90 °C

Impedance:

50 Ω

Dielectric

Withstanding Voltage:

500 Vrms, 50 Hz

Dielectric Working Voltage:

170 Vrms, 50 Hz

Frequency Range:

0-6 GHz

RoHS Compliant:

Yes

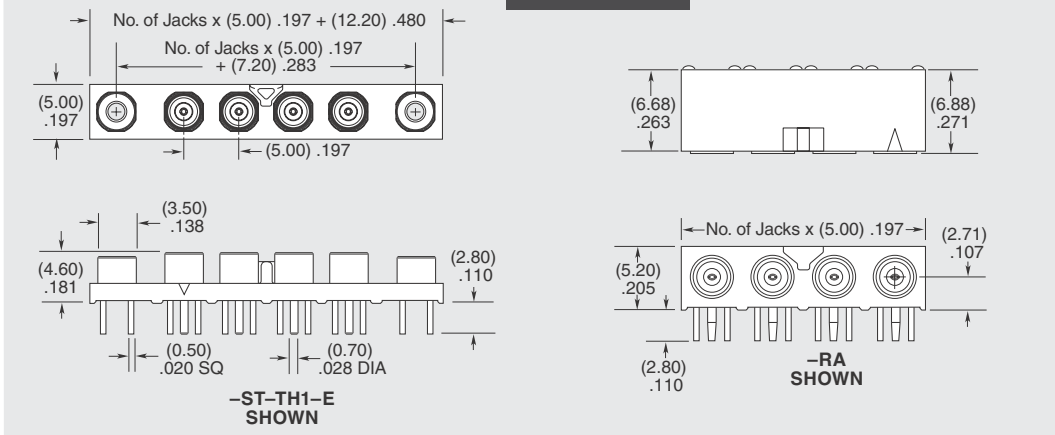
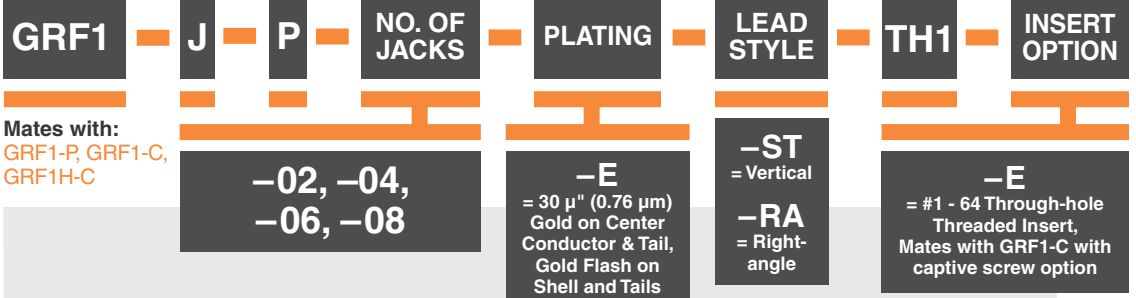

PROCESSING

Lead-Free Solderable:

Yes

RECOGNITIONS

For complete scope of recognitions see www.samtec.com/quality



FILE NO. E111594

APPLICATION

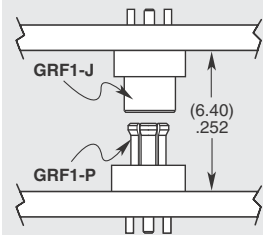

OTHER SOLUTIONS

- Cable assembly (see GRF1-C Series)

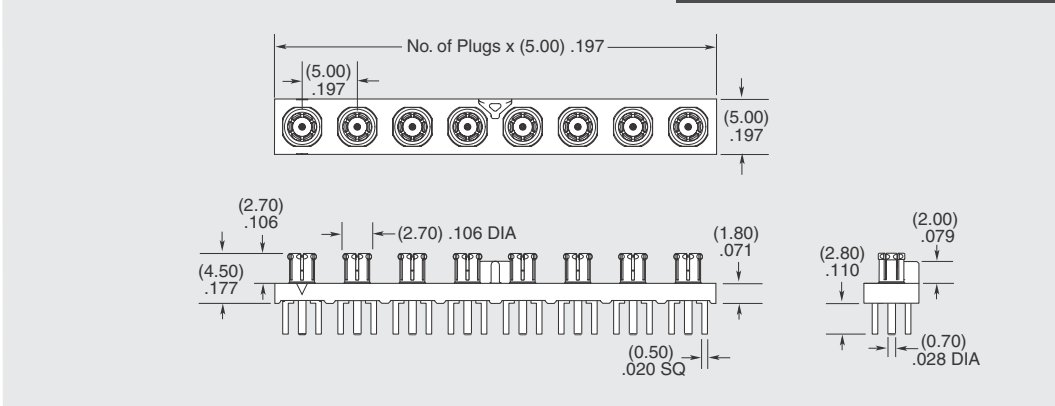
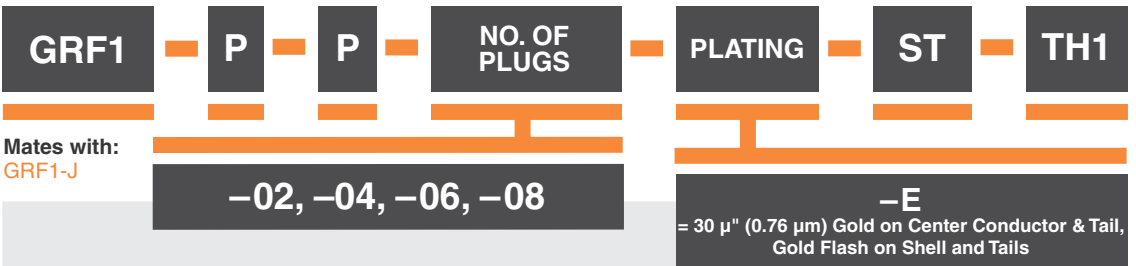

Due to technical progress, all designs, specifications and components are subject to change without notice.

WWW.SAMTEC.COM

All parts within this catalog are built to Samtec's specifications.

Customer specific requirements must be approved by Samtec and identified in a Samtec customer-specific drawing to apply.

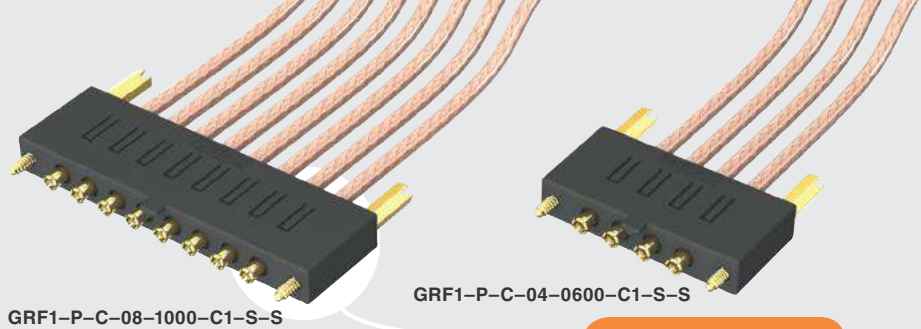

GRF1-C SERIES

(5.00 mm) .197"

50 Ω GANGED MICRO-MINI RF CABLE

SPECIFICATIONS

For complete specifications see www.samtec.com?GRF1-C

- Shell Material:** Brass
- Insulator Material:** PTFE
- Contact Material:** BeCu
- Pin Material:** Brass
- Plating:** 30 μ" (0.76 μm) Au over 50 μ" (1.27 μm) Ni
- Operating Temp Range:** -40 °C to +90 °C
- Impedance:** 50 Ω
- RoHS Compliant:** Yes

- RG 316 Cable:**
- Impedance:** 50 Ω
- Capacitance:** 96.432 pF/meter
- Propagation Delay:** 4.83 nsec/meter
- Max Attenuation (cable only):** 1.25 dB @ 1 GHz for 1 meter
- Conductor Size:** 26 AWG, (0.51 mm) .020" dia.
- Conductor Material:** Silver Plated Copper
- Insulator Diameter:** (1.52 mm) .060"
- Insulator Material:** PTFE
- Shield Material:** Silver Plated Copper Clad Steel
- Jacket Material:** FEP
- Jacket Diameter:** (2.54 mm) .100"
- Jacket Color:** Amber
- Bend Radius:** 12.7 mm
- RoHS Compliant:** Yes

Mates with:
GRF1-J

TOOLING

Application Tooling.
Contact atg@samtec.com for more information.

OTHER SOLUTIONS

- 50 Ω Board-to-Board system (see GRF1-J & GRF1-P Series)

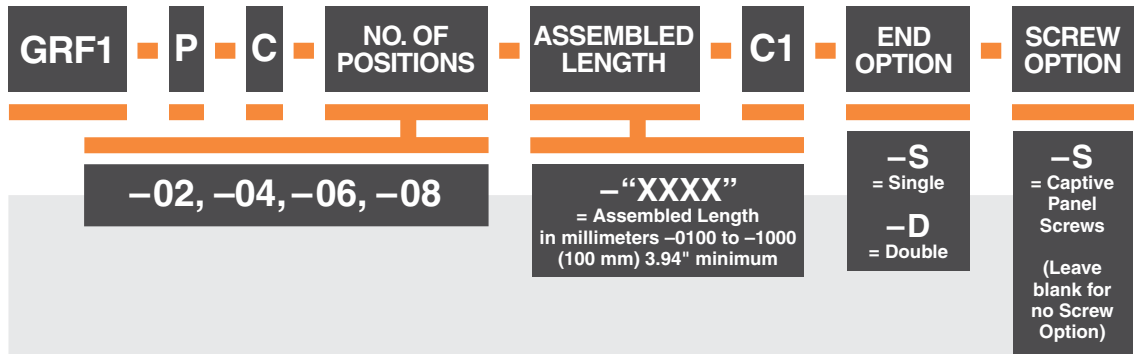
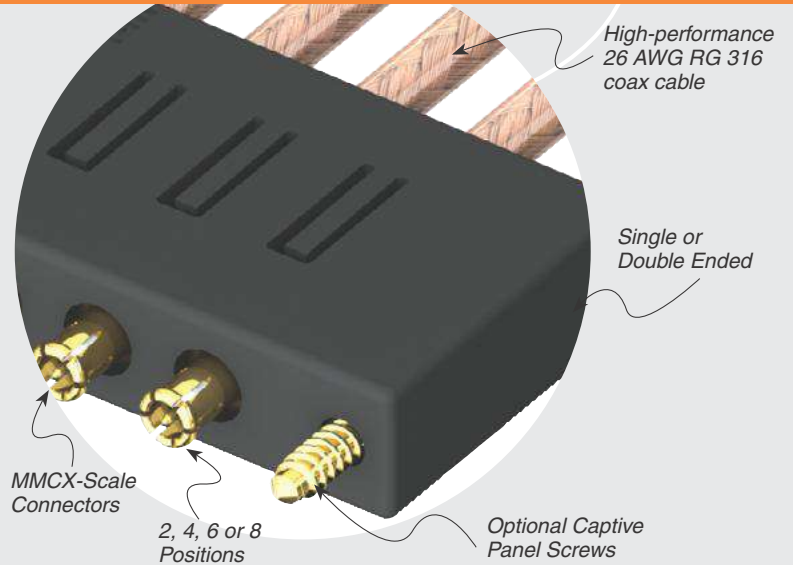

RECOGNITIONS

For complete scope of recognitions see www.samtec.com/quality



Notes:
Cable lengths longer than 40.00" (1 meter) are not supported with S.I. test data.
This Series is non-standard, non-returnable.

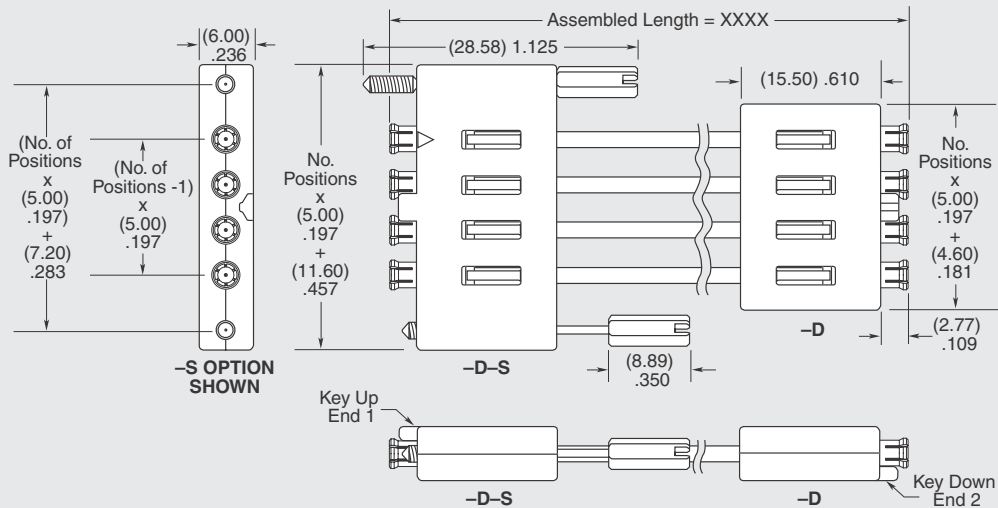

Due to technical progress, all designs, specifications and components are subject to change without notice.

WWW.SAMTEC.COM

All parts within this catalog are built to Samtec's specifications.
Customer specific requirements must be approved by Samtec and identified in a Samtec customer-specific drawing to apply.

GRF1H-4-0300-1-CA1-S-02SP1

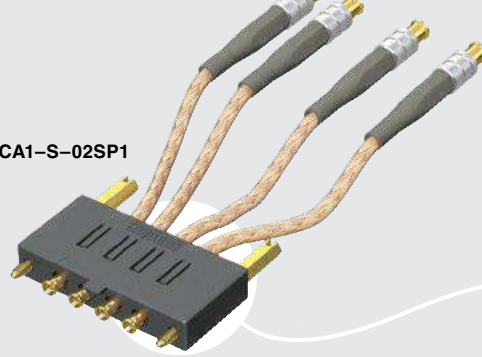

(5.00 mm) .197"

50 Ω HYBRID MICRO-MINI RF CABLE

SPECIFICATIONS

For complete specifications see www.samtec.com?GRF1H-C

RF Connector:

Shell Material:
Brass
(GRF, SMA, MCX, MMCX, SMB, BNC)

Insulator Material:
PTFE

Contact Material:
Brass
(GRF, SMA, MCX, MMCX, SMB-J, BNC-P, TNC-P)
Phosphor Bronze
(SMB-P-ST, TNC-J, N Type)

BeCu
(SMB-P-RA)
Copper Alloy
(BNC-J)

Operating Temp Range:
-40 °C to +90 °C

Impedance:
50 Ω

RoHS Compliant:
Yes

RG 316 Cable:

Impedance:
50 Ω

Capacitance:
96.432 pF/meter

Propagation Delay:
4.83 nsec/meter

Max Attenuation (cable only):
1.25 dB @ 1 GHz for 1 meter

Conductor Size:
26 AWG,
(0.51 mm) .020" dia.

Conductor Material:
Silver Plated Copper

Insulator Material:
PTFE

Shield Material:
Silver Plated

Copper Clad Steel

Jacket Material:
FEP

Jacket Diameter:
(2.54 mm) .100"

Jacket Color:
Amber

Bend Radius:
12.7 mm

RoHS Compliant:
Yes

Mates with:
GRF1-J, SMA,
MCX, SMB5, MMCX,
BNC5, TNC, NTPE

High-performance
26 AWG RG 316
coax cable

2, 4, 6 or 8
Positions

MMCX-Scale
Connectors

Optional Captive
Panel Screws

GRF1H

NO. OF
POSITIONS

ASSEMBLED
LENGTH

-2, -4, -6, -8

- "XXXX"

= Assembled Length in millimeters
-0100 (0100 mm) 3.94" minimum

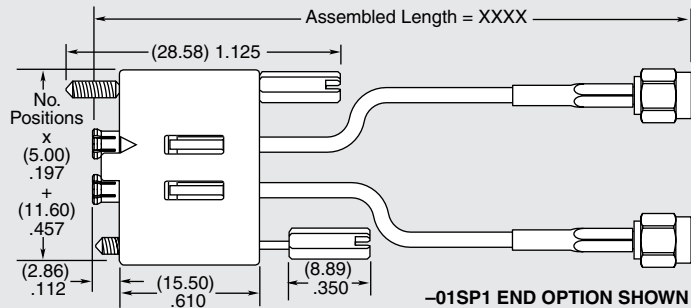
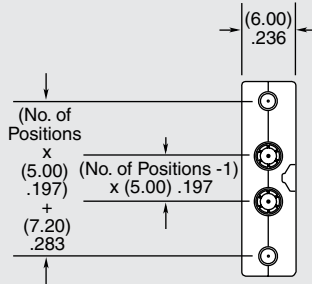

-01SP1 END OPTION SHOWN

RECOGNITIONS

For complete scope of recognitions see www.samtec.com/quality



Notes:

Cable lengths longer than 40.00" (1 meter) are not supported with S.I. test data.

This series is non-standard, non-returnable.

| END OPTIONS | | END OPTIONS | |
|--|--|---|--|
| -01SP1 = SMA Straight Plug (30 μ" (0.76 μm) Gold on Center Contact, Gold Flash on Shell) | | -07SP1 = SMB Straight Plug (30 μ" (0.76 μm) Gold on Center Contact, Gold Flash on Shell) | |
| -01RP1 = SMA Right-angle Plug (30 μ" (0.76 μm) Gold on Center Contact, Gold Flash on Shell) | | -07RP1 = SMB Right-angle Plug (30 μ" (0.76 μm) Gold on Center Contact, Gold Flash on Shell) | |
| -01PN1 = SMA Straight Panel Mount Jack (30 μ" (0.76 μm) Gold on Center Contact, Gold Flash on Shell) | | -02SJ1 = MCX Straight Jack (30 μ" (0.76 μm) Gold on Center Contact, Gold Flash on Shell) | |

Due to technical progress, all designs, specifications and components are subject to change without notice.

WWW.SAMTEC.COM

All parts within this catalog are built to Samtec's specifications.

Customer specific requirements must be approved by Samtec and identified in a Samtec customer-specific drawing to apply.

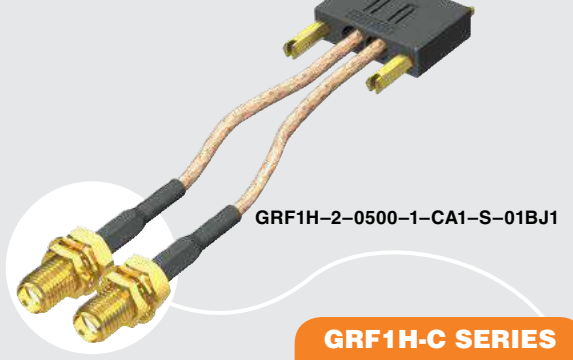

GRF1H-C SERIES

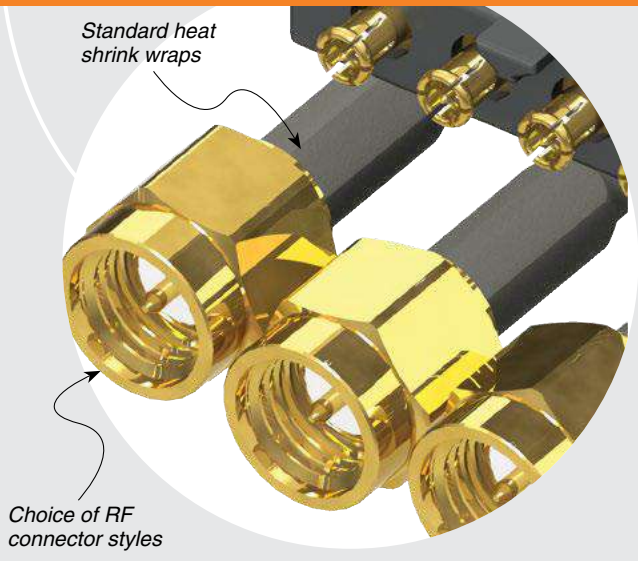

END 1 PLATING

-1
= All Gold components

CABLE TYPE

-CA1
= RG 316 cable

SCREW OPTION

-S
= Captive Panel Screws
(Leave blank for no Screw Option)

END 2 OPTION

Specify END OPTIONS from chart

| END OPTIONS | | END OPTIONS | | END OPTIONS | |
|---|--|---|--|--|--|
| <p>-02SP1 = MCX Straight Plug (30 μ" (0.76 μm)) Gold on Center Contact, Gold Flash on Shell)</p> | | <p>-05SP3 = TNC Straight Plug (10 μ" (0.25 μm)) Gold on Center Contact, Nickel on Shell)</p> | | <p>-07BJ1 = SMB Straight Bulkhead Jack (30 μ" (0.76 μm)) Gold on Center Contact, Gold Flash on Shell)</p> | |
| <p>-02RP1 = MCX Right-angle Plug (30 μ" (0.76 μm)) Gold on Center Contact, Gold Flash on Shell)</p> | | <p>-01BJ1 = SMA Straight Bulkhead Jack -01BR1 = SMA Straight Bulkhead Jack, Reversed Polarity -01SB1 = SMA Straight Bulkhead Jack, Sealed -01SR1 = SMA Straight Bulkhead Jack, Sealed, Reversed Polarity (30 μ" (0.76 μm)) Gold on Center Contact, Gold Flash on Shell)</p> | | <p>-04BJ2 = BNC Straight Bulkhead Jack (30 μ" (0.76 μm)) Gold on Center Contact, Nickel on Shell)</p> | |
| <p>-03SP1 = MMCX Straight Plug (30 μ" (0.76 μm)) Gold on Center Contact, Gold Flash on Shell)</p> | | | | <p>-05BJ3 = TNC Straight Bulkhead Jack (10 μ" (0.25 μm)) Gold on Center Contact, Nickel on Shell)</p> | |
| <p>-03RP1 = MMCX Right-angle Plug (30 μ" (0.76 μm)) Gold on Center Contact, Gold Flash on Shell)</p> | | | | <p>-06BJ2 = N Type Straight Bulkhead Jack (30 μ" (0.76 μm)) Gold on Center Contact, Nickel on Shell)</p> | |
| <p>-04SP3 = BNC Straight Plug (10 μ" (0.25 μm)) Gold on Center Contact, Nickel on Shell)</p> | | | | | |

Due to technical progress, all designs, specifications and components are subject to change without notice.



GRF7H-4-0500-1-CA3-S-73SP1

(5.00 mm) .197"

75 Ω HYBRID MICRO-MINI RF CABLE

SPECIFICATIONS

For complete specifications see www.samtec.com?GRF7H-C

RF Connector:

Shell Material:
Brass
(GRF, MCX, SMB,
DIN, BNC, MMCX7-J)
BeCu
(MMCX7-P)

Insulator Material:
PTFE

Contact Material:
BeCu
(GRF, SMB)
Brass
(MCX, BNC-P, MMCX7)
Copper Alloy
(DIN, BNC-J)

Operating Temp Range:
-40 °C to +90 °C

Impedance:

75 Ω

RoHS Compliant:

Yes

RG 179 Cable:

Impedance:

75 Ω ±3 Ω

Capacitance:

64 pF/meter

Max Attenuation

(cable only):

0.8 dB @ 1 GHz for 1 meter

Conductor Size:

30 AWG, (0.31 mm) .012" dia.

Conductor Material:

Silver Plated Copper

Insulator Material:

PTFE

Shield Material:

Silver Plated Copper

Jacket Material:

FEP

Jacket Diameter:

(2.54 mm) .100"

Jacket Color:

Amber

Bend Radius:

10.2 mm

RoHS Compliant:

Yes

RECOGNITIONS

For complete scope of recognitions see www.samtec.com/quality



Notes:

Cable lengths longer than 40.00" (1 meter) are not supported with S.I. test data.

This series is non-standard, non-returnable.

Mates with:

GRF7-J, MCX7, MMCX7,
SMB7H, DIN7A, BNC7T

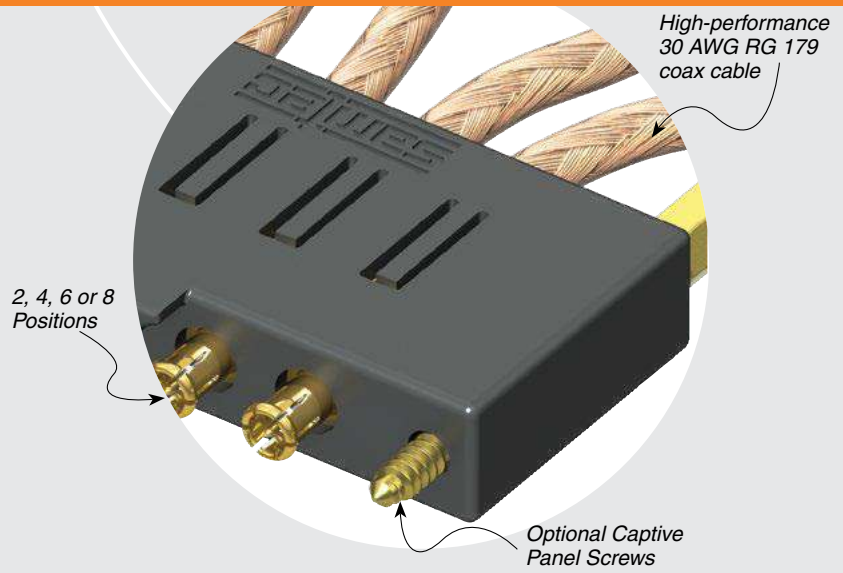

GRF7H

NO. OF POSITIONS

ASSEMBLED LENGTH

-2, -4, -6, -8

- "XXXX"

= Assembled Length in millimeters
-0100 (100 mm) 3.94" minimum

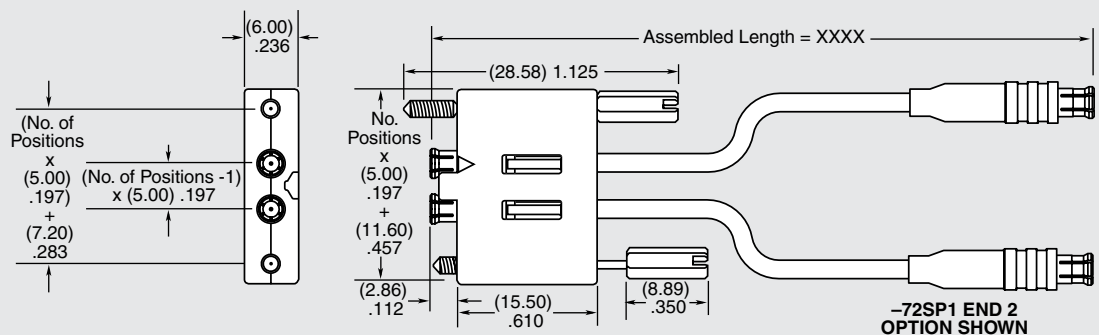

| END OPTIONS | | END OPTIONS | |
|--|--|--|--|
| -73SP1 = 75 Ω MMCX7 Straight Plug (30 μ" (0.76 μm) Gold on Center Contact, Gold Flash on Shell) | | -72SP1 = 75 Ω MCX Straight Plug (30 μ" (0.76 μm) Gold on Center Contact, Gold Flash on Shell) | |
| -73SJ1 = 75 Ω MMCX7 High Vibration Straight Jack (30 μ" (0.76 μm) Gold on Center Contact, Gold Flash on Shell) | | -72RP1 = 75 Ω MCX Right-angle Plug (30 μ" (0.76 μm) Gold on Center Contact, Gold Flash on Shell) | |

Due to technical progress, all designs, specifications and components are subject to change without notice.

WWW.SAMTEC.COM

All parts within this catalog are built to Samtec's specifications.

Customer specific requirements must be approved by Samtec and identified in a Samtec customer-specific drawing to apply.



GRF7H-2-0300-1-CA3-S-74BJ3

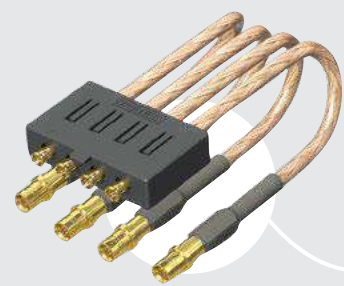

GRF7H-4-0800-1-CA3-73SJ1

GRF7H-C SERIES



Variety of standard straight and right-angle plugs and jacks

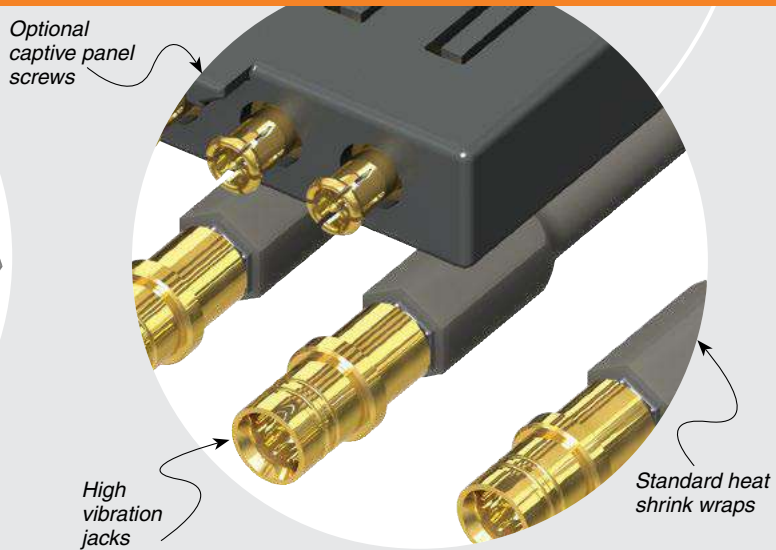

Optional captive panel screws

High vibration jacks

Standard heat shrink wraps

END 1 PLATING

-1

= All Gold components

CABLE TYPE

-CA3

= RG 179 cable

SCREW OPTION

-S

= Captive Panel Screws
(Leave blank for no Screw Option)

END 2 OPTION

Specify END OPTIONS from chart

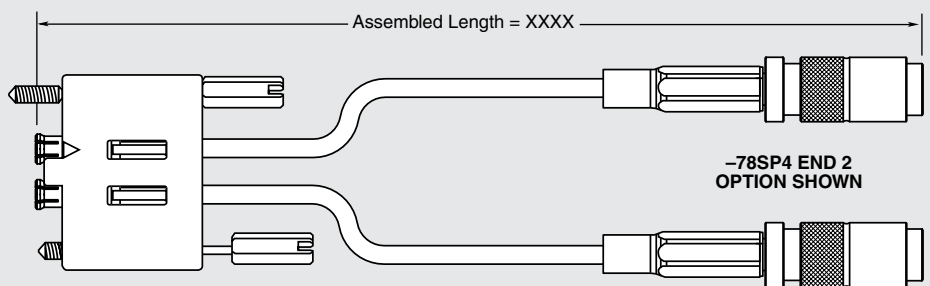

| END OPTIONS | |
|--|--|
| -77RP1 = 75 Ω SMB Right-angle Plug (30 μ" (0.76 μm) Gold on Center Contact, Gold Flash on Shell) | |
| -77SP1 = 75 Ω SMB Straight Plug (30 μ" (0.76 μm) Gold on Center Contact, Gold Flash on Shell) | |
| -78SP4 = 75 Ω DIN Straight Plug (10 μ" (0.25 μm) Gold on Center Contact, Nickel on Shell) | |

| END OPTIONS | |
|---|--|
| -74BJ3 = 75 Ω BNC Straight Bulkhead Jack (10 μ" (0.25 μm) Gold on Center Contact, Nickel on Shell) | |
| -74SP3* = 75 Ω BNC Straight Plug (10 μ" (0.25 μm) Gold on Center Contact, Nickel on Shell) (*Die Cast also available = -D4SP3) | |

Due to technical progress, all designs, specifications and components are subject to change without notice.

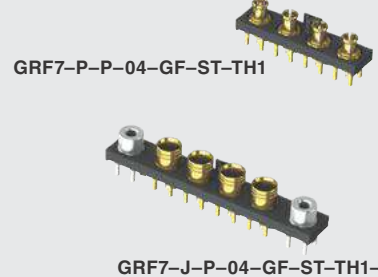
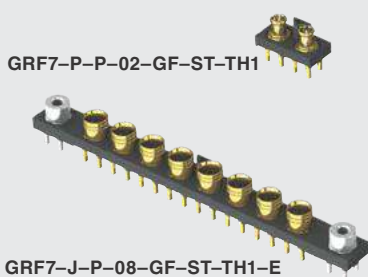

(5.00 mm) .197"

GRF7-J, GRF7-P SERIES

75 Ω GANGED MICRO-MINI RF SYSTEMS

SPECIFICATIONS

For complete specifications and recommended PCB layouts see www.samtec.com?GRF7-J or www.samtec.com?GRF7-P

- Housing Material:** ABS
- Shell Material:** Brass
- Insulator Material:** PTFE
- Contact Material:** BeCu
- Pin Material:** Brass
- Operating Temp Range:** -55 °C to +125 °C
- Impedance:** 75 Ω
- Dielectric Withstanding Voltage:** 500 Vrms, 50 Hz
- Dielectric Working Voltage:** 170 Vrms, 50 Hz
- Frequency Range:** 0-6 GHz
- RoHS Compliant:** Yes

PROCESSING

Lead-Free Solderable: Yes

RECOGNITIONS

For complete scope of recognitions see www.samtec.com/quality



FILE NO. E111594

APPLICATION

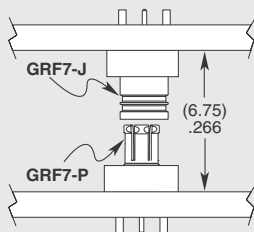

OTHER SOLUTIONS

- Cable assembly (see GRF7H-C Series)

| | | | | | | | |
|-----------------------------------|----------|----------|-------------------------------|---|---|---|----------------------|
| GRF7 | J | P | NO. OF JACKS | PLATING | LEAD STYLE | TH1 | INSERT OPTION |
| Mates with: GRF7-P, GRF7H-C | | | -02, -04, -06, -08 | -GF = 10 μ" (0.25 μm) Gold center contact, 3 μ" (0.08 μm) Gold outer contact | -ST = Vertical -RA = Right-angle | -E = #1 - 64 Through-hole Threaded Insert, Mates with GRF7-C with captive screw option | |

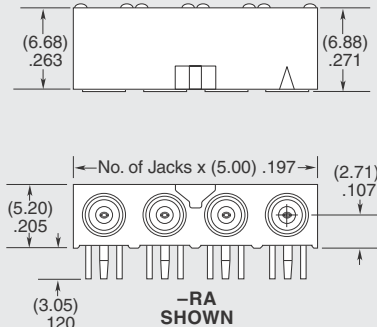
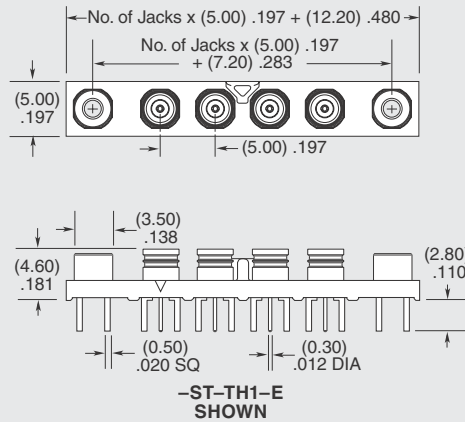

| | | | | | | |
|-----------------------|----------|----------|---------------------------|---|-----------|------------|
| GRF7 | P | P | NO. OF PLUGS | PLATING | ST | TH1 |
| Mates with: GRF7-J | | | -02, -04, -06, -08 | -GF = 10 μ" (0.25 μm) Gold center contact, 3 μ" (0.08 μm) Gold outer contact | | |

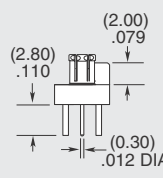
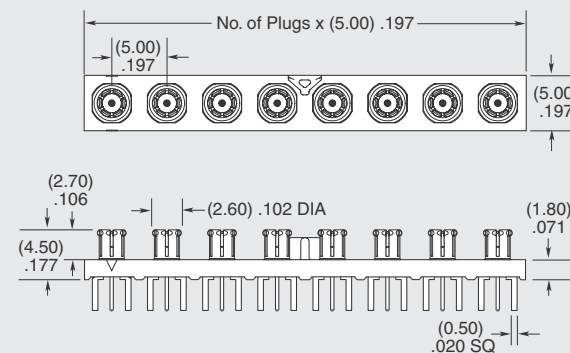

Due to technical progress, all designs, specifications and components are subject to change without notice.



RF047-11RP9-11SP9-0100



RF047-01SP1-11SP9-0100

RF047 SERIES

50 Ω .047" DIA FLEXIBLE CABLE

SPECIFICATIONS

For complete specifications see www.samtec.com?RF047

RF Connector:

Outer Contact Material:

Brass (SMA),
BeCu (HMHF1)

Contact Material:

Brass (SMA),
BeCu (HMHF1)

Insulator Material:

PTFE

Impedance:

50 Ω

Frequency Range:

0~10 GHz (HMHF1)

0~20 GHz (SMA)

Dielectric Withstanding:

1,000 Vrms (SMA)

CCA-047 (.047")

Cable:

Impedance:

50 Ω microwave

Capacitance:

95.14 pF/meter

Max Attenuation

(cable only):

1.15 @ 1 GHz for 1 meter

Conductor Size:

28 AWG (0.29 mm) .011" dia.

Conductor Material:

Silver plated copper

Insulator Material:

FEP

Shield Material:

Metallic Alloy

Jacket Material:

FEP

Jacket Diameter:

(1.42 mm) .056" dia.

Bend Radius:

5 mm

Mates with:
SMA, RSP-122811-01

A Samtec original solution:
U.FL compatible plug to 500 cycles (HMHF1)

MATING SOLUTION

- Micro RF PCB connectors for Micro High Frequency RFs
- MHF1 end mates with RSP-122811-01 (Cycles: 30 max.)

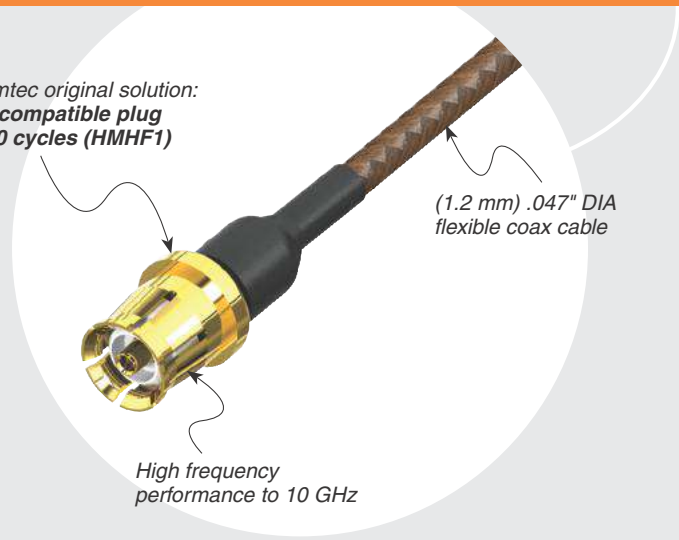
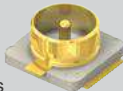

CABLE TYPE

RF047
= (1.2 mm) .047" DIA
28 AWG Flexible coax cable

END 1 CONNECTOR

Specify END OPTIONS from chart

END 2 CONNECTOR

OVERALL LENGTH

– “XXXX”
= Overall Length in millimeters
–0100 (100 mm) 3.94" minimum

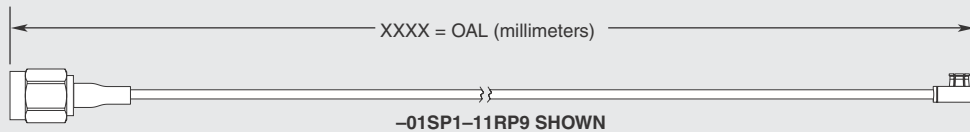

ALSO AVAILABLE (MOQ Required)

- Additional stripping and tinning options
- Contact Samtec.

OTHER SOLUTIONS

- Cable connector kits (see cable components catalog pages)

END OPTIONS

| | |
|--|--|
| <p>–01SP1 = SMA Straight Plug (30 μ" (0.76 μm) Gold on Center Contact, Gold Flash on Shell)</p> | |
| <p>–11SP9 = HMHF1 U.FL Straight Plug (30 μ" (0.76 μm) Gold on Center Contact, Gold Flash on Shell)</p> | |
| <p>–11RP9 = HMHF1 U.FL Right-angle Plug (30 μ" (0.76 μm) Gold on Center Contact, Gold Flash on Shell)</p> | |
| <p>–SING = Single Ended (End 2 Callout)</p> | |
| <p>–XXXXXX = Stripped & Tinned (End 2 Callout)</p> | |

STRIPPED & TINNED (Dimensions in mm)

| CALLOUT | A | B | C |
|---------|-----|-----|-----|
| –303030 | 3.0 | 3.0 | 3.0 |
| –303040 | 3.0 | 3.0 | 4.0 |
| –403030 | 4.0 | 3.0 | 3.0 |
| –403040 | 4.0 | 3.0 | 4.0 |
| –404040 | 4.0 | 4.0 | 4.0 |

Both center conductor and braid shield are stripped, only the center conductor is tinned.

MMCX7-J-P-GF-RA-TH1



MMCX7-J-P-GF-ST-TH1



MMCX7-P-P-GF-ST-TH1

MMCX7 SERIES

75 Ω MICRO-MINI SYSTEMS

SPECIFICATIONS

For complete specifications and recommended PCB layouts see www.samtec.com?MMCX7-TH

- Shell Material:** Brass
- Insulator Material:** PTFE
- Contact Material:** BeCu
- Pin Material:** Brass
- Operating Temp Range:** -65 °C to +125 °C
- Impedance:** 75 Ω
- Dielectric Withstanding Voltage:** 500 Vrms, 50 Hz
- Dielectric Working Voltage:** 170 Vrms, 50 Hz
- Frequency Range:** 0-6 GHz
- RoHS Compliant:** Yes

PROCESSING

Lead-Free Solderable: Yes

MMCX7

GENDER

TYPE

PLATING

ORIENTATION

TERMINATION

Mates with:
MMCX7-P, RF179,
GRF7H-C

-J
= Jack

-P
= PCB Mount

-GF
= 10 μ" (0.25 μm) Gold center contact,
3 μ" (0.08 μm) Gold outer contact

-RA
= Right-angle

-ST
= Straight

-TH1
= Through-hole

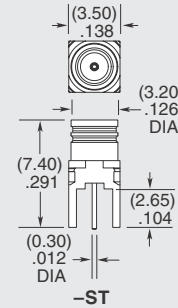
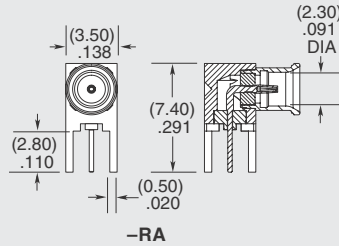

OTHER SOLUTIONS

- 75 Ω Cable Components available
- Contact Samtec.

MMCX7

GENDER

TYPE

PLATING

ST

TH1

Mates with:
MMCX7-J, RF179,
GRF7H-C

-P
= Plug

-GF
= 10 μ" (0.25 μm) Gold center contact,
3 μ" (0.08 μm) Gold outer contact

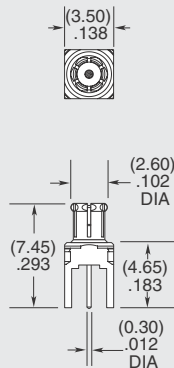

Due to technical progress, all designs, specifications and components are subject to change without notice.

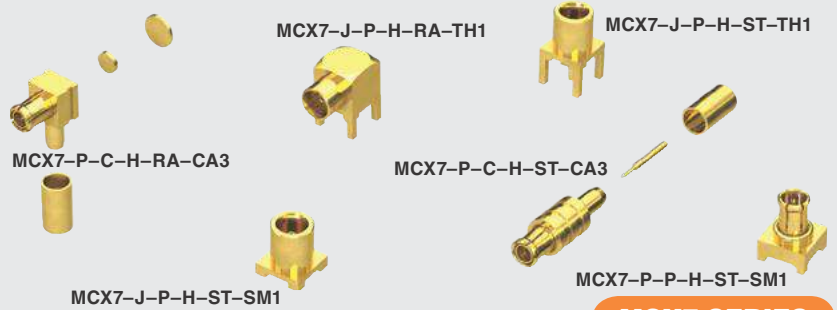

MCX7 SERIES

75 Ω OPTIMIZED MCX JACKS & PLUGS

SPECIFICATIONS

For complete specifications and recommended PCB layouts see www.samtec.com?MCX7-SM or www.samtec.com?MCX7-TH

- Shell Material:** Brass
- Contact Material:** BeCu
- Insulator Material:** PTFE
- Impedance:** ST = 75 Ω ±3 Ω
RA = 75 Ω ±4 Ω
- Frequency Range:** 0-6 GHz
- Working Voltage:** 170 Vrms max
- Dielectric Withstanding:** 500 Vrms min
- Engagement Force:** 4.5 lbs max (-ST only)
- Disengagement Force:** 2.3 lbs max (-ST only)
- Operating Temperature:** -65 °C to +125 °C
- RoHS Compliant:** Yes

PROCESSING

Lead-Free Solderable: Yes

| MCX7 | GENDER | TYPE | PLATING | ORIENTATION | TERMINATION |
|------|------------------------------|-------------------|---|---|--|
| | -P = Plug -J = Jack | -P = PCB Mount | -H = 30 μ" (0.76 μm) Gold center contact, 3 μ" (0.08 μm) Gold outer contact | -ST = Straight -RA = Right-angle (-J-TH1 only) | -SM1 = Surface Mount (-ST only) -TH1 = Through-hole (-J only) |
| | | | | | |
| | | | | | |

SPECIFICATIONS

For complete specifications and assembly instructions see www.samtec.com?MCX7-CA

- Contact Material:** Brass
- Finger Shell Material:** BeCu
- Body Material:** Brass
- Insulator Material:** PTFE
- Center Contact:** Soldered
- Outer Ferrule:** Crimped
- Impedance:** 75 Ω
- Frequency Range:** 0-6 GHz (-ST)
0-4.5 GHz (-RA)
- Working Voltage:** 170 Vrms max
- Dielectric Withstanding:** 500 Vrms min
- Operating Temperature:** -65 °C to +125 °C

| MCX7 | GENDER | TYPE | PLATING | ORIENTATION | TERMINATION |
|------|--------------|---------------|---|---|------------------------|
| | -P = Plug | -C = Cable | -H = 30 μ" (0.76 μm) Gold center contact, 3 μ" (0.08 μm) Gold outer contact | -ST = Straight -RA = Right-angle | -CA3 = RG 179 Cable |
| | | | | | |

Supplied with pins and ferrules. See website for dimensions.

Due to technical progress, all designs, specifications and components are subject to change without notice.



(4.00 mm) .1575"

IJ5C SERIES

50 Ω HIGH ISOLATION RF CABLE ASSEMBLY

SPECIFICATIONS

For complete specifications and recommended PCB layouts see www.samtec.com?IJ5C

Insulator Material: Black LCP

Contact Material: Copper Alloy

Pin Material: Copper Alloy

Dielectric Material: Black LCP

Plating: Au over 50 μ" (1.27 μm) Ni

Operating Temp Range: -40 °C to +90 °C

RoHS Compliant: Yes

Cable (-1):

Conductor Size: 26 AWG,

(0.48 mm) .019" dia.

Conductor Material: Silver Plated Copper

Insulator Diameter: (1.27 mm) .050"

Insulator Material: Foamed FEP

Shield Material: Silver Plated Copper

Jacket Material: FEP

Jacket Diameter: (1.80 mm) .071"

Bend Radius: 3.175 mm

Impedance: 50 Ω

Current Rating: 2.5 A

RoHS Compliant: Yes

Cable (-2):

Conductor Size: 26 AWG,

(0.51 mm) .020" dia.

Conductor Material: Silver and Copper

Insulator Diameter: (1.52 mm) .060"

Insulator Material: PTFE

Shield Material: Silver Plated Copper Wire

Jacket Material: FEP

Jacket Diameter: (2.54 mm) .100"

Bend Radius: 12.7 mm

Impedance: 50 Ω

Current Rating: 5 A DC

RoHS Compliant: Yes

RECOGNITIONS

For complete scope of recognitions see www.samtec.com/quality



Note: This Series is non-standard, non-returnable.

Mates with:
IP5

EDGE RATE®
CONTACT



- Edge Rate® Contacts
- Positive Latching

Single or Double Ended

High-performance 26 AWG coax cable

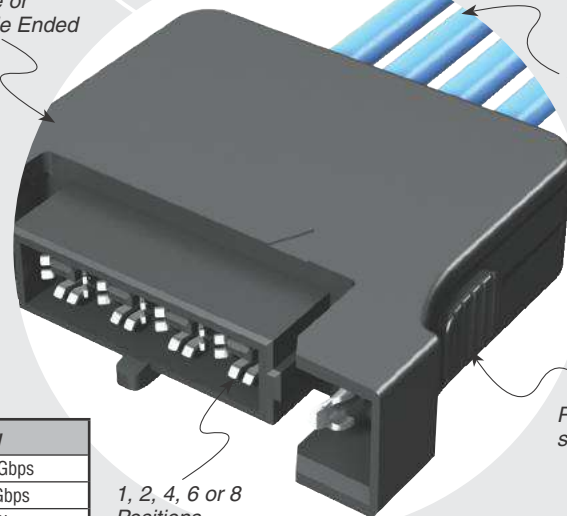

Positive latching system

1, 2, 4, 6 or 8 Positions

| 1 Meter Cable Assembly | Frequency |
|------------------------|---------------------|
| Insertion Loss = 3 dB | 9.5 GHz / 19.0 Gbps |
| Return Loss = 15 dB | 2.2 GHz / 4.4 Gbps |
| Isolation = 60 dB | 3.1 GHz / 6.2 Gbps |

Performance and complete test data available at www.samtec.com?IJ5C or contact sig@samtec.com

| IJ5C | NO. OF POSITIONS | ASSEMBLED LENGTH | PLATING OPTION | END OPTION | END 2 OPTION | CABLE TYPE |
|------|-------------------------|---|---|--|--|--|
| | -01, -02, -04, -06, -08 | - "XXXX" = Assembled Length in millimeters -0100 to -1000 (100 mm) 3.94" minimum | -S = 30 μ" (0.76 μm) Gold on contact | -S = Single Ended -D = Double Ended | -NUS = Notch up, straight P1 to P1 -NDS = Notch down, straight P1 to PN | -1 = CTB-2650F-01 cable -2 = RG 316 cable |

| NO. OF POSITIONS | A |
|------------------|---------------|
| -01 | (20.87) .822 |
| -02 | (24.87) .979 |
| -04 | (32.87) 1.294 |
| -06 | (40.87) 1.609 |
| -08 | (48.87) 1.924 |

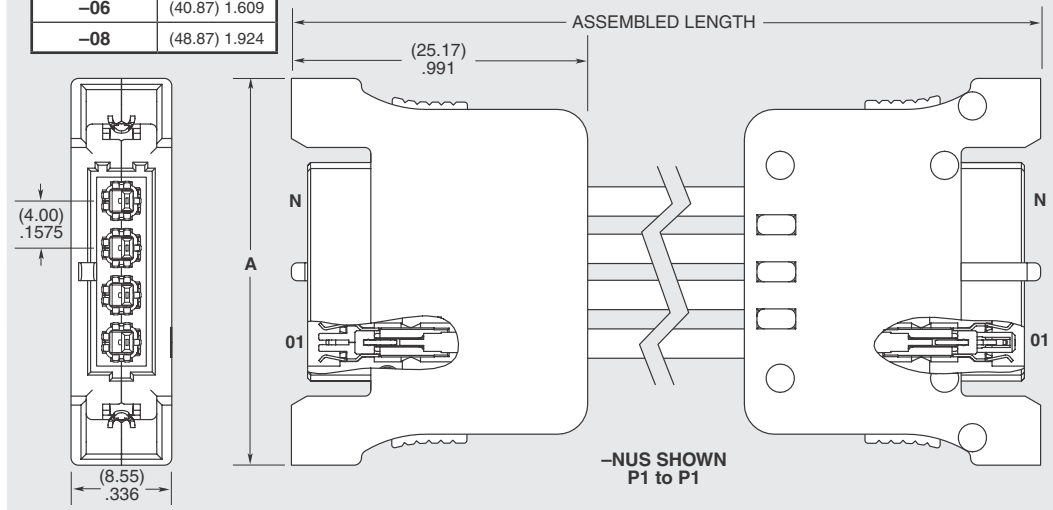

Due to technical progress, all designs, specifications and components are subject to change without notice.

WWW.SAMTEC.COM

All parts within this catalog are built to Samtec's specifications. Customer specific requirements must be approved by Samtec and identified in a Samtec customer-specific drawing to apply.



(4.00 mm) .1575"

50 Ω HYBRID RF CABLE ASSEMBLY

SPECIFICATIONS

For complete specifications and recommended PCB layouts see www.samtec.com?IJ5H

Insulator Material:

Black LCP

Contact Material:

Copper Alloy

Pin Material:

Copper Alloy

Dielectric Material:

Black LCP

Plating:

Au over 50 μ" (1.27 μm) Ni

Operating Temp Range:

-40 °C to +90 °C

RoHS Compliant:

Yes

Cable (-2):

Conductor Size:

26 AWG, (0.51 mm) .020" dia.

Conductor Material:

Silver and Copper

Insulator Diameter:

(1.52 mm) .060"

Insulator Material:

PTFE

Shield Material:

Silver Plated Copper Wire

Jacket Material:

FEP

Jacket Diameter:

(2.54 mm) .100"

Bend Radius:

12.7 mm

Impedance:

50 Ω

Current Rating:

5A DC

RoHS Compliant:

Yes

Mates with:
IP5, SMA, MCX, MMCX, SMB5

Low-cost isolated transmission line system

RG 316 Cable

1, 2, 4, 6 or 8 Positions

Positive latching

Choice of traditional RF end options

EDGE RATE
CONTACT

| IJ5H | NO. OF POSITIONS | ASSEMBLED LENGTH | END 1 PLATING | CABLE TYPE | END 2 OPTION | | | | | | | | | | |
|-----------------------------|-----------------------------|---|---|----------------------|---|----------|-------------------------|----------------------------|----------------------------|----------------------------|-----------------------------|-----------------------------|----------------------------|----------------------------|--|
| | -01, -02, -04, -06, -08 | - "XXXX" = Assembled Length in millimeters -0300 to -1000 (1000 mm) 39.40" maximum | -S = 30 μ" (0.76 μm) Gold on contact | -2 = RG 316 cable | <table border="1"> <tr> <td>All Gold</td> <td>Gold/Nickel combination</td> </tr> <tr> <td>-01SP1 = SMA Straight Plug</td> <td>-02SP2 = MCX Straight Plug</td> </tr> <tr> <td>-02SP1 = MCX Straight Plug</td> <td>-03SP2 = MMCX Straight Plug</td> </tr> <tr> <td>-03SP1 = MMCX Straight Plug</td> <td>-07SP2 = SMB Straight Plug</td> </tr> <tr> <td>-07SP1 = SMB Straight Plug</td> <td></td> </tr> </table> | All Gold | Gold/Nickel combination | -01SP1 = SMA Straight Plug | -02SP2 = MCX Straight Plug | -02SP1 = MCX Straight Plug | -03SP2 = MMCX Straight Plug | -03SP1 = MMCX Straight Plug | -07SP2 = SMB Straight Plug | -07SP1 = SMB Straight Plug | |
| All Gold | Gold/Nickel combination | | | | | | | | | | | | | | |
| -01SP1 = SMA Straight Plug | -02SP2 = MCX Straight Plug | | | | | | | | | | | | | | |
| -02SP1 = MCX Straight Plug | -03SP2 = MMCX Straight Plug | | | | | | | | | | | | | | |
| -03SP1 = MMCX Straight Plug | -07SP2 = SMB Straight Plug | | | | | | | | | | | | | | |
| -07SP1 = SMB Straight Plug | | | | | | | | | | | | | | | |

| NO. OF POSITIONS | A |
|------------------|---------------|
| -01 | (20.87) .822 |
| -02 | (24.87) .979 |
| -04 | (32.87) 1.294 |
| -06 | (40.87) 1.609 |
| -08 | (48.87) 1.924 |

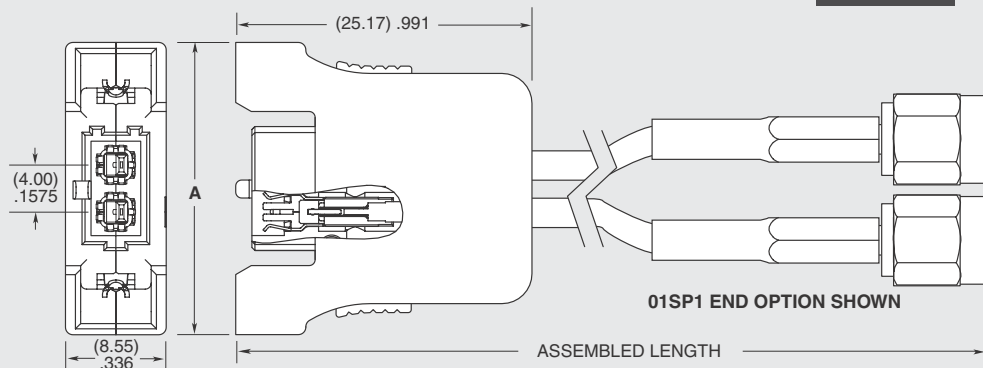

Note:
This Series is non-standard, non-returnable.

Due to technical progress, all designs, specifications and components are subject to change without notice.

WWW.SAMTEC.COM

All parts within this catalog are built to Samtec's specifications. Customer specific requirements must be approved by Samtec and identified in a Samtec customer-specific drawing to apply.

(4.00 mm) .1575"

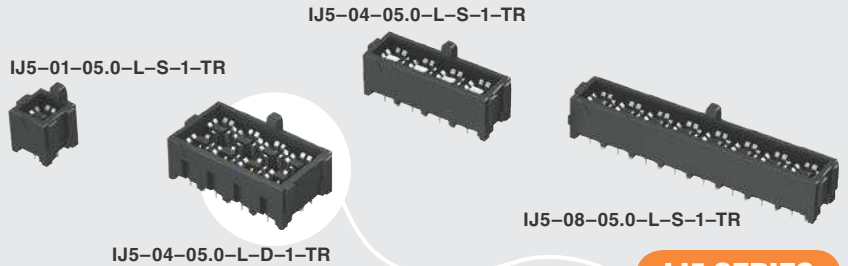

IJ5 SERIES

50 Ω HIGH ISOLATION RF JACKS

SPECIFICATIONS

For complete specifications and recommended PCB layouts see www.samtec.com/IJ5

Shell Material:

Copper Alloy

Insulator Material:

Black LCP

Contact Material:

Copper Alloy

Dielectric Material:

Black LCP

Plating:

Au or Sn over
50 μ" (1.27 μm) Ni

Current Rating (Vertical):

Signals: 2.36 A per pin
(2 adjacent pins powered)
Grounds: 4.4 A per pin
(2 adjacent pins powered)

Operating Temp Range:

-55 °C to +125 °C

Dielectric

Withstanding Voltage:

600 VAC

Working Voltage:

200 VAC

RoHS Compliant:

Yes

Mates with:

IP5

| IP5/IJ5 10 mm Stack Height | Frequency |
|-------------------------------|----------------------|
| Insertion Loss = 3 dB | 10.5 GHz / 21.0 Gbps |
| Return Loss = 15 dB | 5.5 GHz / 11.0 Gbps |
| Isolation = 60 dB | 8.8 GHz / 17.6 Gbps |
| Isolation = 70 dB | 7.6 GHz / 15.2 Gbps |
| Isolation = 80 dB | 1.3 GHz / 2.6 Gbps |

Complete test data available at www.samtec.com/IJ5 or contact sig@samtec.com

Single or
Double Row

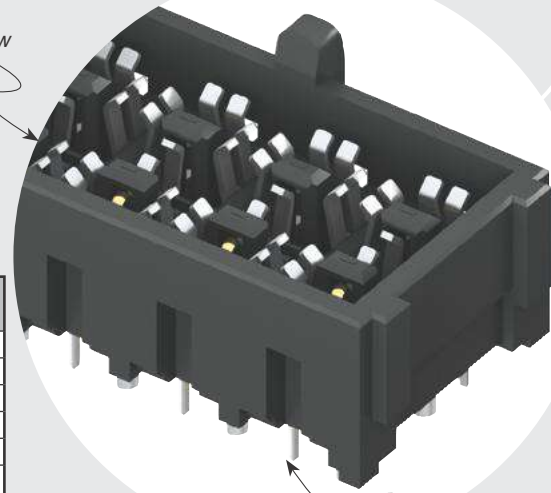

1, 2, 4, 6 or 8
Positions

PROCESSING

Lead-Free Solderable:
Yes

RECOGNITIONS

For complete scope of recognitions see www.samtec.com/quality



FILE NO. E111594

ALSO AVAILABLE (MOQ Required)

- Other stack heights
 - Other PCB thicknesses
- Contact Samtec.

OTHER SOLUTIONS

- Cable assembly (see IJ5C Series)

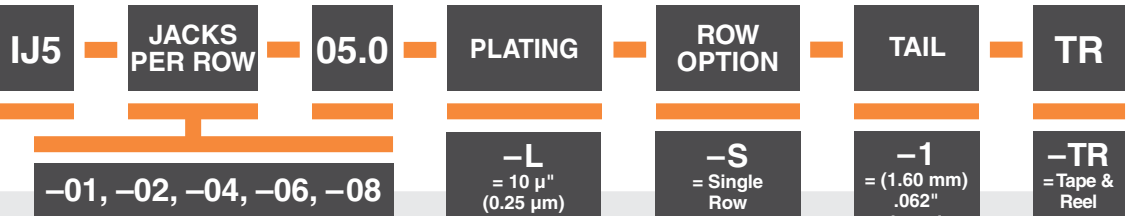

-01, -02, -04, -06, -08

-L
= 10 μ" (0.25 μm)
Gold on contact area,
Matte Tin on tail

-S
= Single Row

-D
= Double Row
(Not available with -01)

-1
= (1.60 mm) .062" board thickness

-TR
= Tape & Reel

| NO. OF JACKS | A |
|--------------|------------------|
| -01 | (5.55) .219 |
| -02 | (9.55) .376 |
| -04 | (17.55) .691 |
| -06 | (25.55) 1.006 |
| -08 | (33.55) 1.321 |

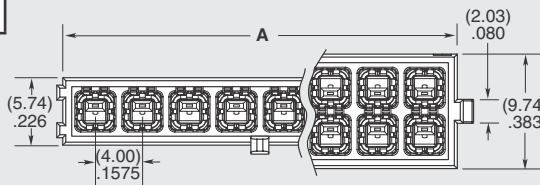

APPLICATION

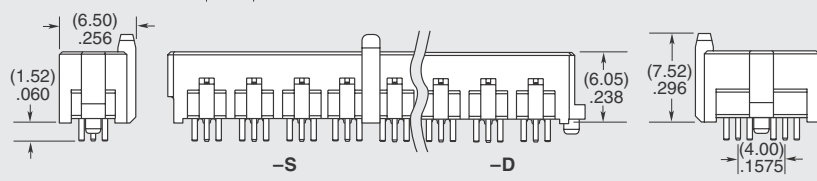
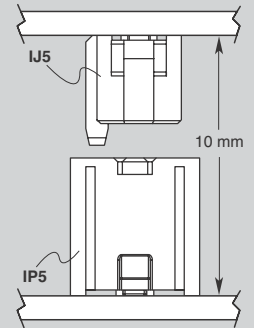

Due to technical progress, all designs, specifications and components are subject to change without notice.



(4.00 mm) .1575"

IP5, IP5-RA SERIES

50 Ω HIGH ISOLATION RF PLUGS

SPECIFICATIONS

For complete specifications and recommended PCB layouts see www.samtec.com?IP5

Shell Material:

Copper Alloy
Insulator Material:
Black LCP

Contact Material:

Copper Alloy
Dielectric Material:
Black LCP

Plating:

Au or Sn over
50 μ" (1.27 μm) Ni

Current Rating (Vertical):

Signals: 2.36 A per pin
(2 adjacent pins powered)
Grounds: 4.4 A per pin
(2 adjacent pins powered)

Operating Temp Range:

-55 °C to +125 °C

Dielectric Withstanding Voltage:

IP5 = 600 VAC
IP5-RA = 190 VAC
Working Voltage:
IP5 = 200 VAC
IP5-RA = 190 VAC
RoHS Compliant:
Yes

| | | | | | | | |
|-----------------------|----------------------|--------------------------------|--|--|--|---|-----------------------------|
| IP5 | PLUGS PER ROW | 05.0 | PLATING | ROW OPTION | TAIL | OPTION | TR |
| Mates with: IJ5, IJ5C | | -01, -02, -04, -06, -08 | -L = 10 μ" (0.25 μm) Gold on contact area, Matte Tin on tail | -S = Single Row -D = Double Row (Not available with -01) | -1 = (1.60 mm) .062" board thickness | -L = Cable Latch (Single Row only) | -TR = Tape & Reel |

| IP5/IJ5 10 mm Stack Height | Frequency |
|----------------------------|----------------------|
| Insertion Loss = 3 dB | 10.5 GHz / 21.0 Gbps |
| Return Loss = 15 dB | 5.5 GHz / 11.0 Gbps |
| Isolation = 60 dB | 8.8 GHz / 17.6 Gbps |
| Isolation = 70 dB | 7.6 GHz / 15.2 Gbps |
| Isolation = 80 dB | 1.3 GHz / 2.6 Gbps |

Complete test data available at www.samtec.com?IP5 or contact sig@samtec.com

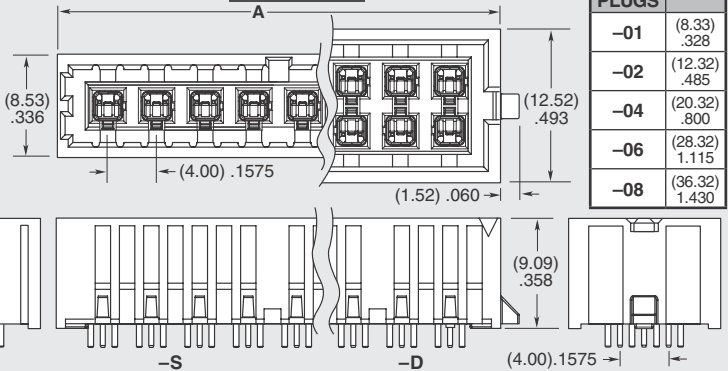

| NO. OF PLUGS | A |
|--------------|---------------|
| -01 | (8.33) .328 |
| -02 | (12.32) .485 |
| -04 | (20.32) .800 |
| -06 | (28.32) 1.115 |
| -08 | (36.32) 1.430 |

PROCESSING

Lead-Free Solderable:
Yes

RECOGNITIONS

For complete scope of recognitions see www.samtec.com/quality



FILE NO. E111594

ALSO AVAILABLE (MOQ Required)

- Other stack heights
 - Other PCB thicknesses
- Contact Samtec.

| | | | | | | | |
|-----------------------|----------------------|---------------------------|---|--|----------------------------------|----------------------------|-----------------------------|
| IP5 | PLUGS PER ROW | 01 | PLATING | S | TAIL OPTION | OPTION | TR |
| Mates with: IJ5, IJ5C | | -02, -04, -06, -08 | -L = 10 μ" (0.25 μm) Gold on contact area, Matte Tin on grounds, tails & weld tabs | -RA1 = (1.60 mm) .062" board thickness | (Leave blank for no Cable Latch) | -L = Cable Latch | -TR = Tape & Reel |

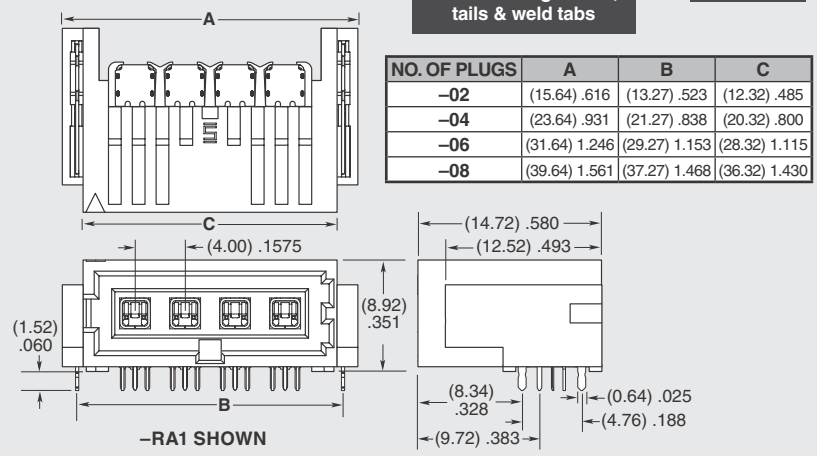

| NO. OF PLUGS | A | B | C |
|--------------|---------------|---------------|---------------|
| -02 | (15.64) .616 | (13.27) .523 | (12.32) .485 |
| -04 | (23.64) .931 | (21.27) .838 | (20.32) .800 |
| -06 | (31.64) 1.246 | (29.27) 1.153 | (28.32) 1.115 |
| -08 | (39.64) 1.561 | (37.27) 1.468 | (36.32) 1.430 |

APPLICATION

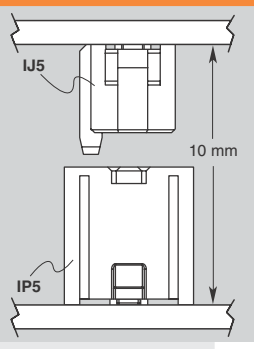

Due to technical progress, all designs, specifications and components are subject to change without notice.

CUSTOM RF SOLUTIONS

EXPRESS MODIFICATIONS

- Quick-turn prototype samples
- Short lead times
- Low or no Nonrecurring Engineering Charges (NREs)
- Low or no tooling charges

RF Board Level Interconnects

- Custom tail lengths
- Through-hole termination to surface mount or mixed technology
- Right-angle height adjustment from PCB
- Alternate plating options

RF Cable Assemblies

- Performance testing: VNA, TDR
- Custom labels and heat-shrink tubing
- Non-standard connector termination orientation
- Adding or removing bulkhead mounting
- Alternate plating options

ENGINEERED CUSTOMS

- Full engineering, design and prototype support from Samtec's RF Group
- Design, simulation and processing assistance
- Flexible, quick-turn manufacturing
- Dedicated engineers and technicians for application specific RF products

RF Board Level Interconnects

- Completely customized to your specifications

RF Cable Assemblies

- Completely customized to your specifications
- Customized connector terminated to existing cable
- Customized cable terminated to existing connector

RF GROUP

- Personal support from Samtec's highly qualified, in-house staff of RF engineers
- Express modifications to standard products to complete engineering, design and prototype support
- Design, simulation and processing assistance
- Dedicated engineers and technicians for application specific RF products
- Contact RFTechnicalGroup@samtec.com



INDEX

*New products highlighted in bold.



Substitute impedance-matched connectors/cables

Bulls Eye® with custom end

Drop-in edge mount on any RF connector

Engineered custom cable adaptors

Non-standard connector orientation

Quick-turn through-hole termination change

| Series | Description | Page |
|--------------|--|--------------|
| 292 | 50 Ω Precision 2.92 mm Jacks | 42 |
| 292-CA | 50 Ω Precision 2.92 mm Cable Components | 43 |
| BDR | Replacement block for 20 GHz Bulls Eye® (BDRA) | 20 |
| BDRA | 20 GHz Bulls Eye® Assembly: Double Row | 18 |
| BE23S | Replacement cable for 20 GHz Bulls Eye® (BDRA, BQRA) | 20 |
| BE40A | 50 GHz Bulls Eye® Assembly: Double Row | 17 |
| BE40B | Replacement block for 50 GHz Bulls Eye® (BE40A) | 20 |
| BE40C | Replacement cable for 50 GHz Bulls Eye® (BE40A) | 20 |
| BNC5-CA | 50 Ω BNC Cable Components | 52 |
| BNC7T | 75 Ω, 12G-SDI BNC Jacks | 58-59 |
| BNC7T-CA | 75 Ω, 12G-SDI BNC Cable Components | 58-59 |
| BQR | Replacement block for 20 GHz Bulls Eye® (BQRA) | 20 |
| BQRA | 20 GHz Bulls Eye® Assembly: Quad Row | 19 |
| C28S | 100 Ω Shielded Twisted Pair Twinax Cable Assembly | 62 |
| CJT | 100 Ω Twinax Jack, Through-hole & Bulkhead Through-hole | 63 |
| DIN7A | 75 Ω, 12G-SDI DIN 1.0/2.3 Jacks | 55 |
| DIN7A-CA | 75 Ω, 12G-SDI DIN 1.0/2.3 Cable Components | 55 |
| GRF1-C | 5.00 mm 50 Ω Ganged Micro-Mini RF Plug, Cable | 65 |
| GRF1H-C | 5.00 mm 50 Ω Ganged Hybrid Micro-Mini RF Cable | 66-67 |
| GRF1-J | 5.00 mm 50 Ω Ganged Micro-Mini RF Jack, PCB Mount | 64 |
| GRF1-P | 5.00 mm 50 Ω Ganged Micro-Mini RF Plug, PCB Mount | 64 |
| GRF7H-C | 5.00 mm 75 Ω Ganged Hybrid Micro-Mini RF Cable | 68-69 |
| GRF7-J | 5.00 mm 75 Ω Ganged Micro-Mini RF Jack, PCB Mount | 70 |
| GRF7-P | 5.00 mm 75 Ω Ganged Micro-Mini RF Plug, PCB Mount | 70 |
| HDBNC | 75 Ω, 12G-SDI High-Density BNC Jacks | 56 |
| HDBNC-CA | 75 Ω, 12G-SDI High-Density BNC Cable Components | 57 |
| IJ5 | 4.00 mm IsoRate® 50 Ω High Isolation RF Jack Strip | 76 |
| IJ5C | 4.00 mm IsoRate® 50 Ω High Isolation RF Cable | 74 |
| IJ5H | 4.00 mm IsoRate® 50 Ω High Isolation Hybrid RF Cable | 75 |
| IP5 | 4.00 mm IsoRate® 50 Ω High Isolation RF Plug Strip | 77 |
| MCX | 50 Ω MCX Jacks & Plugs | 50 |
| MCX7 | 75 Ω MCX Jacks & Plugs | 73 |
| MCX7-CA | 75 Ω MCX Cable Components | 73 |
| MCX-CA | 50 Ω MCX Cable Components | 51 |
| MH081 | Micro High Frequency RF Cable Assembly, 0.81 mm Diameter | 22 |
| MH113 | Micro High Frequency RF Cable Assembly, 1.13 mm Diameter | 23 |
| MMCX | 50 Ω MMCX Jacks & Plugs | 49 |
| MMCX7 | 75 Ω Micro-Mini Jacks & Plugs | 72 |
| MMCX-CA | 50 Ω MMCX Cable Components | 51 |
| MMCX-SW | 50 Ω MMCX Switchable Jack | 49 |
| NTPE-CA | N Type Jack Cable Components | 53 |
| RF047 | 50 Ω Flexible RF Cable Assembly, (.047" DIA) 28 AWG | 71 |
| RF058 | 50 Ω RF Cable Assembly, RG 58 Cable | 31 |
| RF174 | 50 Ω RF Cable Assembly, RG 174 Cable | 24-25 |
| RF178 | 50 Ω RF Cable Assembly, RG 178 Cable | 26-27 |
| RF179 | 75 Ω RF Cable Assembly, RG 179 Cable | 38-39 |
| RF23C | 50 Ω Cable Assembly, 23 AWG Solid Dielectric with Copper Shield | 34-35 |
| RF23S | 50 Ω Cable Assembly, 23 AWG Solid Dielectric | 36 |
| RF25S | 50 Ω Cable Assembly, 25 AWG Solid Dielectric | 36 |
| RF316 | 50 Ω RF Cable Assembly, RG 316 Cable | 28-29 |
| RF402 | 50 Ω Semi-Flexible RF Cable Assembly, (.141" DIA) 19 AWG | 33 |
| RF405 | 50 Ω Semi-Flexible RF Cable Assembly, (.086" DIA) 24 AWG | 32 |
| RFA6T | 75 Ω RF Cable Assembly, RG 6 Cable | 37 |
| RFB6T | 75 Ω RF Cable Assembly, 1694A Cable | 37 |
| RFB8T | 75 Ω RF Cable Assembly, 1855A Cable | 40 |
| RS316 | 50 Ω RF Cable Assembly, Double-Shielded RG 316 Cable | 30 |
| SMA | 50 Ω SMA Jacks | 44-45 |
| SMA-CA | 50 Ω SMA Cable Components | 46 |
| SMB5 | 50 Ω SMB Jacks | 48 |
| SMB5-CA | 50 Ω SMB Cable Components | 48 |
| SMB7H | 75 Ω SMB Jacks | 60 |
| SMB7H-CA | 75 Ω SMB Cable Components | 60 |
| SMP | 50 Ω SMP Jacks/Plugs & Adaptor | 47 |
| SMP-CA | 50 Ω SMP Cable Components | 47 |
| TNC | 50 Ω TNC Jacks | 54 |
| TNC-CA | 50 Ω TNC Cable Components | 54 |

GENERAL POLICY

The information contained in this catalog is accurate to the best of our knowledge. Due to technical progress, it is subject to change without notice. Application information is informational in nature and shall not be construed to warrant suitability of products for any particular purpose as performance may vary with the conditions encountered. Any cut strip or custom made items or options are considered "special," non-returnable items. Samtec products are warranted for 30 days and the warranty is limited strictly to replacement of products with defective workmanship.

Federal Supply Code: 55322



samtec

SUDDEN SERVICE®

SAMTEC USA

P.O. Box 1147 • New Albany, IN 47151-1147 USA
+1-800-SAMTEC-9 (+1-800-726-8329) USA & Canada
Tel: +1-812-944-6733 • Fax: +1-812-948-5047
Email: info@samtec.com

SAMTEC NORTHERN CALIFORNIA

2323 Owen St., Ste 120 • Santa Clara, CA 95054
+1-800-726-8329 (USA & Canada)
Tel: +1-812-944-6733 • Fax: +1-408-217-5171
Email: samtecsiliconvalley@samtec.com

SAMTEC SOUTHERN CALIFORNIA

5410 Trabuco Road • Suite 120 • Irvine, CA 92620
Tel: +1-800-726-8329
Email: samtecsoutherncalifornia@samtec.com

SAMTEC SOUTH AMERICA

Rua Alagoas Nr 1460 • Sala 805 • Bairro Savassi
Belo Horizonte - Minas Gerais 30130-160 • Brazil
Tel: +55 31 9 9146 4447
Email: brazilsales@samtec.com

SAMTEC UNITED KINGDOM

11 Mollins Court • Westfield, Cumbernauld
Scotland G68 9HP
Tel: +44 01236 739292 • Fax: +44 01236 727113
Email: scotland@samtec.com

SAMTEC GERMANY

Streiflacher Str. 7 • 82110 Germering • Germany
+0800 SAMTEC9 (+0800 / 72 68 329) Germany only
Tel: +49 (0) 89 / 89460-0 • Fax: +49 (0) 89 / 89460-299
Email: germany@samtec.com

SAMTEC FRANCE

Val d' Europe Park • 11, rue du Courtaulin - Bâtiment B
77700 Magny le Hongre • France
Tel: +33 1 60 95 06 60 • Fax: +33 1 60 95 06 61
Email: france@samtec.com

SAMTEC ITALY

Via Colleoni 25 • Centro Direzionale Colleoni
Palazzo Pegaso Ingresso 3
20864 Agrate Brianza-Monza Brianza (MB) • Italy
Tel: +39 039 6890337 • Fax: +39 039 6890315
Email: italy@samtec.com

SAMTEC NORDIC/BALTIC

Solkraftsvägen 25 • 13570 Stockholm • Sweden
Tel: +46 8 4477280 • Fax: +46 8 7420413
Email: scandinavia@samtec.com

SAMTEC BENELUX

11 Mollins Court • Westfield, Cumbernauld
Scotland G68 9HP
Tel: +44 01236 739292 • Fax: +44 01236 727113
Email: benelux@samtec.com

SAMTEC ISRAEL

21 Bar-Kochva St. • Concord Tower
B'nei Brak, Israel 51260
Tel: +972 3 7526600 • Fax: +972 3 7526690
Email: israel@samtec.com

SAMTEC INDIA

#11, 2nd Floor, Chetana, Dattatreya Road
Basavanagudi • Bangalore • 560 004 India
Tel: +91 80 3272 1612 • Fax: +91 80 2662 0967
Email: india@samtec.com

SAMTEC ANZ

2A San Antonio Court • Mentone 3194
Victoria, Australia
Tel: +613 9580 0683 • Fax: +613 9580 0684
Email: australia@samtec.com

SAMTEC SINGAPORE

1 Kallang Sector #05-01/02 • Kollam Ayer Industrial Park
Singapore 349276
Tel: +65 6745 5955 • Fax: +65 6841 1502
Email: singapore@samtec.com

SAMTEC JAPAN

Nisso No. 16 Bldg. • 3-8-8, Shinyokohama, Kohoku-ku
Yokohama-shi, Kanagawa 222-0033 Japan
Tel: +81 45 475 1385 • Fax: +81 45 475 1340
Email: japan@samtec.com

SAMTEC SHANGHAI

Unit 601, Qilai Building • No 889 Yishan Road
Shanghai, China 200233
Tel: +86 21 6083 3766 • Fax: +86 21 5423 4575
Email: china@samtec.com

SAMTEC SHENZHEN

Rm 906B 9/F New World Center Tower
Yi Tian Road, Fu Tian District • Shenzhen, China 518026
Tel: +86 755 83776780 • Fax: +86 755 83776767
Email: hongkong@samtec.com

SAMTEC TAIWAN

Room D, Floor B1, No. 205, Sec. 3 • Beixin Rd.
Xindian District • New Taipei City 23143 • Taiwan
Tel: +886 2 7727 4060 • Fax: +886 2 7727 4179
Email: taiwan@samtec.com

SAMTEC HONG KONG

Room 18, 13/F, Shatin Galleria • 18-24 Shan Mei Street
Fo Tan, Shatin, Hong Kong
Tel: +852 26904858 • Fax: +852 26904842
Email: hongkong@samtec.com

SAMTEC KOREA

RM#705, 109 Gwanggyo-ro
Yeongtong-gu, Suwon-si, Gyeonggi-Do
16229 South Korea
Tel: +82 31 717 5685 • Fax: +82 70 7500 0246
Email: korea@samtec.com

SAMTEC ONLINE

www.samtec.com