



 BRADY®

M410

LABEL PRINTER

25 mm wide labels
One tough labeller

YOUR TOUGHEST LABELLING JOBS JUST GOT A LOT EASIER

Specifically engineered for premium 25 mm printing, the M410 Label Printer is an everyday workhorse for contractors, datacom and electrical professionals. Create and print labels faster with its intuitive QWERTY keypad and programmed pre-set label options for wire marking, flagging and breaker box identification.

THE M410 LABEL PRINTER

Power through whatever the job throws at you

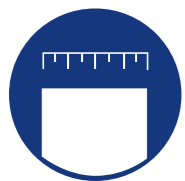

25 mm wide labels



Super intuitive keypad



Flexibility for any jobsite



▶ Learn more at bradyeurope.com/M410
Click or scan to watch the overview video



DESIGNED TO HANDLE WHATEVER YOUR WORK DEMANDS

Power through whatever the job throws at you with the M410. From easy-to-use onboard menu options to auto label setup with edge-to-edge printing, it's jobsite ready to take on your most demanding work. Ultra durable, it withstands everyday drops up to 1.2 m, and has time-saving shortcuts so you can do more in less time. Create labels with the intuitive keypad, customise design templates and choose from more material options. With more ways to get work done, the M410 outperforms your every expectation.



Withstands 1.2 m drops

Auto-formatting of text to label size

Intuitive QWERTY Keypad

Large window on cover-door shows installed cartridge

Less than 1.6 mm of label waste per job

Rubber overmolding improves durability and grip



A Upload and go
Import data through the USB port



B Faster changeovers
Simple all-in-one, drop-in cartridges



C Fit for many applications
Pre-sized and continuous labels (6.4 to 25 mm width)



D Label design guides
Reduce errors and save time with intuitive guides



M410 accessory

Utility hook

More time-saving tools to get the job done. See page 31

SIMPLY INTUITIVE SUPER TOUGH

More materials, more sizes and more applications mean more ways to get work done. Take on your toughest jobs with the M410.

Rugged. Reliable. Ready for your work.



Durable, industrial design – withstands 1.2 m drops



Edge-to-edge printing – more room to fit the data you need with no label waste



Up to 25 mm wide labels – ready to wrap, sleeve, tag and flag

Flexible data entry options that work with you



Connect to Brady Workstation through USB 2.0 port (Type A and B)



Work at an accelerated pace with 440 onboard symbols and on-board label design guides



Design and print labels using the intuitive printer keypad or desktop software

Create identification the easy way with the M410 printer + software system. With it, you can design and print labels seamlessly – wherever and whenever you need them.



Barcodes and graphics



Label sequencing



Microsoft Excel data imports

Brady Workstation software:

- ▶ 20+ barcode types
- ▶ 85+ fonts
- ▶ 1,400+ symbols
- ▶ Label saving and sharing
- ▶ Accurate print preview
- ▶ Real-time printer status

Work the way your work demands



Printer keypad



Desktop software



On-board label design guides

Applications

Voice & datacom identification

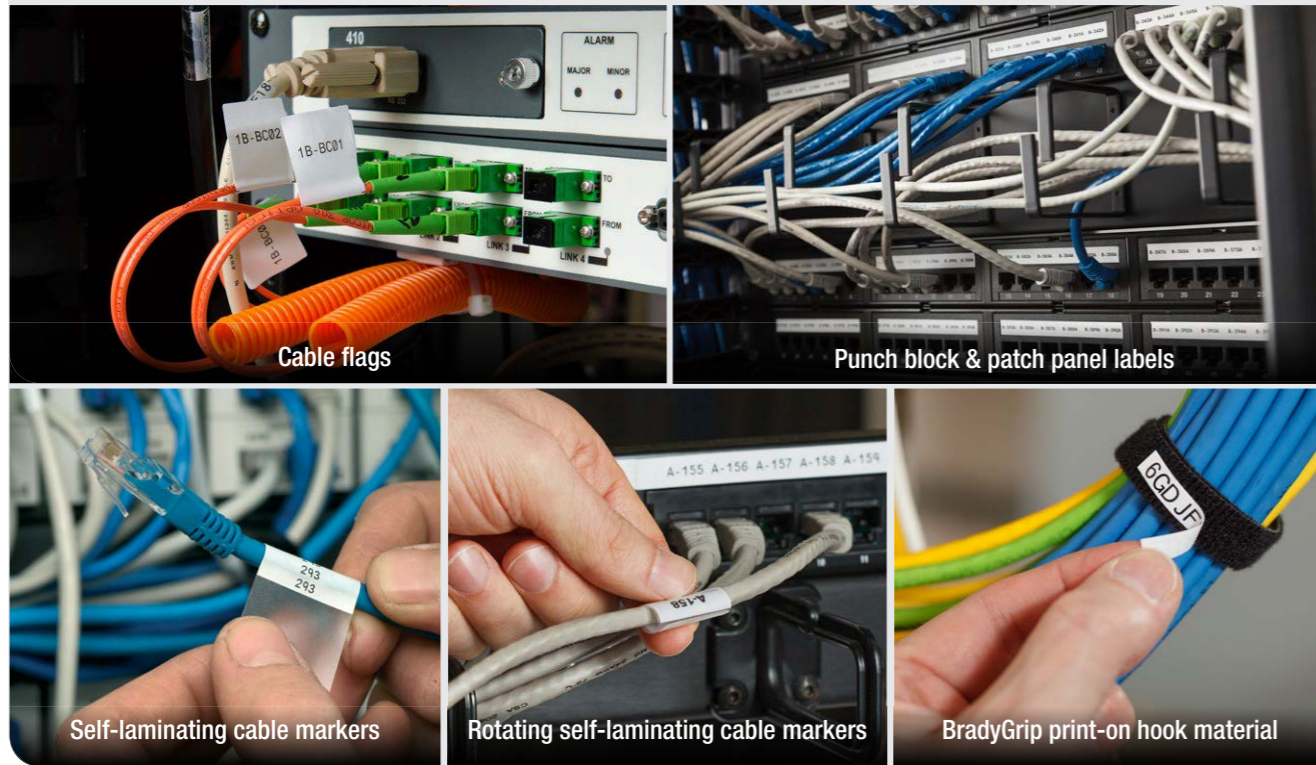

Electrical identification

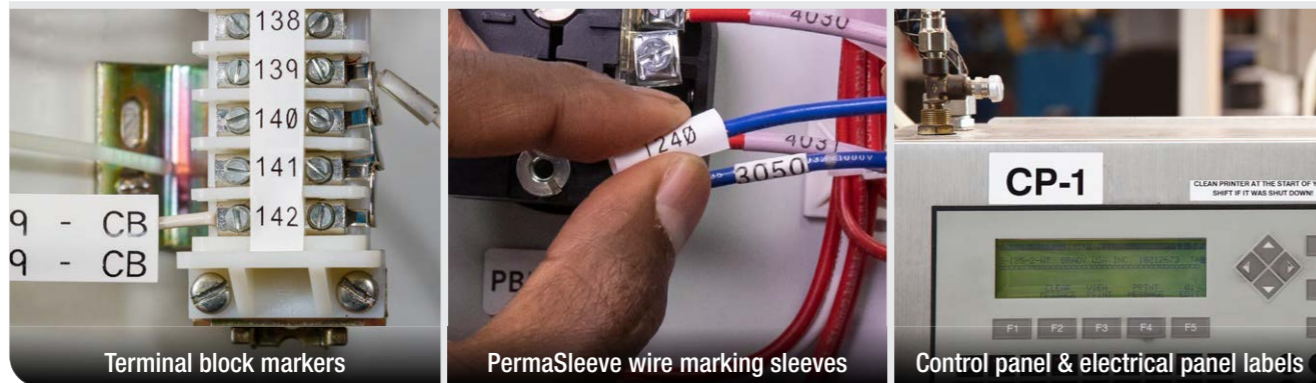

Applications

Facility & safety identification



Laboratory identification





Material overview

Material	Finish	Temp (°C) (Tested for 30 days)		Additional Features	Approval/Compliance
		Min.	Max.		
FreezerBondz™ Polyester					
B-490	Matt	-196 °C	130 °C	Can be applied to frozen surfaces including glass and polypropylene stored in liquid nitrogen, except for Vial Tops. Material must slightly overlap itself.	
B-492	Matt	-196 °C	110 °C	Ultra thin; can label frosted/frozen (with overlap) or room temperature labels and lasts in liquid nitrogen and hot water baths	
Heat-shrink Polyolefin					
B-342	Matt	-55 °C	130.6 °C	3:1 ratio heat shrinkable wire marking sleeve that fits snugly around wires for identification and protection. Fade-resistant and flame retardant.	UL Recognised to UL224, SAE-AMS-DTL-23053/5 C (Class 1), SAE AS-81531
B-7641	Matt	-55 °C	105 °C	2:1 ratio heat shrinkable, zero halogen wire marking sleeves. The wire marking sleeves offer outstanding fire safety properties and minimal smoke emission. Also available in yellow.	BS-6853 (1999) Vehicle Category 1A; EN-45545-2, requirement 24, Vehicle Category HL3, Zero Halogen
Metallised Polyester					
B-428	Matt	-70 °C	120 °C	Thermal transfer printable metallised polyester with matt finish. Withstands solvents and variable temperatures. Excellent for serial and rating plate applications with name-plate quality and a metal-looking finish.	UL Recognised, CSA Accepted, AGA Approved, Halogen Free (DIN VDE 0472/part 815)
Nylon Cloth					
B-499	Matt	-40 °C	90 °C	Nylon cloth material with matt finish. The adhesive allows labelling in environments with heat, cold, oil and dirt. Also available in yellow.	UL Recognised, CSA Accepted, Halogen Free (DIN VDE 0472/part 815) Approvals are for White material only
Paper					
B-403	Matt	-70 °C	100 °C	White dissolvable paper. Dissolves completely in water leaving no adhesive residue, ideal for temporary labelling applications	
Polyester					
B-414	Matt	-40 °C	50 °C	Get a grip on your wire and cable identification – Brady and VELCRO® Brand have partnered to bring you BradyGrip™ Print-on Hook Material, an exclusive print-and-place material that can be easily applied, repositioned or removed.	
B-422	Gloss	-40 °C	100 °C	Designed to withstand solvent exposure. Used for component identification, barcoding, asset and inventory tracking.	UL Recognised, CSA Accepted
B-423	Gloss	-70 °C	110 °C	Widely used for component identification, barcoding, asset and inventory tracking.	UL Recognised, CSA Accepted, Halogen Free (DIN VDE 0472/part 815) Approvals are for White material only
B-430	Gloss	-70 °C	100 °C	Translucent, high performance polyester material with a glossy finish. Thermal transfer printable.	UL Recognised, CSA Accepted
B-483A	Gloss	-40 °C	120 °C	White polyester thermal transfer printable material with glossy finish and aggressive adhesive specifically designed for powder coated surfaces.	UL Recognised, CSA Accepted
B-488	Matt	-40 °C	145 °C	White polyester thermal transfer printable material, similar to B-423, but with matt finish. Widely used for component identification, barcoding, asset and inventory tracking.	
Polypropylene					
B-412	Matt	-40 °C	100 °C	White polypropylene tag material with matt finish. Offers high print legibility and high tensile strength.	
B-425A	Matt	-70 °C	80 °C	White polypropylene material stock with matt finish for thermal transfer printing or write-on applications. Excellent solvent resistance and print performance; not recommended for long-term outdoor use.	UL Recognised, CSA Accepted, Halogen Free (DIN VDE 0472/part 815)
B-7425	Matt	-80 °C	70 °C	White Polypropylene material. Ideal for laboratory identification such as vials, centrifuge tubes and test tubes. For freezer or liquid nitrogen applications, B-7425 must be applied prior to being frozen.	
Reflective Tape					
B-584	Gloss	-40 °C	70 °C	Suitable for outdoor use. Also available in silver and yellow.	
Self-laminating Polyester					
B-461	Matt	-196 °C	110 °C	Permanent adhesive; suitable for liquid nitrogen application if material is wrapped around itself, as in self-lamination; write-on capabilities. Temperature range increases to 121 °C when used in autoclave process	



Material overview

Material	Finish	Temp (°C) (Tested for 30 days)		Additional Features	Approval/Compliance
		Min.	Max.		
Self-laminating Vinyl					
B-417	Matt	-40 °C	70 °C	Keep your wire identification secure with this self-laminating marker with extra-strong adhesive. The extra-strong adhesive makes these markers ideal for small-diameter wires. Features a white printable area and a clear tail that wraps around the marker.	UL Recognised to UL969 Labelling and Marking Standard when printed with the Brady Series R4300 and R7950 ribbons. See UL files MH62024 for specific details. Brady customers should specify at purchase if they require UL Recognised B-417 labels. Brady sells both UL Recognised B-417 labels and non-approved labels depending on customer requirements
B-427	Matt	-40 °C	60 °C	Thermal transfer printable, self-laminating material. These labels have a printable area with a clear "tail" that wraps around the marker. The "tail" serves as overlaminates to protect the print. Superior resistance to abrasion, solvents, water, oil and dirt. Also available in grey, brown, green, yellow, blue, red, purple, orange.	UL Recognised to UL969 Labelling and Marking Standard when printed with the Brady Series R4300 and R6200 ribbons. See UL files MH17154 for specific details. Brady customers should specify at purchase if they require UL Recognised B-427 labels. Brady sells both UL Recognised B-427 labels and non-approved labels depending on customer requirements.
Vinyl					
B-581	Gloss	-40 °C	82 °C	Only indoor use, where frequent repositioning is required	
B-595	Gloss	-40 °C	82 °C	Durable, low-shrink vinyl with our most aggressive adhesive. Conforms to irregular, curved, rough and highly textured surfaces (painted cinder blocks, uneven wood, textured plastics, paper-jacketed pipes, powder-coated surfaces). Adheres to "difficult" low-surface energy items (PVC piping, blow-moulded equipment cases, ABS plastics, recycled plastics). Available in a wide range of colours.	BS 5609:1986 Section 2 and section 3
Vinyl Cloth					
B-498	Semi-gloss	-40 °C	80 °C	White vinyl cloth label material with glossy finish. The adhesive and cloth backing give excellent holding power, while being repositionable and removing cleanly.	UL Recognised

Enjoy a more premium labelling experience with optimised Brady Authentic materials

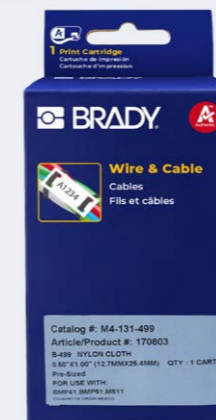

Authentic materials work seamlessly with Brady printers to produce enhanced performance and reliability you just don't get with materials from the "other guys." Get authentic. Get better with Brady.



THE RIGHT LABEL FROM THE RIGHT PARTNER

Voice & datacom identification

Data with durability

The M410 helps you power through work faster with 110+ hassle-free drop-in cartridges designed to handle whatever the job demands. Simple and intuitive, the M410 will keep pace as you wrap, sleeve, tag and flag your way through your most challenging work.

Your time- and cost-saving benefits include:



DECREASED SETUP TIME



FEWER LABEL ERRORS



COMPLIANT LABEL CREATION



REDUCED MATERIAL WASTE

Get the job done right on any jobsite

Optimise your performance with Brady materials



DATAKOM & TELECOM

- ▶ Keep compliant with protective self-lams and flags
- ▶ Convey more information printing edge to edge
- ▶ Communicate better with patch panel and faceplate ID



WIRE & CABLE, ELECTRICAL

- ▶ Use 1 tool for multiple on-site applications
- ▶ Create pre-set label options
- ▶ Wrap, sleeve, tag and flag through challenging work



GENERAL IDENTIFICATION

- ▶ Do more with a surplus of sizes, colours and materials
- ▶ Easily locate equipment, assets and batches
- ▶ Take on tough jobsites with purpose-built materials

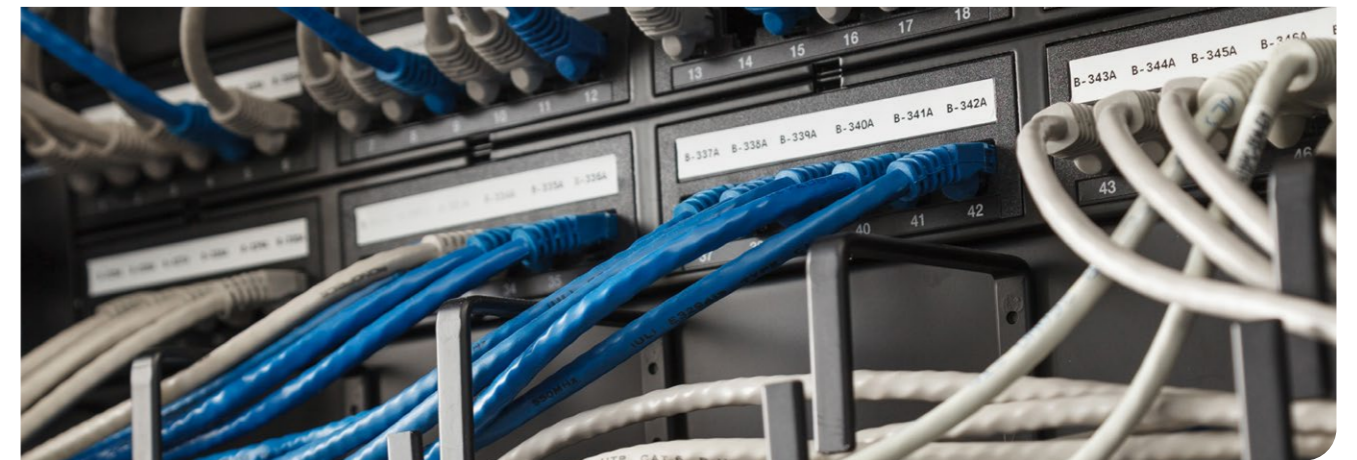

Router, server, faceplate, outlet and patch panel labels

Create the labels you need in one easy process. Create a fully-formatted serialised punch block label to fit your equipment or label your ports, jacks and outlets with adhesive labels or slide-in strips.

- Developed to withstand abrasion and low temperatures
- Designed to withstand exposure to numerous solvents
- High adhesion to textured metals, powder coated surfaces and low surface energy plastics

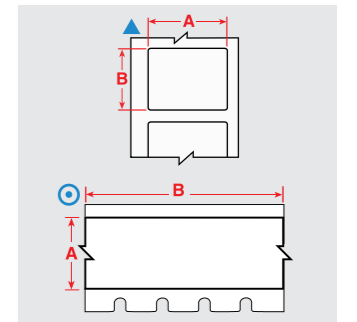

Diagram	Order Reference	Colour	Label Width A (mm)	Label Height B (mm)	Label Length B (m)	Labels per Roll	Additional Features
B-412: Polypropylene							
⊙	M4C-375-412	Black on White	9.53	-	6.10 m	1	Non-Adhesive Slide-in Strips
⊙	M4C-475-412	Black on White	12.07	-	6.10 m	1	Non-Adhesive Slide-in Strips
⊙	M4C-625-412	Black on White	15.88	-	6.10 m	1	Non-Adhesive Slide-in Strips
B-422: Polyester							
⊙	M4C-375-422	Black on White	9.53	-	7.62 m	1	Adhesive Stick-on Strips: Outlet, Patch Panel, Cont. Tape, Cut to Size
⊙	M4C-475-422	Black on White	12.07	-	7.62 m	1	Adhesive Stick-on Strips: Outlet, Patch Panel, Cont. Tape, Cut to Size
⊙	M4C-500-422	Black on White	12.70	-	7.62 m	1	Adhesive Stick-on Strips: Outlet, Patch Panel, Cont. Tape, Cut to Size
▲	M4-7-422	Black on White	12.70	12.70	-	280	Port Labels
⊙	M4C-625-422	Black on White	15.88	-	7.62 m	1	Adhesive Stick-on Strips: Outlet, Patch Panel, Cont. Tape, Cut to Size
▲	M4-47-422	Black on White	25.40	12.70	-	480	Adhesive Stick-on individual labels
B-423: Polyester							
⊙	M4C-1000-423	Black on White	25.40	-	7.62 m	1	Adhesive Stick-on Strips: Outlet, Patch Panel, Cont. Tape, Cut to Size
B-430: Polyester							
⊙	M4C-1000-430	Black on Transparent	25.40	-	7.62 m	1	Adhesive Stick-on Strips: Outlet, Patch Panel, Cont. Tape, Cut to Size
B-483A: Polyester							
▲	M4-47-483	Black on White	25.40	12.70	-	480	Ultra-aggressive adhesive; Designed for powder coated surfaces
B-595: Vinyl							
⊙	M4C-500-595-YL-BK	Black on Yellow	12.70	-	7.62 m	1	Adhesive Stick-on Strips, Cut to Size
⊙	M4C-500-595-CL-WT	White on Transparent	12.70	-	6.10 m	1	Adhesive Stick-on Strips, Cut to Size
⊙	M4C-750-595-CL-WT	White on Transparent	19.05	-	6.10 m	1	Adhesive Stick-on Strips, Cut to Size
⊙	M4C-750-595-YL-BK	Black on Yellow	19.05	-	7.62 m	1	Adhesive Stick-on Strips, Cut to Size



Enjoy a more premium labelling experience with optimised Brady Authentic materials

Authentic materials work seamlessly with Brady printers to produce enhanced performance and reliability you just don't get with materials from the "other guys." Get authentic. Get better with Brady.

▶ How to read an order reference: example M4-91-427-YL

M4 - **91** - **427** - **YL**
 M4: Die-cut label Label size code Brady material number Optional colour
 M4C: Continuous label (B-number)

Voice & datacom identification



Enjoy a more premium labelling experience with optimised Brady Authentic materials

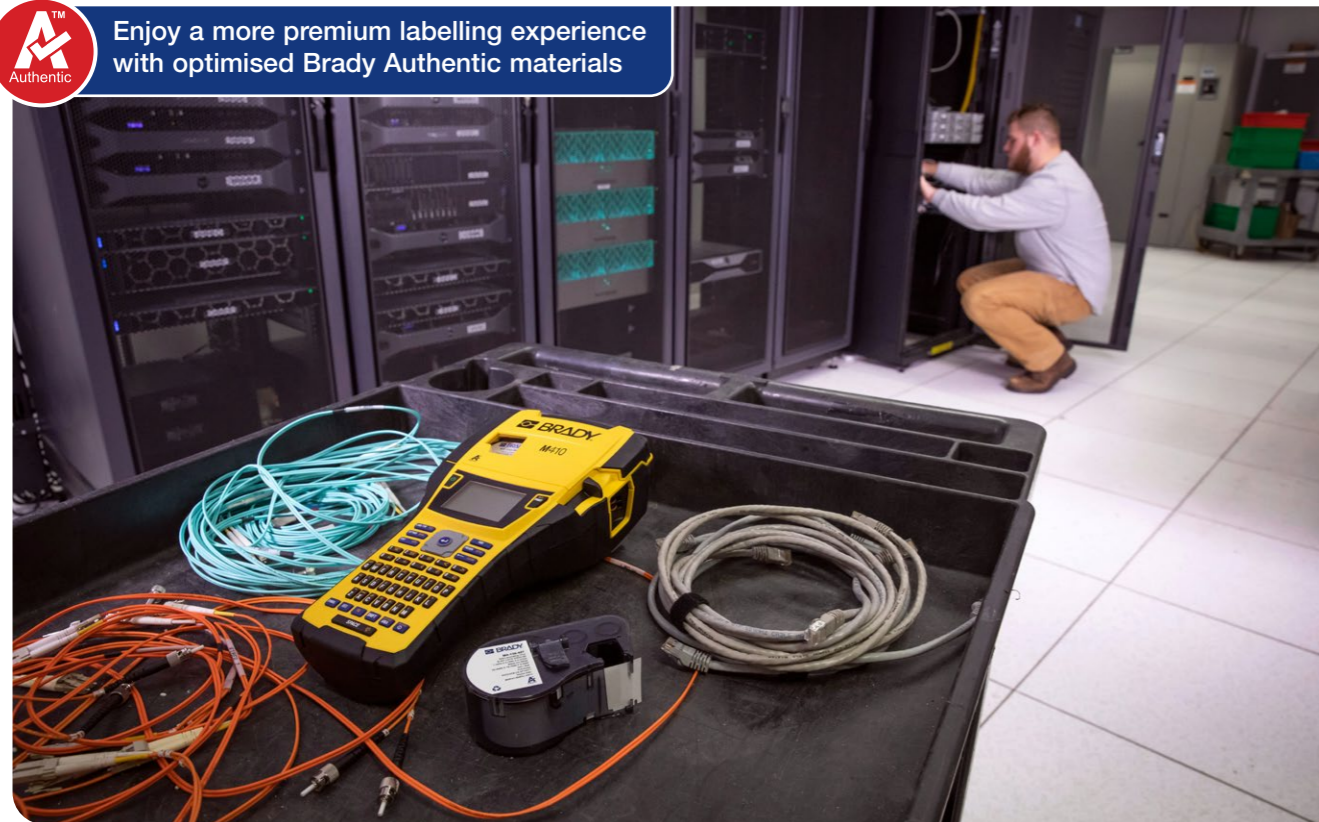

Closets, racks, frames and blocks labels

Durable materials, easy to slide in or stick on providing clearly legible identification to guarantee swift routine and non-routine maintenance as well as emergency repairs to keep the infrastructure running smoothly.

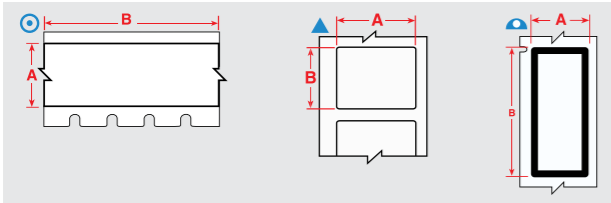

- Flexible with high-tack adhesives for easy and long-lasting adhesion
- Various sizes in several durable materials
- Rating plate labels offer a metal looking finish

Diagram	Order Reference	Colour	Label Width A (mm)	Label Height B (mm)	Label Length B (m)	Labels per Roll	Additional Features
B-422: Polyester							
▲	M4-89-422	Black on White	12.70	38.10	–	180	Adhesive Stick-on individual labels
▲	M4-90-422	Black on White	19.05	38.10	–	180	Adhesive Stick-on individual labels
⊙	M4C-1000-422	Black on White	25.40	–	7.62	1	Adhesive Stick-on Strips: Outlet, Patch Panel, Cont. Tape, Cut to Size
▲	M4-47-422	Black on White	25.40	12.70	–	480	Adhesive Stick-on individual labels
▲	M4-49-422	Black on White	25.40	25.40	–	260	Adhesive Stick-on individual labels
B-423: Polyester							
⊙	M4C-1000-423	Black on White	25.40	–	7.62	1	Adhesive Stick-on Strips: Outlet, Patch Panel, Cont. Tape, Cut to Size
B-428: Metallised Polyester							
▲	M4-92-428-BB	Black on Light Grey	12.70	28.70	–	239	Rating & Nameplate labelling with a metal looking finish
▲	M4-47-428	Black on Light Grey	25.40	12.70	–	480	Rating & Nameplate labelling with a metal looking finish
▲	M4-60-428	Black on Light Grey	25.40	50.80	–	140	Rating & Nameplate labelling with a metal looking finish
B-430: Polyester							
⊙	M4C-1000-430	Black on Transparent	25.40	–	7.62	1	Adhesive Stick-on Strips: Outlet, Patch Panel, Cont. Tape, Cut to Size
B-483A: Polyester							
▲	M4-61-483	Black on White	12.70	50.80	–	80	Ultra-aggressive adhesive; Designed for powder coated surfaces
▲	M4-60-483	Black on White	25.40	50.80	–	140	Ultra-aggressive adhesive; Designed for powder coated surfaces
B-595: Vinyl							
⊙	M4C-1000-595-YL-BK	Black on Yellow	25.40	–	7.62	1	Adhesive Stick-on Strips, Cut to Size
⊙	M4C-1000-595-OR-BK	Black on Orange	25.40	–	7.62	1	Adhesive Stick-on Strips, Cut to Size
⊙	M4C-1000-595-BL-WT	White on Blue	25.40	–	7.62	1	Adhesive Stick-on Strips, Cut to Size
⊙	M4C-1000-595-RD-WT	White on Red	25.40	–	7.62	1	Adhesive Stick-on Strips, Cut to Size
⊙	M4C-1000-595-CL-BK	Black on Transparent	25.40	–	6.10	1	Adhesive Stick-on Strips, Cut to Size
⊙	M4C-1000-595-GN-WT	White on Green	25.40	–	7.62	1	Adhesive Stick-on Strips, Cut to Size
⊙	M4C-1000-595-CL-WT	White on Transparent	25.40	–	6.10	1	Adhesive Stick-on Strips, Cut to Size
▲	M4-17-595	Black on White	25.40	12.70	–	360	Adhesive Stick-on individual labels
▲	M4-49-595	Black on White	25.40	25.40	–	160	Adhesive Stick-on individual labels

Voice & datacom identification

Equipment, inside panel component, air conditioning & power gear labelling

Operational efficiency is also crucial in the datacenters' grey spaces in order to guarantee qualitative data availability and transfer. Clear identification may relieve the burden for data center maintenance or repair technicians in an effective way.

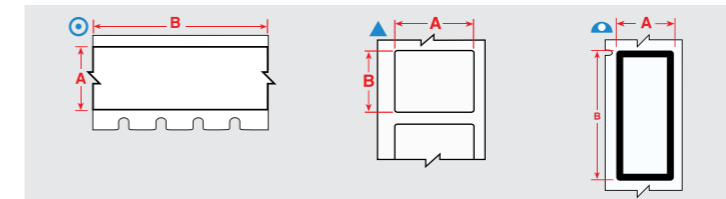

Diagram	Order Reference	Colour	Label Width A (mm)	Label Height B (mm)	Label Length B (m)	Labels per Roll	Additional Features
B-422: Polyester							
▲	M4-90-422	Black on White	19.05	38.10	–	180	Adhesive Stick-on individual labels
⊙	M4C-1000-422	Black on White	25.40	–	7.62	1	Adhesive Stick-on Strips: Outlet, Patch Panel, Cont. Tape, Cut to Size
▲	M4-49-422	Black on White	25.40	25.40	–	260	Adhesive Stick-on individual labels
B-423: Polyester							
⊙	M4C-1000-423	Black on White	25.40	–	7.62	1	Adhesive Stick-on Strips: Outlet, Patch Panel, Cont. Tape, Cut to Size
B-428: Metallised Polyester							
▲	M4-92-428-BB	Black on Light Grey	12.70	28.70	–	239	Rating & Nameplate labelling with a metal looking finish
▲	M4-47-428	Black on Light Grey	25.40	12.70	–	480	Rating & Nameplate labelling with a metal looking finish
▲	M4-60-428	Black on Light Grey	25.40	50.80	–	140	Rating & Nameplate labelling with a metal looking finish
B-430: Polyester							
⊙	M4C-1000-430	Black on Transparent	25.40	–	7.62	1	Adhesive Stick-on Strips: Outlet, Patch Panel, Cont. Tape, Cut to Size
B-595: Vinyl							
▲	M4-7-595	Black on White	12.70	12.70	–	280	Adhesive Stick-on individual labels
▲	M4-11-595	Black on White	19.05	12.70	–	360	Adhesive Stick-on individual labels
⊙	M4C-1000-595-YL-BK	Black on Yellow	25.40	–	7.62	1	Adhesive Stick-on Strips, Cut to Size
⊙	M4C-1000-595-OR-BK	Black on Orange	25.40	–	7.62	1	Adhesive Stick-on Strips, Cut to Size
⊙	M4C-1000-595-BL-WT	White on Blue	25.40	–	7.62	1	Adhesive Stick-on Strips, Cut to Size
⊙	M4C-1000-595-RD-WT	White on Red	25.40	–	7.62	1	Adhesive Stick-on Strips, Cut to Size
⊙	M4C-1000-595-CL-BK	Black on Transparent	25.40	–	6.10	1	Adhesive Stick-on Strips, Cut to Size
⊙	M4C-1000-595-GN-WT	White on Green	25.40	–	7.62	1	Adhesive Stick-on Strips, Cut to Size
⊙	M4C-1000-595-CL-WT	White on Transparent	25.40	–	6.10	1	Adhesive Stick-on Strips, Cut to Size
▲	M4-17-595	Black on White	25.40	12.70	–	360	Adhesive Stick-on individual labels
▲	M4-49-595	Black on White	25.40	25.40	–	160	Adhesive Stick-on individual labels

Outdoor towers, roadside cabinets and underground chambers labels

Improve visibility in low-light and inclement weather conditions with this reflective material.

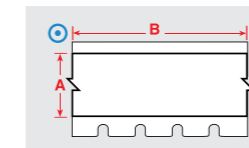
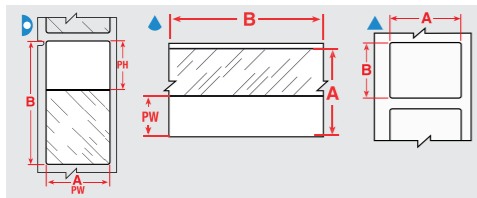

Diagram	Order Reference	Colour	Label Width A (mm)	Label Length B (m)
B-584: Reflective Tape				
⊙	M4C-500-584	Black on White	12.70	6.10
⊙	M4C-500-584-YL	Black on Yellow	12.70	6.10
⊙	M4C-750-584	Black on White	19.05	6.10
⊙	M4C-750-584-YL	Black on Yellow	19.05	6.10



Voice & datacom identification

Enjoy a more premium labelling experience with optimised Brady Authentic materials



Self-laminating wire & cable markers

Self-laminating markers feature a printable zone in white or yellow and a transparent, non printable area that wraps around wires and cables and serves as an overlamine to the printed text.

- Designed to adhere to highly curved surfaces, wires and cables
- Superior resistance to abrasion, handling, solvents, water, oil, dirt and more

Diagram	Order Reference	Colour	Label Width A (mm)	Label Height B (mm)	Label Length B (m)	Printable Area Width PW (mm)	Printable Area Height PH (mm)	Labels per Roll	Wire Diameter Range (mm)	For Data Cables Sized to Fit
B-427: Self-laminating Vinyl										
▲	M4-135-427-AW*	Black on White	6.35	27.94	-	6.35	27.94	240	4.00 - 8.00	CAT 5, CAT 6
▶	M4-11-427	Black on White, Transparent	12.70	19.05	-	12.70	9.53	360	2.00 - 3.00	4 Pair UTP Copper, CAT 6
▶	M4-47-427	Black on White, Transparent	12.70	25.40	-	12.70	9.53	360	2.70 - 5.10	2 Pair Fibre/Coaxial, Single/Multi mode fibre cables
▶	M4-102-427	Black on White, Transparent	12.70	31.75	-	12.70	9.53	200	3.40 - 7.10	CAT 5, CAT 6
▶	M4-89-427	Black on White, Transparent	12.70	38.10	-	12.70	12.70	180	4.00 - 8.10	CAT 5, CAT 6
▶	M4-48-427	Black on White, Transparent	19.05	25.40	-	19.05	9.53	200	2.00 - 3.00	CAT 5, CAT 6
▶	M4-90-427	Black on White, Transparent	19.05	38.10	-	19.05	12.70	180	4.00 - 8.10	CAT 5, CAT 6
▲	M4C-750-427	Black on White, Transparent	19.05	-	7.62 m	9.53	-	1	2.00 - 3.00	CAT 5, CAT 6
▶	M4-136-427	Black on White, Transparent	25.40	19.05	-	25.40	9.53	340	2.00 - 3.00	CAT 6, 4 Pair UTP Copper
▶	M4-49-427	Black on White, Transparent	25.40	25.40	-	25.40	9.53	260	2.70 - 5.10	2 Pair Fibre/Coaxial, Single/Multi mode fibre cables
▶	M4-143-427	Black on White, Transparent	25.40	31.75	-	25.40	12.70	200	3.40 - 6.10	CAT 5, CAT 6
▶	M4-91-427	Black on White, Transparent	25.40	38.10	-	25.40	12.70	180	4.00 - 8.10	CAT 5, CAT 6
▶	M4-91-427-YL	Black on Yellow, Transparent	25.40	38.10	-	25.40	12.70	180	4.00 - 8.10	CAT 5, CAT 6
▶	M4-51-427	Black on White, Transparent	25.40	63.50	-	25.40	19.05	110	6.70 - 14.20	25 Pair Copper, 4-12 pair Fibre, Coaxial
▶	M4-51-427-YL	Black on Yellow, Transparent	25.40	63.50	-	25.40	19.05	110	6.70 - 14.20	25 Pair Copper, 4-12 pair Fibre, Coaxial
▶	M4-53-427	Black on White, Transparent	25.40	101.60	-	25.40	25.40	70	10.80 - 24.30	24 Pair Fibre, Backbone, CAT 7
▶	M4-53-427-YL	Black on Yellow, Transparent	25.40	101.60	-	25.40	25.40	70	10.80 - 24.30	24 Pair Fibre, Backbone, CAT 7

*Order references ending with "AW" indicate all white labels with no clear area.

Voice & datacom identification

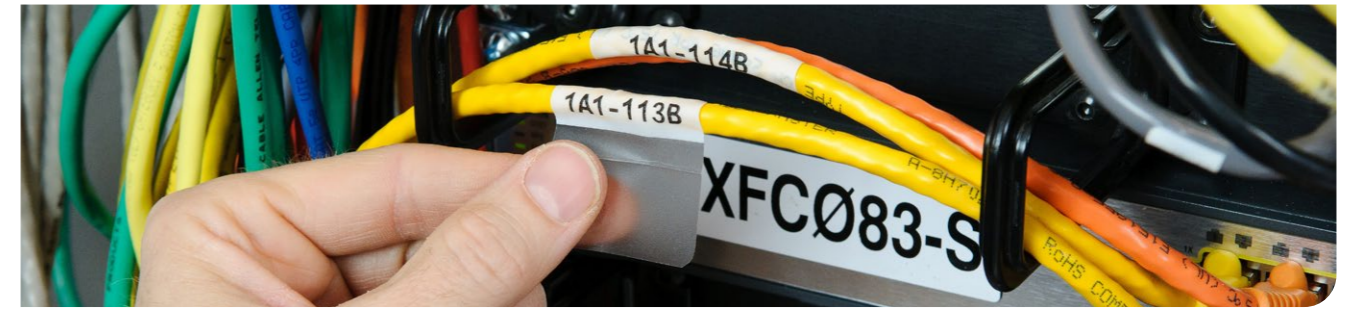

High adhesion self-laminating wire & cable markers

B-417 high-adhesion self-laminating vinyl wraps are for tough conditions, including high-humidity environments, small diameter wires and newer wire jacketing materials. Features a white printable area and a clear overlaminating area that protects the print.

- Dependable, long-term adhesion to small diameter wires
- Strong adhesion to a variety of wire jacketing materials, including Teflon™, silicone, braided and traditional PVC

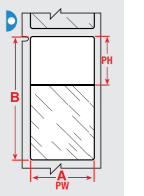

Diagram	Order Reference	Colour	Label Width A (mm)	Label Height B (mm)	Printable Area Width PW (mm)	Printable Area Height PH (mm)	Labels per Roll	Wire Diameter Range (mm)
B-417: Self-laminating Vinyl								
▶	M4-11-417	Black on White, Transparent	12.70	19.05	12.70	9.53	360	2.00 - 3.00
▶	M4-48-417	Black on White, Transparent	19.05	25.40	19.05	9.53	200	2.00 - 3.00
▶	M4-136-417	Black on White, Transparent	25.40	19.05	25.40	9.53	340	2.00 - 3.00
▶	M4-49-417	Black on White, Transparent	25.40	25.40	25.40	9.53	260	2.70 - 5.11
▶	M4-143-417	Black on White, Transparent	25.40	31.75	25.40	12.70	200	3.40 - 6.10
▶	M4-91-417	Black on White, Transparent	25.40	38.10	25.40	12.70	180	4.00 - 8.10
▶	M4-51-417	Black on White, Transparent	25.40	63.50	25.40	19.05	110	6.70 - 14.20
▶	M5-116-417	Black on White, Transparent	38.10	63.50	38.10	19.05	80	6.70 - 14.20



Rotating self-laminating wire & cable markers

The B-427 self-laminating Rotating Label can be rotated around a cable thanks to a non-adhesive printable zone and a translucent, self-adhesive laminate that is wrapped around a cable.

- Faster cable identification thanks to a label that can be rotated around a cable to make its print visible from any angle
- Industrial grade label that stays attached and remains legible on cables and components
- Spins freely around your Cat 5 and fiber optic cables, no adhesive residue or label parts to cling to your wires

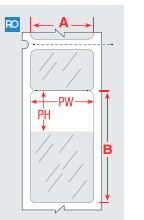

Diagram	Order Reference	Colour	Label Width A (mm)	Label Height B (mm)	Printable Area Width PW (mm)	Printable Area Height PH (mm)	Labels per Roll	Wire Diameter Range (mm)
B-427: Self-laminating Vinyl								
▶	M4-206-RO-427	Black on White, Transparent	12.70	44.45	12.70	17.78	110	2.70 - 5.13
▶	M4-207-RO-427	Black on White, Transparent	12.70	69.85	12.70	27.94	70	4.00 - 8.07
▶	M4-211-RO-427	Black on White, Transparent	25.40	30.48	25.40	12.70	150	2.00 - 3.65
▶	M4-203-RO-427	Black on White, Transparent	25.40	44.45	25.40	17.78	110	2.70 - 5.13
▶	M4-209-RO-427	Black on White, Transparent	25.40	69.85	25.40	27.94	70	4.00 - 8.07



Voice & datacom identification



Cable flags

The flag wizard allows to create a flag label that perfectly wraps around a wire or cable, with the ends joined together to form a flag.

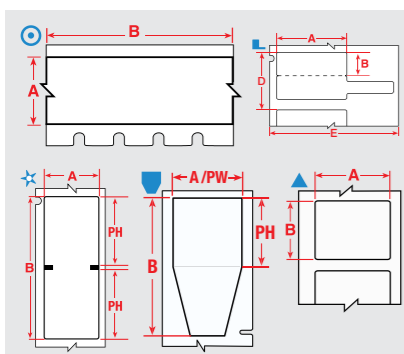
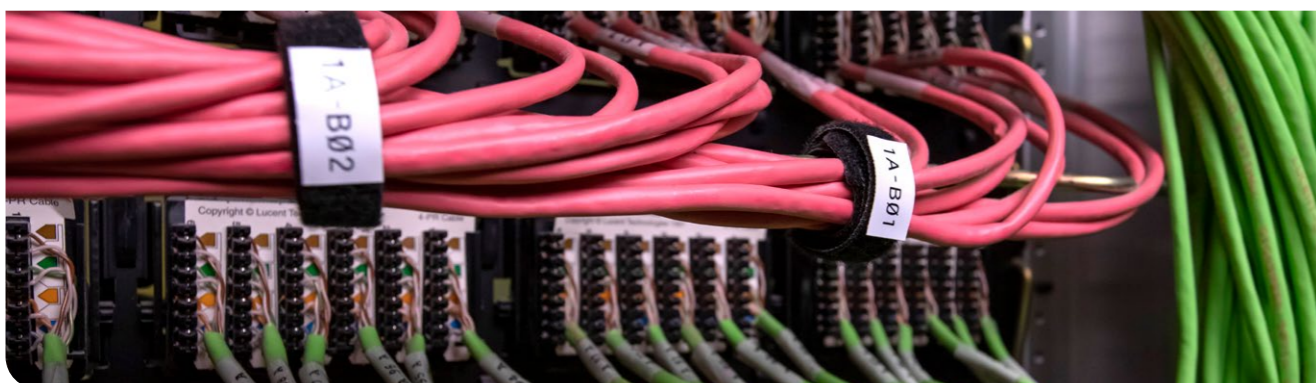

Diagram	Order Reference	Colour	Label Width A (mm)	Label Height B (mm)	Printable Area Height PH (mm)	Labels per Roll
B-425A: Polypropylene						
	M4-1-425-FP	Black on White	20.02	29.97	-	120
B-483A: Polyester						
	M4-61-483	Black on White	12.70	50.80	-	80
	M4-60-483	Black on White	25.40	50.80	-	140
	M4-47-483	Black on White	25.40	12.70	-	480
	M4-214-483	Black on White	25.40	50.80	25.40	140
B-499: Nylon Cloth						
	M4C-375-499	Black on White	9.53	-	-	1
	M4C-500-499	Black on White	12.70	-	-	1
	M4C-750-499	Black on White	19.05	-	-	1
	M4-141-499	Black on White	25.40	57.15	-	90



BradyGrip™ print-on hook material

BradyGrip™ Print-on Hook Material is a one-of-a-kind solution that allows identification to be easily printed and placed on bundles. A grippy backing makes it easy to reposition or remove, so no need for costly rework. Just print on and place - it's that simple.

- Maximises your uptime with faster, printable ID for cable bundles.
- Apply, reposition and remove with exclusive, print-and-place material.
- Offers a non-damaging alternative to nylon cable ties.
- Customise labels to fit big or small jobs by printing on different-width material.
- VELCRO® Brand ONE-WRAP® product not included with purchase.

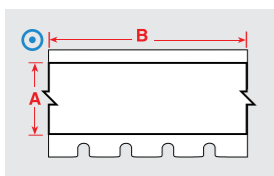

Diagram	Order Reference	Colour	Label Width A (mm)	Label Length B (m)	Recommended Velcro® One-Wrap® size range to use with BradyGrip™ (mm)
B-414: Polyester					
	M4C-250-414	Black on White	6.35	3.66	10 - 13
	M4C-500-414	Black on White	12.70	3.66	13 - 16
	M4C-750-414	Black on White	19.05	3.66	20 - 50



Electrical identification



PermaSleeve PS wire marking sleeves

Permanently mark wires with the durable PermaSleeve PS heat-shrink polyolefin sleeve label material, designed specifically for rigorous cable and wire marking applications.

- **Durable:** Self-extinguishing and resistant to extreme temperatures, UV light, chemicals, fuel and oil.
- **Efficient:** Fast shrinking with 3:1 shrink ratio; permanently adheres to wires quickly with a heat gun.
- **Certified:** UL Recognised to UL 224, RoHS Compliant to 2011/65/EU (Pass 2015/863), SAE AS23053/5 (Class 1), SAE AS-81531, MIL-STD-202.

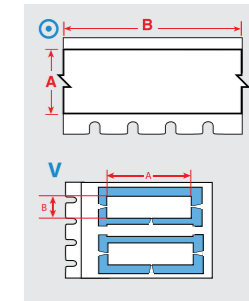

Diagram	Order Reference	Colour	Sleeve Width A (mm)	Sleeve Height B (mm)	Sleeve Length B (m)	Wire Diameter Range (mm)	Sleeves per Roll
B-342: Heat-shrink Polyolefin							
	M4-125-075-342	Black on White	19.05	5.97	-	1.17 - 2.79	80
	M4-187-075-342	Black on White	19.05	8.51	-	1.57 - 3.81	80
	M4-250-075-342	Black on White	19.05	11.15	-	2.39 - 5.46	80
	M4-375-075-342	Black on White	19.05	16.38	-	3.18 - 8.13	80
	M4C-125-342	Black on White	-	5.97	2.13	1.17 - 2.79	1
	M4C-125-342-YL	Black on Yellow	-	5.97	2.13	1.17 - 2.79	1
	M4C-187-342	Black on White	-	8.51	2.13	1.57 - 3.81	1
	M4C-187-342-YL	Black on Yellow	-	8.51	2.13	1.57 - 3.81	1
	M4C-250-342	Black on White	-	11.15	2.13	2.39 - 5.46	1
	M4C-250-342-YL	Black on Yellow	-	11.15	2.13	2.39 - 5.46	1
	M4C-375-342	Black on White	-	16.38	2.13	3.18 - 8.13	1



PermaSleeve Low Smoke Zero Halogen wire marking sleeves

Permanently mark wires and cables with the low-smoke, halogen-free B-7641 polyolefin label material, designed for mass-transit and marine applications where flame-retardant, low-smoke wire marking materials are required.

- **Durable:** Flame-retardant and resistant to temperatures from -30°C to 105°C.
- **Efficient:** Fast shrinking with a 2:1 shrink ratio; permanently adheres to wires quickly with a heat gun.
- **Certified:** RoHS compliant to 2011/65/EU (Pass 2015/863).

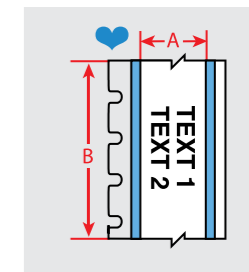

Diagram	Order Reference	Colour	Sleeve Height B (mm)	Sleeve Length B (m)	Wire Diameter Range (mm)	Sleeves per Roll
B-7641: Heat-shrink Polyolefin						
	M4C-125-7641	Black on White	5.97	1.68	1.57 - 2.79	1
	M4C-125-7641-YL	Black on Yellow	5.97	1.68	1.57 - 2.79	1
	M4C-187-7641	Black on White	8.51	1.68	2.39 - 3.81	1
	M4C-187-7641-YL	Black on Yellow	8.51	1.68	2.39 - 3.81	1
	M4C-250-7641	Black on White	11.15	1.68	3.18 - 5.46	1
	M4C-250-7641-YL	Black on Yellow	11.15	1.68	3.18 - 5.46	1
	M4C-375-7641	Black on White	16.38	1.68	4.78 - 8.13	1
	M4C-375-7641-YL	Black on Yellow	16.38	1.68	4.78 - 8.13	1

Electrical identification



Self-laminating wire & cable markers

Self-laminating markers feature a printable zone in white or yellow and a transparent, non printable area that wraps around wires and cables and serves as an overlaminating to the printed text.

- Designed to adhere to highly curved surfaces, wires and cables
- Superior resistance to abrasion, handling, solvents, water, oil, dirt and more

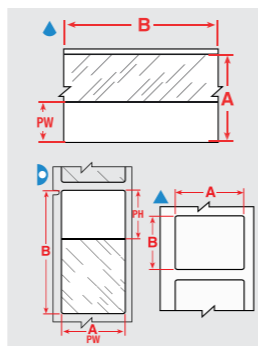

Diagram	Order Reference	Colour	Label Width A (mm)	Label Height B (mm)	Label Length B (m)	Printable Area Width PW (mm)	Printable Area Height PH (mm)	Wire Diameter Range (mm)	Labels per Roll
B-427: Self-laminating Vinyl									
▲	M4-135-427-AW*	Black on White	6.35	27.94	–	6.35	27.94	4.00 - 8.00	240
▶	M4-11-427	Black on White, Transparent	12.70	19.05	–	12.70	9.53	2.00 - 3.00	360
▶	M4-47-427	Black on White, Transparent	12.70	25.40	–	12.70	9.53	2.70 - 5.10	360
▶	M4-102-427	Black on White, Transparent	12.70	31.75	–	12.70	9.53	3.40 - 7.10	200
▶	M4-89-427	Black on White, Transparent	12.70	38.10	–	12.70	12.70	4.00 - 8.10	180
▶	M4-48-427	Black on White, Transparent	19.05	25.40	–	19.05	9.53	2.00 - 3.00	200
▶	M4-90-427	Black on White, Transparent	19.05	38.10	–	19.05	12.70	4.00 - 8.10	180
▲	M4C-750-427	Black on White, Transparent	19.05	–	7.62 m	9.53	–	2.00 - 3.00	1
▶	M4-136-427	Black on White, Transparent	25.40	19.05	–	25.40	9.53	2.00 - 3.00	340
▶	M4-49-427	Black on White, Transparent	25.40	25.40	–	25.40	9.53	2.70 - 5.10	260
▶	M4-143-427	Black on White, Transparent	25.40	31.75	–	25.40	12.70	3.40 - 6.10	200
▶	M4-91-427	Black on White, Transparent	25.40	38.10	–	25.40	12.70	4.00 - 8.10	180
▶	M4-91-427-YL	Black on Yellow, Transparent	25.40	38.10	–	25.40	12.70	4.00 - 8.10	180
▶	M4-51-427	Black on White, Transparent	25.40	63.50	–	25.40	19.05	6.70 - 14.20	110
▶	M4-51-427-YL	Black on Yellow, Transparent	25.40	63.50	–	25.40	19.05	6.70 - 14.20	110
▶	M4-53-427	Black on White, Transparent	25.40	101.60	–	25.40	25.40	10.80 - 24.30	70
▶	M4-53-427-YL	Black on Yellow, Transparent	25.40	101.60	–	25.40	25.40	10.80 - 24.30	70

*Order references ending with "AW" indicate all white labels with no clear area.



High adhesion self-laminating wire & cable markers

B-417 high-adhesion self-laminating vinyl wraps are for tough conditions, including high-humidity environments, small diameter wires and newer wire jacketing materials. Features a white printable area and a clear overlaminating area that protects the print.

- Dependable, long-term adhesion to small diameter wires
- Strong adhesion to a variety of wire jacketing materials, including Teflon™, silicone, braided and traditional PVC

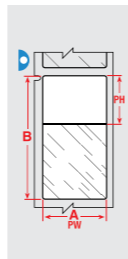

Diagram	Order Reference	Colour	Label Width A (mm)	Label Height B (mm)	Printable Area Width PW (mm)	Printable Area Height PH (mm)	Labels per Roll	Wire Diameter Range (mm)
B-417: Self-laminating Vinyl								
▶	M4-11-417	Black on White, Transparent	12.70	19.05	12.70	9.53	360	2.00 - 3.00
▶	M4-48-417	Black on White, Transparent	19.05	25.40	19.05	9.53	200	2.00 - 3.00
▶	M4-136-417	Black on White, Transparent	25.40	19.05	25.40	9.53	340	2.00 - 3.00
▶	M4-49-417	Black on White, Transparent	25.40	25.40	25.40	9.53	260	2.70 - 5.11
▶	M4-143-417	Black on White, Transparent	25.40	31.75	25.40	12.70	200	3.40 - 6.10
▶	M4-91-417	Black on White, Transparent	25.40	38.10	25.40	12.70	180	4.00 - 8.10
▶	M4-51-417	Black on White, Transparent	25.40	63.50	25.40	19.05	110	6.70 - 14.20
▶	M5-116-417	Black on White, Transparent	38.10	63.50	38.10	19.05	80	6.70 - 14.20

Electrical identification

Breaker box identification

Specially designed markers that offer a highly unique adhesive for excellent holding power to stick to all kinds of synthetic plastics or composite materials electrical panel covers can be made of. Specially designed narrow or medium-narrow width continuous tapes for easy mounting and alignment with the electrical circuit breakers.

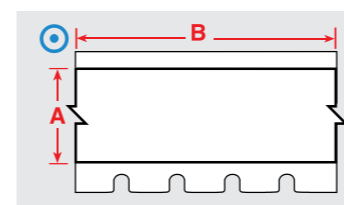

Diagram	Order Reference	Colour	Label Width A (mm)	Label Length B (m)	Labels per Roll
B-422: Polyester					
⊙	M4C-375-422	Black on White	9.53	7.62 m	1
⊙	M4C-475-422	Black on White	12.07	7.62 m	1
⊙	M4C-625-422	Black on White	15.88	7.62 m	1

Identification can also take place on the cover or lid with these bigger tapes:

Diagram	Order Reference	Colour	Label Width A (mm)	Label Length B (m)	Labels per Roll
B-422: Polyester					
⊙	M4C-500-422	Black on White	12.70	7.62 m	1
⊙	M4C-1000-422	Black on White	25.40	7.62 m	1
B-423: Polyester					
⊙	M4C-1000-423	Black on White	25.40	7.62 m	1
B-430: Polyester					
⊙	M4C-1000-430	Black on Transparent	25.40	7.62 m	1



Electrical identification



Rotating self-laminating wire & cable markers

The B-427 self-laminating Rotating Label can be rotated around a cable thanks to a non-adhesive printable zone and a translucent, self-adhesive laminate that is wrapped around a cable.

- Faster cable identification thanks to a label that can be rotated around a cable to make its print visible from any angle
- Industrial grade label that stays attached and remains legible on cables and components

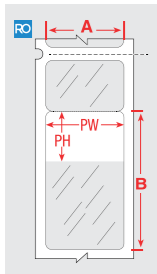
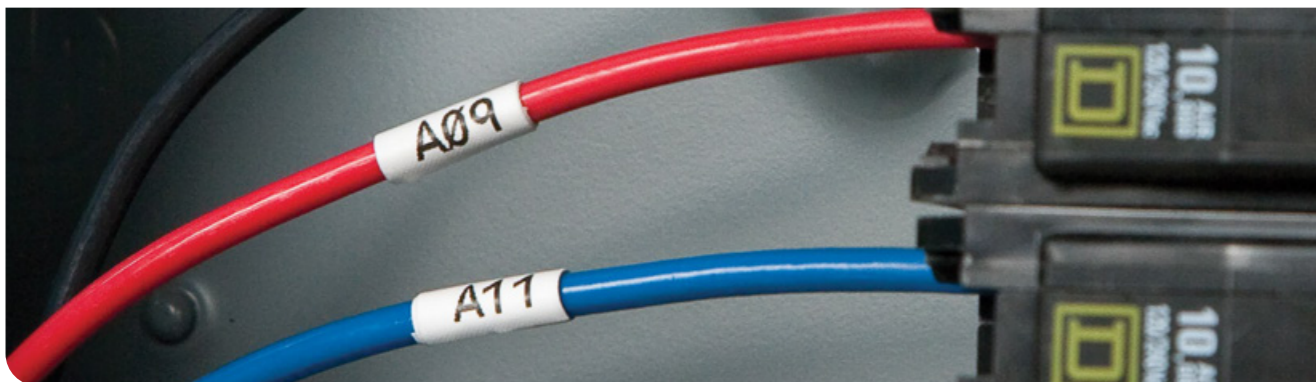

Diagram	Order Reference	Colour	Label Width A (mm)	Label Height B (mm)	Printable Area Width PW (mm)	Printable Area Height PH (mm)	Wire Diameter Range (mm)	Labels per Roll
B-427: Self-laminating Vinyl								
FO	M4-206-RO-427	Black on White, Transparent	12.70	44.45	12.70	17.78	2.70 - 5.13	110
FO	M4-207-RO-427	Black on White, Transparent	12.70	69.85	12.70	27.94	4.00 - 8.07	70
FO	M4-211-RO-427	Black on White, Transparent	25.40	30.48	25.40	12.70	2.00 - 3.65	150
FO	M4-203-RO-427	Black on White, Transparent	25.40	44.45	25.40	17.78	2.70 - 5.13	110
FO	M4-209-RO-427	Black on White, Transparent	25.40	69.85	25.40	27.94	4.00 - 8.07	70



Wrap around wire & cable markers

Durable vinyl cloth wrap around wire and cable markers made with an adhesive that allows the markers to be removed cleanly and re-applied if necessary.

- Highly unique adhesive and cloth construction
- Ideal choice for marking both ends of a wire that may need be cut shorter before final termination

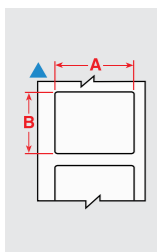

Diagram	Order Reference	Colour	Label Width A (mm)	Label Height B (mm)	Wire Diameter Range (mm)	Labels per Roll
B-498: Vinyl Cloth						
▲	M4-7-498	Black on White	12.70	12.70	4.00 - 8.10	240
▲	M4-11-498	Black on White	19.05	12.70	4.00 - 8.10	220
▲	M4-131-498	Black on White	25.40	12.70	4.00 - 8.10	180
▲	M4-91-498	Black on White	25.40	38.10	10.80 - 20.19	120
▲	M4-48-498	Black on White	25.40	19.05	6.70 - 14.20	180
▲	M4-49-498	Black on White	25.40	25.40	7.11 - 13.11	160

Electrical identification

Terminal block markers

Specially designed markers that offer a highly unique adhesive and vinyl cloth construction for excellent holding power, while still allowing for clean removal and application.

- Specially designed narrow-width continuous label for alignment on terminal blocks and patch panels
- Software can auto-serialise these labels to help save you time

Diagram	Order Reference	Colour	Label Width A (mm)	Label Length B (m)
B-498: Vinyl Cloth				
⊙	M4C-240-498	Black on White	6.10	4.88 m
⊙	M4C-318-498	Black on White	8.08	4.88 m
⊙	M4C-375-498	Black on White	9.53	6.10 m

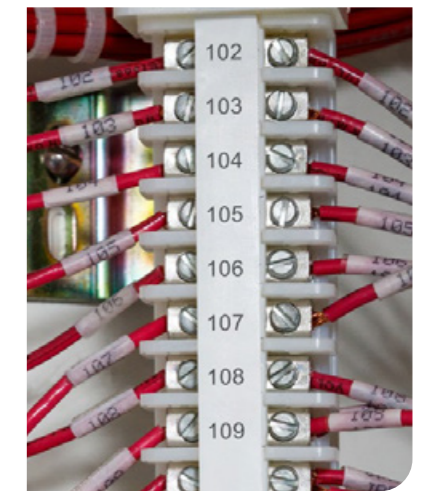
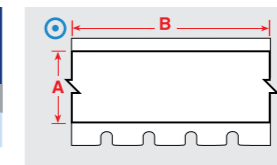

Control panel and electrical panel labels

Long-lasting, durable materials to quickly identify control and electrical panels.

Diagram	Order Reference	Colour	Label Width A (mm)	Label Height B (mm)	Label Length B (m)	Labels per Roll
B-422: Polyester						
⊙	M4C-625-422	Black on White	15.88	-	7.62 m	1
B-423: Polyester						
⊙	M4C-1000-423	Black on White	25.40	-	7.62 m	1
B-428: Metallised Polyester						
▲	M4-47-428	Black on Light Grey	25.40	12.70	-	480
▲	M4-60-428	Black on Light Grey	25.40	50.80	-	140
B-430: Polyester						
⊙	M4C-1000-430	Black on Transparent	25.40	-	7.62 m	1

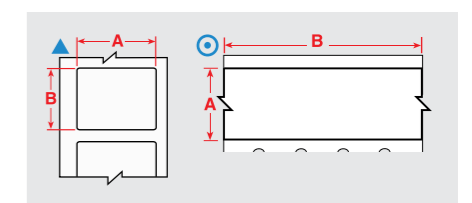

Magnet accessory available

The M410 Label Printer offers a heavy-duty magnet accessory that allows you to go hands free. Apply the magnet to the back of your printer and then simply place on a magnetic surface.

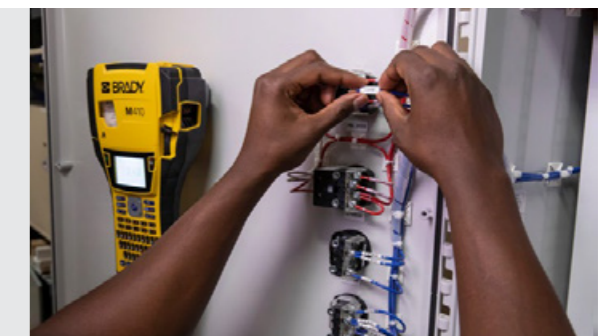



Electrical identification



Automation & electrical component markers

Various sizes, colours and label types for marking relays, solenoids, switches, drive motors, and other components.

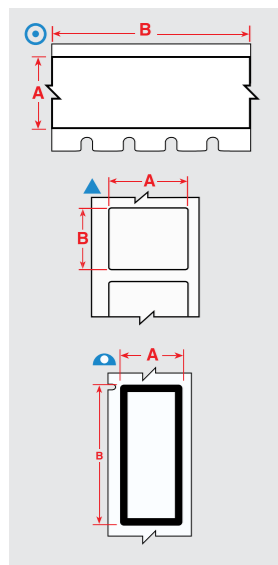

Diagram	Order Reference	Colour	Label Width A (mm)	Label Height B (mm)	Label Length B (m)	Labels per Roll
B-422: Polyester						
⊙	M4C-500-422	Black on White	12.70	–	7.62 m	1
▲	M4-7-422	Black on White	12.70	12.70	–	280
▲	M4-89-422	Black on White	12.70	38.10	–	180
▲	M4-90-422	Black on White	19.05	38.10	–	180
⊙	M4C-1000-422	Black on White	25.40	–	7.62 m	1
▲	M4-47-422	Black on White	25.40	12.70	–	480
▲	M4-49-422	Black on White	25.40	25.40	–	260
B-423: Polyester						
⊙	M4C-1000-423	Black on White	25.40	–	7.62 m	1
B-428: Metallised Polyester						
▲	M4-92-428-BB	Black on Light Grey	12.70	28.70	–	239
▲	M4-47-428	Black on Light Grey	25.40	12.70	–	480
▲	M4-60-428	Black on Light Grey	25.40	50.80	–	140
B-430: Polyester						
⊙	M4C-1000-430	Black on Transparent	25.40	–	7.62 m	1
B-483A: Polyester						
▲	M4-61-483	Black on White	12.70	50.80	–	80
▲	M4-60-483	Black on White	25.40	50.80	–	140
▲	M4-47-483	Black on White	25.40	12.70	–	480
B-499: Nylon Cloth						
⊙	M4C-375-499	Black on White	9.53	–	4.88 m	1
⊙	M4C-500-499	Black on White	12.70	–	4.88 m	1
⊙	M4C-750-499	Black on White	19.05	–	4.88 m	1
▲	M4-11-499	Black on White	19.05	12.70	–	220
▲	M4-130-499	Black on White	20.96	9.53	–	220
▲	M4-131-499	Black on White	25.40	12.70	–	180
▲	M4-128-499	Black on White	48.26	25.40	–	100
B-595: Vinyl						
⊙	M4C-500-595-OR-BK	Black on Orange	12.70	–	7.62 m	1
⊙	M4C-750-595-OR-BK	Black on Orange	19.05	–	7.62 m	1
⊙	M4C-1000-595-OR-BK	Black on Orange	25.40	–	7.62 m	1
▲	M4-7-595	Black on White	12.70	12.70	–	280
▲	M4-11-595	Black on White	19.05	12.70	–	360
▲	M4-17-595	Black on White	25.40	12.70	–	360
▲	M4-49-595	Black on White	25.40	25.40	–	160
⊙	M4C-500-595-YL-BK	Black on Yellow	12.70	–	7.62 m	1
⊙	M4C-750-595-YL-BK	Black on Yellow	19.05	–	7.62 m	1
⊙	M4C-1000-595-YL-BK	Black on Yellow	25.40	–	7.62 m	1

Facility & safety identification



Bin, storage, reflective and general industrial labels

Choose from several materials and types of labels that offer an aggressive adhesive for use in commercial and industrial applications. Bin, storage & industrial labels are ideal for commercial / industrial applications, while reflective can be used for low light or inclement weather conditions.

- Recommended for low surface energy and textured surfaces
- Reflective is ideal for outdoor utility poles and pedestals, equipment on site and rooftop equipment

Diagram	Order Reference	Colour	Label Width A (mm)	Label Height B (mm)	Label Length B (m)	Labels per Roll
B-403: Paper						
⊙	M4C-750-403	Black on White	19.05	–	7.62 m	1
B-422: Polyester						
⊙	M4C-375-422	Black on White	9.53	–	7.62 m	1
⊙	M4C-475-422	Black on White	12.07	–	7.62 m	1
▲	M4-7-422	Black on White	12.70	12.70	–	280
▲	M4-89-422	Black on White	12.70	38.10	–	180
⊙	M4C-500-422	Black on White	12.70	–	7.62 m	1
▲	M4-90-422	Black on White	19.05	38.10	–	180
▲	M4-47-422	Black on White	25.40	12.70	–	480
▲	M4-49-422	Black on White	25.40	25.40	–	260
⊙	M4C-1000-422	Black on White	25.40	–	7.62 m	1
B-423: Polyester						
⊙	M4C-1000-423	Black on White	25.40	–	7.62 m	1
B-430: Polyester						
⊙	M4C-1000-430	Black on Transparent	25.40	–	7.62 m	1
B-483A: Polyester						
▲	M4-61-483	Black on White	12.70	50.80	–	80
▲	M4-47-483	Black on White	25.40	12.70	–	480
▲	M4-60-483	Black on White	25.40	50.80	–	140
B-499: Nylon Cloth						
▲	M4-11-499	Black on White	19.05	12.70	–	220
▲	M4-22-499	Black on White	25.40	76.20	–	100
▲	M4-128-499	Black on White	48.26	25.40	–	100
B-584: Reflective Tape						
⊙	M4C-500-584	Black on White	12.70	–	6.10 m	1
⊙	M4C-500-584-YL	Black on Yellow	12.70	–	6.10 m	1
⊙	M4C-750-584	Black on White	19.05	–	6.10 m	1
⊙	M4C-750-584-YL	Black on Yellow	19.05	–	6.10 m	1
B-595: Vinyl						
⊙	M4C-500-595-RD-WT	White on Red	12.70	–	7.62 m	1
⊙	M4C-750-595-RD-WT	White on Red	19.05	–	7.62 m	1
▲	M4-22-595	Black on White	25.40	76.20	–	100
⊙	M4C-1000-595-RD-WT	White on Red	25.40	–	7.62 m	1

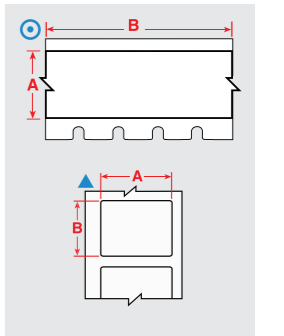

Facility & safety identification

Enjoy a more premium labelling experience with optimised Brady Authentic materials



Repositionable vinyl (B-581)

Best choice for indoor marking where frequent repositioning is required, such as shelves. Special adhesive allows easy removal of label to re-apply again and again.

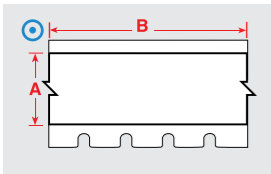

Diagram	Order Reference	Colour	Label Width A (mm)	Label Length B (m)	Labels per Roll
B-581: Vinyl					
	M4C-1000-581-WT	Black on White	25.40	7.62 m	1
	M5C-1500-581-WT	Black on White	38.10	7.62 m	1



Indoor/Outdoor Grade Facility & Safety Labels

Pliable vinyl that conforms well to smooth or rough surfaces such as pipes, walls, doors, panels, shelving, bins and equipment. Lasting up to 8-10* years outdoors, these labels offer excellent resistance to oils, detergents, dirt, grime and many solvents.

- Durable, low-shrink vinyl with our most aggressive adhesive
- Works for a variety of applications, including 5S labels, pipe markers, arc flash, chemical labels and more

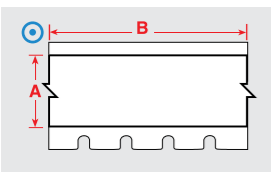

Diagram	Order Reference	Colour	Label Width A (mm)	Label Length B (m)	Labels per Roll
B-595: Vinyl					
	M4C-500-595-OR-BK	Black on Orange	12.70	7.62 m	1
	M4C-750-595-OR-BK	Black on Orange	19.05	7.62 m	1
	M4C-1000-595-OR-BK	Black on Orange	25.40	7.62 m	1
	M4C-500-595-CL-BK	Black on Transparent	12.70	6.10 m	1
	M4C-750-595-CL-BK	Black on Transparent	19.05	6.10 m	1

* Average expected outdoor life of product will depend on user definition of failure, climatic conditions, mounting techniques and material colour. The 8 to 10 year outdoor durability applies to the vinyl label stock only; ribbon durability will vary. A polyester overlamine is recommended for harsh environments - long term exposure to wind and rain.

Facility & safety identification

Indoor/Outdoor Grade Facility & Safety Labels (Continued)



Diagram	Order Reference	Colour	Label Width A (mm)	Label Length B (m)	Labels per Roll
B-595: Vinyl					
	M4C-1000-595-CL-BK	Black on Transparent	25.40	6.10 m	1
	M4C-500-595-WT-BK	Black on White	12.70	7.62 m	1
	M4C-750-595-WT-BK	Black on White	19.05	7.62 m	1
	M4C-1000-595-WT-BK	Black on White	25.40	7.62 m	1
	M4C-375-595-WT-BK	Black on White	9.53	7.62 m	1
	M4C-500-595-YL-BK	Black on Yellow	12.70	7.62 m	1
	M4C-750-595-YL-BK	Black on Yellow	19.05	7.62 m	1
	M4C-1000-595-YL-BK	Black on Yellow	25.40	7.62 m	1
	M4C-375-595-YL-BK	Black on Yellow	9.53	7.62 m	1
	M4C-500-595-WT-RD	Red on White	12.70	7.62 m	1
	M4C-750-595-WT-RD	Red on White	19.05	7.62 m	1
	M4C-1000-595-WT-RD	Red on White	25.40	7.62 m	1
	M4C-500-595-BK-WT	White on Black	12.70	7.62 m	1
	M4C-750-595-BK-WT	White on Black	19.05	7.62 m	1
	M4C-1000-595-BK-WT	White on Black	25.40	7.62 m	1
	M4C-500-595-BL-WT	White on Blue	12.70	7.62 m	1
	M4C-750-595-BL-WT	White on Blue	19.05	7.62 m	1
	M4C-1000-595-BL-WT	White on Blue	25.40	7.62 m	1
	M4C-500-595-GN-WT	White on Green	12.70	7.62 m	1
	M4C-750-595-GN-WT	White on Green	19.05	7.62 m	1
	M4C-1000-595-GN-WT	White on Green	25.40	7.62 m	1
	M4C-500-595-RD-WT	White on Red	12.70	7.62 m	1
	M4C-750-595-RD-WT	White on Red	19.05	7.62 m	1
	M4C-1000-595-RD-WT	White on Red	25.40	7.62 m	1
	M4C-375-595-RD-WT	White on Red	9.53	7.62 m	1
	M4C-500-595-CL-WT	White on Transparent	12.70	6.10 m	1
	M4C-750-595-CL-WT	White on Transparent	19.05	6.10 m	1
	M4C-1000-595-CL-WT	White on Transparent	25.40	6.10 m	1

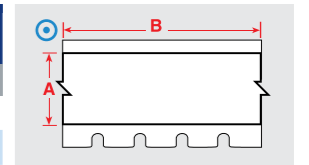

* Average expected outdoor life of product will depend on user definition of failure, climatic conditions, mounting techniques and material colour. The 8 to 10 year outdoor durability applies to the vinyl label stock only; ribbon durability will vary. A polyester overlamine is recommended for harsh environments - long term exposure to wind and rain.



Laboratory identification

Specimen tracking identification



Vial top labels

Save time by using the Vial and Vial top combination labels - print your information in one go.

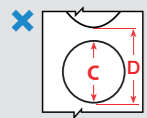

Diagram	Order Reference	Material	Special Properties	Diameter C (mm)	Labels per Roll
1.5 mL					
✘	M4-82-492	B-492	F H L	9.53	240
2.0 mL					
✘	M4-83-492	B-492	F H L	12.70	240

Specimen process marking



Centrifuge / microcentrifuge labels

Brady offers a wide range of Centrifuge, Eppendorf and PCR Labels. When applying a self-laminating label, we recommend you avoid touching the adhesive side of the label when wrapping it around a vial or tube, to ensure maximum adhesion.

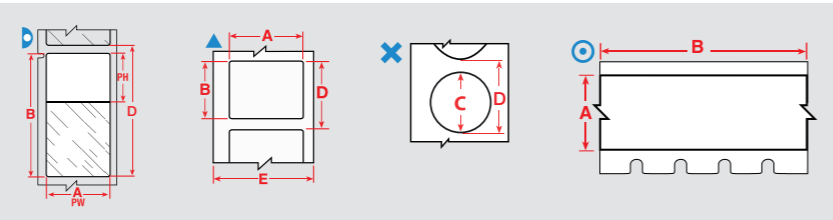

Diagram	Order Reference	Material	Special Properties	Label Width A (mm)	Label Height B (mm)	Label Length B (m)	Diameter C (mm)	Printable Area Width PW (mm)	Printable Area Height PH (mm)	Labels per Roll
0.5 mL										
⊙	M4C-500-461	B-461	F N A H S L	12.70	-	7.62	-	-	-	1
⊙	M4C-500-492	B-492	F N H L	12.70	-	7.62	-	-	-	1
▲	M4-130-492	B-492	F N H L	20.96	9.53	-	-	-	-	220
▲	M4-131-492	B-492	F N H L	25.40	12.70	-	-	-	-	180
▷	M4-124-461	B-461	F N A H S L	41.91	12.70	-	-	19.05	12.70	180
▷	M4-72-461	B-461	F N A H S L	44.45	12.70	-	-	19.05	12.70	180
▷	M4-74-461	B-461	F N A H S L	55.88	12.70	-	-	19.05	12.70	140
1.5 mL										
▷	M4-126-461	B-461	F N A H S L	45.72	15.24	-	-	25.40	15.24	180
▷	M4-86-461	B-461	F N A H S L	66.68	15.24	-	-	25.40	15.24	120
✘	M4-82-492	B-492	F H L	-	-	-	9.53	-	-	240
2.0 mL										
✘	M4-83-492	B-492	F H L	-	-	-	12.70	-	-	240
4.0 mL										
▲	M4-124-490	B-490	F N H L	12.70	41.91	-	-	-	-	180
8.0 mL										
▲	M4-126-490	B-490	F N H L	45.72	15.24	-	-	-	-	180

F Freezer environment **N** Liquid nitrogen environment **A** Autoclave environment **H** Hot water bath (100°C) **S** Self-laminating label **L** Low-profile label (extremely thin) **R** Removable



Laboratory identification

Specimen process marking

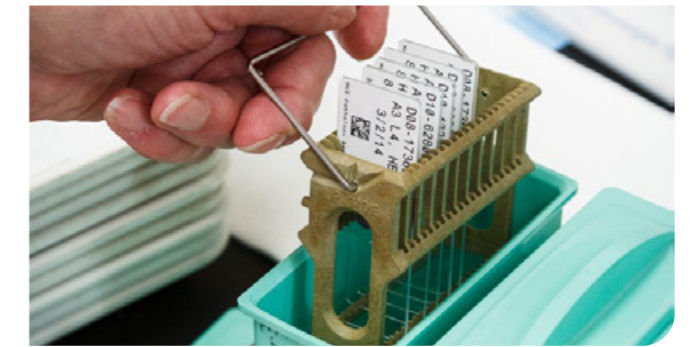

Slide labels

Brady offers labels specifically designed to identify slides and to resist exposure to harsh chemicals during the slide staining process. They perform well in the hematoxylin and eosin slide staining process and offer superior chemical resistance also useful in other laboratory contexts.

Diagram	Order Reference	Material	Special Properties	Label Width A (mm)	Label Height B (mm)	Labels per Roll
▲	M4-81-488	B-488	F A	48.26	6.35	160

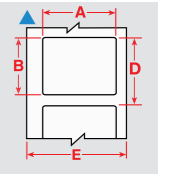

Specimen storage identification



Cryo tubes & vials

Brady offers a range of labels designed specifically to identify laboratory samples for cryo storage. These labels can be applied to room temperature or to already frozen samples, albeit with a small overlap. The label will remain legible and will stick to the sample container during processing, even when exposed to extreme heat or chemicals like DMSO, Xylene and Ethanol, ensuring secure sample identification in the most challenging laboratory conditions.

Diagram	Order Reference	Material	Special Properties	Label Width A (mm)	Label Height B (mm)	Label Length B (m)	Printable Area Width PW (mm)	Printable Area Height PH (mm)	Labels per Roll
0.5 mL									
⊙	M4C-375-461	B-461	F N A H S L	9.53	-	7.62	-	-	1
⊙	M4C-500-461	B-461	F N A H S L	12.70	-	7.62	-	-	1
▲	M4-130-492	B-492	F N H L	20.96	9.53	-	-	-	220
▲	M4-131-492	B-492	F N H L	25.40	12.70	-	-	-	180
▷	M4-72-461	B-461	F N A H S L	44.45	12.70	-	19.05	12.70	180
▷	M4-74-461	B-461	F N A H S L	55.88	12.70	-	19.05	12.70	140
1.5 mL									
▷	M4-126-461	B-461	F N A H S L	45.72	15.24	-	25.40	15.24	180
▷	M4-86-461	B-461	F N A H S L	66.68	15.24	-	25.40	15.24	120
2.0 mL									
⊙	M4C-1000-7425	B-7425	F N A H	25.40	-	7.62	-	-	1
8.0 mL									
▲	M4-126-490	B-490	F N H L	45.72	15.24	-	-	-	180

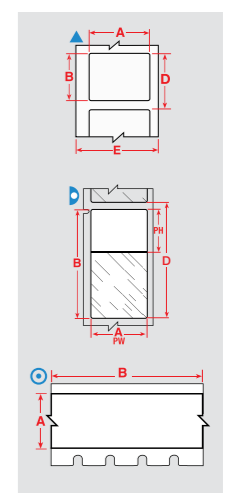

F Freezer environment **N** Liquid nitrogen environment **A** Autoclave environment **H** Hot water bath (100°C) **S** Self-laminating label **L** Low-profile label (extremely thin) **R** Removable



Laboratory identification

Specimen storage identification

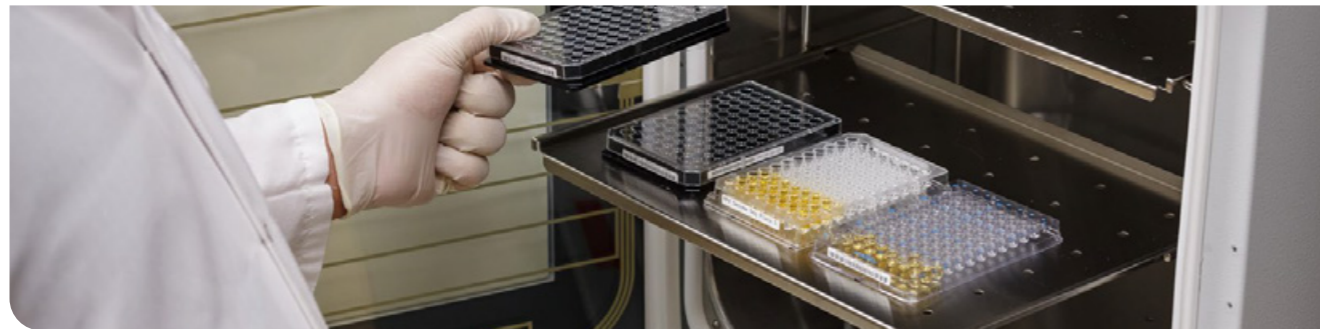

Well plate labels

When total tracking of all sample collections is required then Brady has a solution for Well plate identification. Our well plate labels guarantee crystal clear text and barcoding for most lab environments.

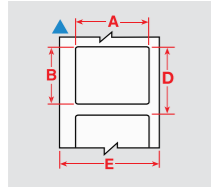

Diagram	Order Reference	Material	Special Properties	Label Width A (mm)	Label Height B (mm)	Labels per Roll
▲	M4-81-488	B-488	F A	48.26	6.35	160

Lean lab identification



Water dissolvable labels

B-403 water dissolvable paper label dissolves completely within 30 seconds exposure to warm water without damaging the surface or leaving sticky residue, making it ideal to label items that need new identification after every use.

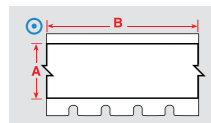

Diagram	Order Reference	Material	Special Properties	Label Width A (mm)	Label Length B (m)	Labels per Roll
⊙	M4C-750-403	B-403	R	19.05	7.62	1

F Freezer environment	N Liquid nitrogen environment	A Autoclave environment	H Hot water bath (100°C)	S Self-laminating label	L Low-profile label (extremely thin)	R Removable
------------------------------	--------------------------------------	--------------------------------	---------------------------------	--------------------------------	---	--------------------

M410 printer specifications

Specifications	
Print Technology	Thermal Transfer
Print Resolution (dpi)	300
Print Speed (mm/sec)	33
Colour Capability	Monocolour
Continuous vs Die-cut Labels	Continuous and Die-cut
Max. Label Width (mm)	25
Max. Print Length (mm)	990.60
Recommended Usage per Day	250
Connectivity Options	USB
Software Compatibility	Brady Workstation Windows based driver for 3rd party software use
Bar Code Type	Code 128 Code 39
Built-in Symbols	480
Physical Properties	
Width x Height x Depth (mm)	152.40 x 292.10 x 88.90
Weight (kg)	1.18
On Screen Indicators	Battery Life Ribbon and label part number recognition Supply Remaining
Cutter	Manual cut With label retention
Warranty	2 years
Drop Test	Resistant to 1.2 metre drops



Brady Workstation Basic Design includes fundamental apps and features to create labels.



M410 printer

Article No.	Description
177180	M410 Label Printer EU*
322719	M410 Label Printer UK*
322717	M410 Label Printer EU + Brady Workstation Suite**
322721	M410 Label Printer UK + Brady Workstation Suite**

*This M410 Printer ships in a cardboard box with a rechargeable NiMH Battery Pack, an AC Adapter, B-595 Vinyl label Cartridge, a Quick start Guide, a USB Cable, a Brady Workstation Basic Design Software Suite and a USB Flash Drive with Driver and User Manual.

**This M410 Printer ships in a cardboard box with a rechargeable NiMH Battery Pack, an AC Adapter, B-595 Vinyl label Cartridge, a Quick start Guide, a USB Cable, a licence for Brady Workstation Software suites and a USB Flash Drive with Driver and User Manual.

Accessories

Article No.	Description
176990	AC Adapter for M410, M510, M511, M610 and M611 Portable Printers
176995	Hard Case for M410 Portable Printer
176991	Magnet for M410 Portable Printer
150618	Protective softbag for portable printers
322804	Quick Charger EU for M410 Label Printer
322805	Quick Charger UK for M410 Label Printer
176993	Rechargeable Battery for M410, BMP41 and BMP61 Label Printers
176992	Utility Hook for M410 Printer

M410 printer kits

Article No.	Description
177184	M410 Portable Label Printer Kit EU*
322720	M410 Portable Label Printer Kit UK*
322718	M410 Portable Label Printer Kit EU + Brady Workstation Suite**
322722	M410 Portable Label Printer Kit UK + Brady Workstation Suite**

*This M410 Printer ships in a hardcase with a rechargeable NiMH Battery Pack, an AC Adapter, B-595 Vinyl label Cartridge, a Magnet, a Utility Hook, a Quick start Guide, a USB Cable, a Brady Workstation Basic Design Software Suite and a USB Flash Drive with Driver and User Manual.

**This M410 Printer ships in a hardcase with a rechargeable NiMH Battery Pack, an AC Adapter, B-595 Vinyl label Cartridge, a Magnet, a Utility Hook, a Quick start Guide, a USB Cable, a licence for Brady Workstation Software suites and a USB Flash Drive with Driver and User Manual.



Brady Workstation Advanced Suite: Product & Wire Identification, Safety & Facility Identification, or Lab Identification, enabling easy creation of a wide range of labels and signs.



Belgium & Luxembourg
+32 (0) 52 45 78 11
benelux@bradycorp.com

Czech Republic
+420 776 302 229
czechrepublic@bradycorp.com

Denmark
+45 66 14 44 00
denmark@bradycorp.com

France
+33 (0) 3 20 76 94 48
france@bradycorp.com

Germany, Austria & Switzerland
+49 (0) 6103 7598 660
germany@bradycorp.com

Hungary
+36 23 500 275
hungary@bradycorp.com

Italy
+39 02 26 00 00 22
italy@bradycorp.com

Netherlands
+31 (0)70 323 62 98
benelux@bradycorp.com

Norway
+47 70 13 40 00
norway@bradycorp.com

Poland
+48 22 104 6262
poland@bradycorp.com

Qatar, Saudi Arabia & UAE
+971 4881 2524
me@bradycorp.com

Slovakia
+421 902 939 406
slovakia@bradycorp.com

South Africa
+27 11 704 3295
africa@bradycorp.com

Spain & Portugal
+34 900 902 993
spain@bradycorp.com
portugal@bradycorp.com

**Sweden, Finland, Estonia, Latvia,
Lithuania**
+46 (0) 8 590 057 30
sweden@bradycorp.com

Turkey
Istanbul
+90 212 264 02 20
turkey@bradycorp.com

UK & Ireland
+44 (0) 1295 228 288
uk@bradycorp.com

Our mission is to identify and protect people,
products and premises



To help minimise our impact on the environment,
Brady limits its number of reprints.

Updated versions are always available for
download on www.bradyeurope.com.



Search for: EUR-M-445-EN



Y6156499

Your distributor