

Metallic systems

Flexible and bendable metal conduits	34
Glass fiber braided	50
PVC conduit	51
Connectors	55
Metal rigid conduits	74
Quick coupling fittings	77
Fastening elements	87
Glands	90
Boxes	104
Accessories	121
Conduit bending	134

Features of DKC Cosmec metallic systems



Range

A wide dimensional range of rigid and flexible conduits manufactured of galvanised steel or stainless steel and various types of coating complete with accessories allow creating protective systems of whatever complexity.

These solutions can satisfy all types of requirements and site conditions, such as operating temperature, chemical resistance, mechanical resistance and protection against water and dust.

Our systems of conduits and accessories full manufactured of AISI 316 are one-of-a-kind as regards to the finishing quality and wide range and are particularly suitable for food, chemical and naval applications.

Ease of installation

- The patented quick connection and release fittings guarantee an easy and quick installation thanks to the connections with steel ball locks. The protection degree against dust and humidity is up to IP66/IP67 with no additional accessories.
- A minor number of accessories is required thanks to solutions that integrate several functions in a single connector, such as direct rigid-to-flexible-conduit connectors, connectors with inbuilt gable gland and numerous types of threads available on stock.
- Junction boxes with perforated insulation do not require cables cutting.
- Polyurethane foam seals are pre-installed to the covers of boxes.
- Patented Spedyfix collars do not require screws and allow conduit fixing with no tools.

Reliability

- The conduits and connectors are subject to regular internal inspections and periodic audits by international certification bodies.
- The conduits are burr and roughness free in order to avoid cables damaging as well as injuries to the operator's hands.
- Metallic and plastic materials are of premium quality and provided with test certificates always requested to the suppliers.
- Stainless steel AISI 316 version guarantees a high corrosion resistance for applications in food and chemical sectors as well as in harsh environments.
- Aluminium junction boxes are pickled and painted in an oven with epoxy powders in order to provide a good corrosion resistance.
- Double-lock connectors for braided conduits provide excellent technical solutions.
- Metallic flexible and bendable conduits are available in 3 different types of form of section in order to better satisfy the exigencies of flexibility and mechanical features.

Ease of project development

- The complete system of rigid and flexible conduits, boxes, connectors and accessories allows to define a solution for whatever project.
- 2D and 3D models library is available.
- The range of conduits of galvanised steel and stainless steel with various types of polymeric coatings allows choosing an optimal version based on the operating conditions

CAD SERVICE

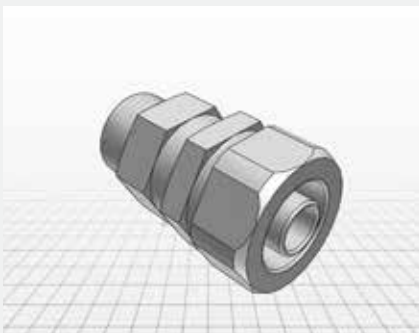

The CAD service of DKC COSMEC provides easy access to download CAD models to insert directly in the projects of installation. The models are available in 2D and 3D using the library of CAD CADENAS components, based on partcommunity technology. The download is free after registration at portal. Access to libraries through the site www.dkceurope.eu.

Field of application

DKC Cosmec metal conduits are designed to guarantee a protection for cables in industrial plants, building sector, highways and railways. For the purposes of safety these solutions are not hazardous as regards to fire, do not represent a flame propagation path and do not emit toxic gases or smokes.

A high protection degree against water and dust, a good resistance to mechanical impact and traction, to UV rays, to damaging effects of oils and solvents, good electromagnetic screening properties are only a few of the advantages of DKC Cosmec rigid and flexible metallic systems.



Manufacturing plants

Cable protection at factories, workshops and manufacturing plants against damages and aggressive environments



Fire hazardous areas

Cable protection in fire hazardous premises



Areas subject to presence of rodents

Cable protection at mills, animal feed plants, paper stocks, archives, woodworking plants, purification plants



Transport infrastructures

Cable protection at railways, highways, bridges, stations and tunnels



Crowded places

Cable protection at schools, hospitals, trade malls, stadiums, airports



Industrial plants

Cable protection in manufacturing lines and process plants



Areas subject to acts of vandalism

Cable protection at multi-level car parks, discotheques



Energy production plants











Cable protection at electrical power stations and hydroelectric stations



Food industry

Stainless steel cable protection systems

Metallic conduits

FLEXIBLE AND BENDABLE METALLIC CONDUITS		NECESSARY ACCESSORIES	OPTIONAL ACCESSORIES				
	667M	66BOTT		6014 (IP40)	6014-G (IP40)		6014-P (IP66/68)
	6070			6014 (IP66/67)	6014-G (IP66/67)	6014XX (IP66/67)	6014-P (IP66/68)
	607E			6014 (IP66/67)	6014-G (IP66/67)	6014XX (IP66/67)	6014-P (IP66/68)
	607ETX			6014 (IP66/67)	6014-G (IP66/67)		6014-P (IP66/68)
	6071		66BTP (IP66/IP67)	6014 (IP44)	6014-G (IP44)	6014XX (IP44)	6014-P (IP66/68)
	6071T		66BTP (IP66/IP67)	6014 (IP44)	6014-G (IP44)		6014-P (IP66/68)
	6071E		66BTP (IP66/IP67)	6014 (IP44)	6014-G (IP44)	6014XX (IP44)	6014-P (IP66/68)
	6071ETX		66BTP (IP66/IP67)	6014 (IP44)	6014-G (IP44)	6014XX (IP44)	6014-P (IP66/68)
	6071ET		66BTP (IP66/IP67)	6014 (IP44)	6014-G (IP44)		6014-P (IP66/68)
	607T	66BOTT		6014 (IP40)	6014-G (IP40)		6014-P (IP66/68)
	667DM	66BOTT		6014 (IP40)	6014-G (IP40)		6014-P (IP66/68)
	667DXM	66BOTT		6014 (IP40)	6014-G (IP40)	6014XX (IP40)	6014-P (IP66/68)
	607D			6014 (IP66/67)	6014-G (IP66/67)	6014XX (IP66/67)	6014-P (IP66/68)
	607PU			6014 (IP66/67)	6014-G (IP66/67)	6014XX (IP66/67)	6014-P (IP66/68)
	607DBT			6014 (IP66/67)	6014-G (IP66/67)	6014XX (IP66/67)	6014-P (IP66/68)
	667DXFTX	66BOTT		6014 (IP40)	6014-G (IP40)	6014XX (IP40)	6014-P (IP66/68)
	607X	6060X		6014 (IP66/67)	6014-G (IP66/67)	6014XX (IP66/67)	6014-P (IP66/68)
	607XX	6060X		6014 (IP66/67)	6014-G (IP66/67)	6014XX (IP66/67)	6014-P (IP66/68)

6015 (IP40)	6115 (IP40)	6024 (IP40)	6025 (IP40)	6117 (IP40)				
6015 (IP66/67)	6115 (IP66/67)	6024 (IP66/67)	6025 (IP66/67)	6117 (IP66/67)	6117XX (IP66/67)			
6015 (IP66/67)	6115 (IP66/67)	6024 (IP66/67)	6025 (IP66/67)	6117 (IP66/67)	6117XX (IP66/67)			
6015 (IP66/67)	6115 (IP66/67)	6024 (IP66/67)	6025 (IP66/67)	6117 (IP66/67)		T06014 (IP66/67)	T06014-G (IP66/67)	T06117 (IP66/67)
6015 (IP44)	6115 (IP44)	6024 (IP44)	6025 (IP44)	6117 (IP44)	6117XX (IP44)			
6015 (IP44)	6115 (IP44)	6024 (IP44)	6025 (IP44)	6117 (IP44)		T06014 (IP66/67)	T06014-G (IP66/67)	T06117 (IP66/67)
6015 (IP44)	6115 (IP44)	6024 (IP44)	6025 (IP44)	6117 (IP44)	6117XX (IP44)			
6015 (IP44)	6115 (IP44)	6024 (IP44)	6025 (IP44)	6117 (IP44)	6117XX (IP44)	T16014 (IP66/67)	T16014-G (IP66/67)	T16117 (IP66/67)
6015 (IP44)	6115 (IP44)	6024 (IP44)	6025 (IP44)	6117 (IP44)		T16014 (IP66/67)	T16014-G (IP66/67)	T16117 (IP66/67)
6015 (IP40)	6115 (IP40)	6024 (IP40)	6025 (IP40)	6117 (IP40)		TN6014 (IP40)	TN6014-G (IP40)	TN6117 (IP40)
6015 (IP40)	6115 (IP40)	6024 (IP40)	6025 (IP40)	6117 (IP40)				
6015 (IP40)	6115 (IP40)	6024 (IP40)	6025 (IP40)	6117 (IP40)	6117XX (IP40)			
6015 (IP66/67)	6115 (IP66/67)	6024 (IP66/67)	6025 (IP66/67)	6117 (IP66/67)	6117XX (IP66/67)			
6015 (IP66/67)	6115 (IP66/67)	6024 (IP66/67)	6025 (IP66/67)	6117 (IP66/67)	6117XX (IP66/67)			
6015 (IP66/67)	6115 (IP66/67)	6024 (IP66/67)	6025 (IP66/67)	6117 (IP66/67)	6117XX (IP66/67)			
6015 (IP40)	6115 (IP40)	6024 (IP40)	6025 (IP40)	6117 (IP40)	6117XX (IP40)	TN6014 (IP40)	TN6014-G (IP40)	TN6117 (IP40)
6015 (IP66/67)	6115 (IP66/67)	6024 (IP66/67)	6025 (IP66/67)	6117 (IP66/67)	6117XX (IP66/67)			
6015 (IP66/67)	6115 (IP66/67)	6024 (IP66/67)	6025 (IP66/67)	6117 (IP66/67)	6117XX (IP66/67)			

Rigid conduit

RIGID CONDUIT						
	6008-L	6110 (IP66/67)	6111 (IP66/67)	6111P (IP66/68)	6112 (IP66/67)	6117 (IP66/67)
	6008-P	6110 (IP66/67)	6111 (IP66/67)	6111P (IP66/68)	6112 (IP66/67)	6117 (IP66/67)
	6700	6110 (IP66/67)	6111 (IP66/67)	6111P (IP66/68)	6112 (IP66/67)	6117 (IP66/67)
	6700A	6110 (IP66/67)	6111 (IP66/67)	6111P (IP66/68)	6112 (IP66/67)	6117 (IP66/67)

PVC conduit

PVC CONDUIT						
		NECESSARY	OPTIONAL			
	6089	6059	6059T	6058	6057 (IP67)	
	6085	6059			6057 (IP67)	6188 (IP65)
	6079					6188 (IP65)
	6080					6188 (IP65)

6003 (IP67)	6015 (IP66/67)				
		6110-XX (IP66/67)	6111-XX (IP66/67)	6112-XX (IP66/67)	6117-XX (IP66/67)
		6110-XX (IP66/67)	6111-XX (IP66/67)	6112-XX (IP66/67)	6117-XX (IP66/67)

Protection degree of systems

Depending on the type of conduit and connector chosen will be reach differents degrees of protection, as shown on the following table:

Picture	Conduit code	IP protection degree
	667M 667DM 607T 667DXM 667DXFTX	IP40
	6071 6071E	IP44 without seal IP66/IP67 with accessory 66BTP
	6071T 6071ET 6071ETX	IP44 without seal IP66/IP67 with connector T1
	6070 607E 607D 607PU 607DBT	IP66/IP67
	607ETX	
	6008 6700 6700A	
	607X 607XX	

Assembly instructions

Instructions for cutting metallic conduit

Coated conduit



The metal conduit can be cut with hacksaw, a band saw machine or an angle grinder. To facilitate assembly of the fitting, the cut must be made vertically. Remove any burrs that might affect the coupling.

Conduit protected by metallic braid



To facilitate the cut of the conduit protected with metal braid it is recommended to apply adhesive tape near the cut point. This arrangement allows cutting the braid in an accurate manner and protect fingers during the installation of accessories.

Instruction for the installation of connector on coated conduit



1. First insert the clamping nut then the (nylon red) clamping sleeve with the truncated conical part facing towards the nut. Tighten the locking nut until it is fixed on the bushing.



2. Screw the metal virula clockwise until it stops.



3. Slide the bushing and the nut on the metal conduit until come in contact the bushing and the base of virula.



4. Insert all the elements in the body of the fitting and tighten the nut (with appropriate instruments) with torque suitable to maintain the IP degree of coupling. If necessary, insert the gasket (flat or O-ring) on the cylindrical male thread, until it stops.

Instructions for the installation of double locking connectors on conduit protected with metal braid



1. Insert the tightening nut.



2. Install the intermediate body under the braid, after removing the tape. Firmly secure the nut and the intermediate body together, thus ensuring the locking of the braid.



3. When using a conduit in a smooth coating - go to step 4.
When using a conduit with vacuum coating apply the sealing couplings 66BTP on the head of the pipe to ensure the degree of protection IP.
Note: Fold the coupling back on itself and make it fit on the conduit making sure that the inner spiral is inserted in the coils of the conduit. The ends of the conduit and the coupling must be aligned.



4. Insert the (nylon red) clamping sleeve with the truncated conical part facing towards intermediate body. Tighten the locking nut until it is fixed on the bushing.



5. Screw the metal virula clockwise until it stops.



6. Slide the bushing and the nut on the metal conduit until come in contact the bushing and the base of virula.



7. Insert all the elements in the body of the fitting and tighten the nut (with appropriate instruments) with torque suitable to maintain the IP degree of coupling.
If necessary, insert the gasket (flat or O-ring) on the cylindrical male thread, until it stops.

Conduits requested	Rigid conduit		Cond.-Cond. Connector		Cond.-Box Connector		Cond.-FThread Connector		Rigid-Flex. cond. connec.	Flexible conduit (Sleeve)			Conn. Sleeve M.Fixed		Conn. Sleeve M.swivel		Conn. Sleeve F.Fixed	
	Conduit	Guai-na	No Thread	Threadable	Gas	Metric	Gas	Metric		Gas	Metric	S. Interlocking	D. Interlocking	Gas	Metric	Gas	Metric	Gas
3/8"	6008-16L	6008-16P	6110-16N	6003-16A	6111-16N	6111-A16N	6112-16N	6112-A16N	6117-12N	6071T-012	6070-12	607D-12	6014-12	6014-16A	6014-12G	6014-1216G	6015-12	6015-12A
3/8"	6008-16L	6008-16P	6110-16N	6003-16A	6111-16N	6111-A16N	6112-16N	6112-A16N	6117-16N	6071T-016	6070-16	607D-16	6014-16	6014-1616			6015-16A	
1/2"	6008-20L	6008-20P	6110-20N	6003-20	6111-20N	6111-A20N	6112-20N	6112-A20N	6117-20N	6071T-016	6070-16	607D-16	6014-16	6014-20A	6014-16G	6014-20G	6115-012	6015-20
1/2"	6008-20L	6008-20P	6110-20N	6003-20	6111-20N	6111-A20N	6112-20N	6112-A20N	6117-2020	6071T-022	6070-22	607D-22	6014-22	6014-2020			6015-2020	
3/4"	6008-25L	6008-25P	6110-25N	6003-25	6111-25N	6111-A25N	6112-25N	6112-A25N	6117-25N	6071T-022	6070-22	607D-22	6014-22	6014-25A	6014-22G	6014-25G	6115-034	6015-25
3/4"	6008-25L	6008-25P	6110-25N	6003-25	6111-25N	6111-A25N	6112-25N	6112-A25N	6117-2527	6071T-032	6070-32	607D-32	6014-32	6014-2527			6015-2527	
1"	6008-32L	6008-32P	6110-32N	6003-32A	6111-32N	6111-A32N	6112-32N	6112-A32N	6117-32N	6071T-032	6070-32	607D-32	6014-32	6014-32A	6014-32G	6014-32G	6115-01	6015-32A
1"	6008-32L	6008-32P	6110-32N	6003-32A	6111-32N	6111-A32N	6112-32N	6112-A32N	6117-3235	6071T-038	6070-38	607D-38	6014-38	6014-3235			6015-3235	
1 1/4"	6008-40L	6008-40P	6110-40	6003-40	6111-40	6111-A40	6112-40	6112-A40	6117-4035	6071T-038	6070-38	607D-38	6014-38	6014-4035	6014-38G	6014-4035G	6115-114	6015-4035
1 1/4"	6008-40L	6008-40P	6110-40	6003-40	6111-40	6111-A40	6112-40	6112-A40	6117-40	6071T-040	6070-40	607D-40	6014-40	6014-40A			6015-40	
1 1/2"	6008-50L	6008-50P	6110-50	6003-50	6111-50	6111-A50	6112-50	6112-A50	6117-5040	6071T-040	6070-40	607D-40	6014-40	6014-5040	6014-40G	6014-5040G	6115-112	6015-5040
1 1/2"	6008-50L	6008-50P	6110-50	6003-50	6111-50	6111-A50	6112-50	6112-A50	6117-50	6071T-050	6070-50	607D-50	6014-50	6014-50A			6015-50	
2"	6008-63L	6008-63P	6110-63N	6003-63	6111-63N	6111-A63N	6112-63N	6112-A63N	6117-63N	6071T-050	6070-50	607D-50	6014-50	6014-6350	6014-50G	6014-6350G	6115-02	6015-6350
2 1/2"	6008-75L	6008-75P	6110-75	6003-75	6111-75	6111-A75	6112-75	6112-A75	6117-75			607D-63	6014-65	6014-7563	6014-65G	6014-7563G	6115-212	6015-7563
3"												607D-75	6014-75	6014-75G	6014-9075G	6115-03	6015-9075	
4"												607D-100	6014-100	6014-100G	6014-110G	6115-04	6015-110A	

The products indicated in the white row make it possible to create a OUTSIDE uniform conduit-connector system

The products indicated in the grey row make it possible to create a INSIDE uniform conduit-connector system



Characteristics of flexible metal conduit

- Compliant with 61386-1 and 61386-23;
- Made of galvanised Sendzimir steel (UNI EN 10346)
- Made of AISI 304 stainless steel (1.4301 UNI EN 10088-1)

Flame retardant material

Accessories

- Compatibility of conduit with all the accessories
- Reliable and easy installation;
- Wide range
- Nickel plated brass or stainless steel

Advantages

- Tensile strength;
- Crushing resistance;
- High flexibility

Profile type

Reinforced interlocking Simple interlocking

Double interlocking

Characteristics of metal conduit coating

Coil fixed coating

Various materials for specific applications

Type of coating:

- smooth
- vacuum

Protection degree IP66/IP67

Different colours

- Dark grey and black

The progressive length reference marking

Flame retardant coating

- Low level of toxic gas emission
- Halogen free

Resistant to oils and greases

Protection with metal braid

- Made of Sendzimir galvanised steel
- Made of AISI 304 stainless steel

Braid colour

- identifies the type of coating

Protection against electro-magnetic interference

Protection from rubbing and electric sparks

Simple interlocking - art. 667M



Characteristics:

Simple interlocking flexible conduits made from a helical ribbon of Sendzimir continuous hot-dip zinc coated strip (UNI EN 10346). They are extremely flexible and have an excellent mechanical resistance. The coils are packed in cartons. It is necessary the use of the accessory cod. **66BOTT** bushing of brass to replace the nylon bushing normally supplied on connectors

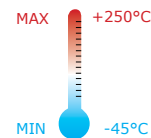
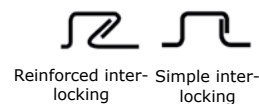
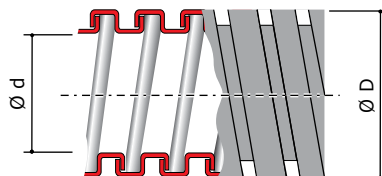

Areas of application



Classification

Standard	CEI EN 61386-1 and 61386-23
Significant classification codes CEI EN 61386-1	3 3 5 6
Protection degree in compliance with CEI EN 60529	IP40
Crushing resistance	750 N (Medium)
Impact resistance	2 J (Medium)
Tensile strength	500 N (Medium)
Suspended load capacity	450 N (Heavy)
Corrosion resistance	Medium
Electrical properties	Electrical continuity guaranteed

Internal diameter, Ø d mm	External diameter, Ø D mm	Inch dimensions	Radius of the elbow, mm	Profile	Pack, m	Code
10,0	13,0	1/4"	30		50	667M1013
12,0	15,0	3/8"	35		50	667M1215
15,5	18,5	1/2"	40		50	667M1518
20,5	24,5	3/4"	50		50	667M2024
26,5	30,0	1"	70		25	667M2630
35,0	39,5	1" 1/4	90		25	667M3539
40,0	44,5	1" 1/2	105		25	667M4044
50,5	54,5	2"	130		25	667M5054

Simple interlocking coated in smooth PVC - art. 6070



Characteristics:

Simple interlocking pliable conduits made from a helical ribbon of Sendzimir continuous hot-dip zinc coated strip (UNI EN 10346), self-extinguishing PVC, with a smooth external surface and thread fastening.

Resistant to most types of oils and greases, they are extremely flexible and have excellent levels of mechanical resistance. The progressive length reference marked on the coating surface, facilitates the cutting, and constantly updates the remaining quantity contained in the coil.

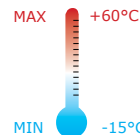
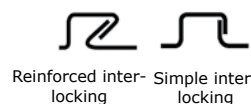
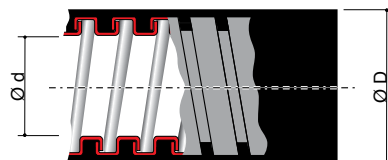

Areas of application



Colours

- Black
- Dark grey RAL 7043

Classification

Standard	CEI EN 61386-1 and 61386-22
Significant classification codes CEI EN 61386-1	3 4 3 1
Protection degree in compliance with CEI EN 60529	IP66 / IP 67
Crushing resistance	1250 N (Heavy) until cod. 6070-32 - 750 N (Medium) from cod. 6070-38
Impact resistance	6 J (Heavy)
Tensile strength	500 N (Medium) until cod. 6070-16 - 1000 N (Heavy) from cod. 6070-22 and 6070-R
Suspended load capacity	450 N (Heavy)
Self-extinguishing CEI EN 61386	Flame retardant
Electrical properties	Electrical continuity guaranteed
Compliance and certifications	CEI EN 61386 IMQ n° CA.0205671 CEI EN 61386 RINA n° ELE272314CS

Certification	Internal diameter, Ø d mm	External diameter, Ø D mm	Inch dimensions	Radius of the elbow, mm	Profile	Pack, m	Grey code	Black code
	10,0	15,0	1/4"	50		50	6070-10	6070-10N
	12,0	18,0	3/8"	60		50	6070-12	6070-12N
	15,5	21,0	1/2"	70		50	6070-16	6070-16N
	20,5	27,0	3/4"	90		50	6070-22	6070-22N
	26,5	34,0	1"	120		25	6070-32	6070-32N
	35,0	43,0	1" 1/4	150		25	6070-38	6070-38N
	40,0	48,0	1" 1/2	200		25	6070-40	6070-40N
	50,5	58,5	2"	250		25	6070-50	6070-50N
	10	15	1/4"	60		50	* 6070-10R	-
	12	18	3/8"	70		50	* 6070-12R	-
	15,5	21	1/2"	80		50	* 6070-16R	-

* Available on request for minimum quantities

Simple interlocking coated in smooth EVA - art. 607E



Characteristics:

Pliable conduits made from Sendzimir galvanised steel ribbon (UNI EN 10346 Standard), with helioidal profile and simple interlocking.

The coating is made of thermoplastic EVA which is a flame retardant material with a low level of toxic and corrosive gas emission, halogen-free, with a smooth external surface and thread fastening. Resistant to common oils and grease and have good flexibility and good mechanical resistance.

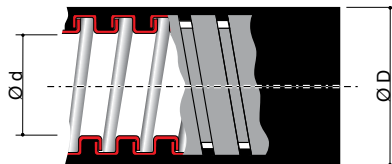

Certification reports

- LAPI** Laboratorio Prevenzione Incendi srl:
- No.1181.0DC0030/11 in compliance with EN ISO 11925-2
 - No.1181.5AF0010/11 in compliance with NF X 10-702-1
 - No.1181.5AF0020/11 in compliance with NF X 70-100-1
 - No.1181.5AF0030/11 in compliance with NF F 16-101
 - No.1045-1046/15 in compliance with UNI CEI EN 45545-2:2013

Areas of application



Colours

- Black: (on request)
- Dark grey



Reinforced interlocking Simple interlocking

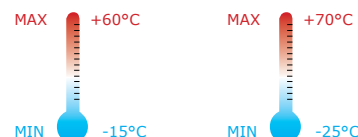

Temperature referred to system conduit-connector IMQ certify

* Available on request for minimum quantities

Classification

Standard	CEI EN 61386-1 and 61386-22, UNI CEI 11170-3, UNI CEI EN 45545-2:2013
Significant classification codes CEI EN 61386-1	3 4 3 1
Protection degree in compliance with CEI EN 60529	IP66 / IP 67
Compression resistance	1250 N (Heavy) until cod. 607E032, 750 N (Medium) from cod. 607E038
Impact resistance	6 J (Heavy)
Traction resistance	500 N (Medium) until cod. 607E016, 1000 N (Heavy) from cod. 607E022 and 607E..R
Suspended load capacity	450 N (Heavy)
Self-extinguishing CEI EN 61386	Flame retardant
Fume emission in compliance with NF F 16-101	F1
Electrical properties	Electrical continuity guaranteed
Compliance and certifications	CEI EN 61386 IMQ n° CA.0205671 CEI EN 61386 RINA n° ELE272314CS UNI CEI 11170-3 LAPI LR4 UNI CEI EN 45545-2:2013 HL2 per R22/R23

Certification	Internal diameter, Ø d mm	External diameter, Ø D mm	Inch dimensions	Radius of the elbow, mm	Profile	Pack, m	Grey code	Black code (on request)
	10,0	15,0	1/4"	60		50	607E010	607E010N
	12,0	18,0	3/8"	70		50	607E012	607E012N
	15,5	21,0	1/2"	90		50	607E016	607E016N
	20,5	27,0	3/4"	120		50	607E022	607E022N
	26,5	34,0	1"	140		25	607E032	607E032N
	35,0	43,0	1" 1/4	190		25	607E038	607E038N
	40,0	48,0	1" 1/2	240		25	607E040	607E040N
	50,5	58,5	2"	300		25	607E050	607E050N
	10	15	1/4"	70		50	* 607E010R	-
	12	18	3/8"	80		50	* 607E012R	-
	15,5	21	1/2"	100		50	* 607E016R	-

Simple interlocking coated in smooth EVA and protected by stainless steel banding art. 607ETX



Characteristics:

Pliable conduits made from Sendzimir galvanised steel ribbon (UNI EN 10346 Standard), with helicoidal profile and simple interlocking. The coating is made of thermoplastic EVA which is a flame retardant material with a low level of toxic and corrosive gas emission, halogen-free, with a smooth external surface and thread fastening.

They are protected by an AISI 304 stainless steel metal braid, that renders the conduit highly resistant to wear, abrasion and electric sparks. These conduits are resistant to common oils and grease and have good flexibility and good mechanical resistance.

They also offer good protection against electromagnetic interference across a large wave band.

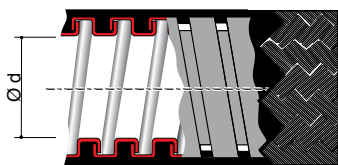

Certification reports

- LAPI** Laboratorio Prevenzione Incendi srl:
- No.1181.0DC0030/11 in compliance with EN ISO 11925-2
 - No.1181.5AF0010/11 in compliance with NF X 10-702-1
 - No.1181.5AF0020/11 in compliance with NF X 70-100-1
 - No.1181.5AF0030/11 in compliance with NF F 16-101
 - No.1045-1046/15 in compliance with UNI CEI EN 45545-2:2013

Areas of application

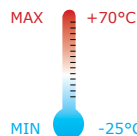

Braid colours

No references



Reinforced interlocking Simple interlocking

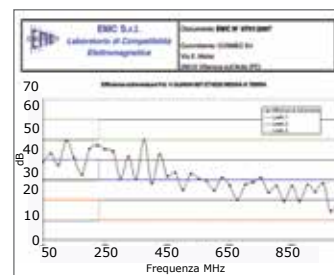

Classification

Standard	CEI EN 61386-1 and 61386-22, UNI CEI 11170-3, UNI CEI EN 45545-2:2013
Significant classification codes CEI EN 61386-1	3 4 4 1
Protection degree in compliance with CEI EN 60529	IP66 / IP67
Compression resistance	1250 N (Heavy) until cod. 607ETX032 - 750 N (Medium) from cod. 607ETX038
Impact resistance	6 J (Heavy)
Traction resistance	500 N (Medium) until cod. 607ETX016 - 1000 N (Heavy) from cod. 607ETX022
Suspended load capacity	450 N (Heavy)
Self-extinguishing CEI EN 61386	Flame retardant
Fume emission in compliance with NF F 16-101	F1
EMC Shielding in compliance with IEC TS 61587: 30-230MHz	Level 1 (Minimum abatement. 35dB)
Electrical properties	Electrical continuity guaranteed and insulation properties
Compliance and certifications	UNI CEI 11170-3 LAPI LR4 UNI CEI EN 45545-2:2013 HL2 per R22/R23

Internal diameter, Ø d mm	External diameter, Ø D mm	Inch dimensions	Radius of the elbow, mm	Profile	Pack, m	Code
10,0	17,0	1/4"	60		50	607ETX010
12,0	20,0	3/8"	70		50	607ETX012
15,5	23,0	1/2"	90		50	607ETX016
20,5	29,0	3/4"	120		50	607ETX022
26,5	35,0	1"	140		25	607ETX032
35,0	44,0	1" 1/4	190		25	607ETX038
40,0	49,0	1" 1/2	240		25	607ETX040
50,5	60,0	2"	300		25	607ETX050

Simple interlocking coated in vacuum PVC - art. 6071

Characteristics:

Simple interlocking pliable conduits made from a helical ribbon of Sendzimir continuous hot-dip zinc coated strip (UNI EN 10346), vacuum self-extinguishing PVC. Resistant to most types of oils and greases, they are extremely flexible and have excellent levels of mechanical resistance.

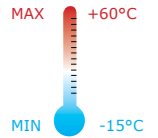
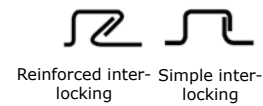
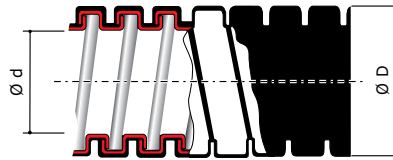
Areas of application

Colours

- Black (on request)
- Dark grey

Classification

Standard	CEI EN 61386-1 and 61386-22
Significant classification codes CEI EN 61386-1	3 4 3 1
Protection degree in compliance with CEI EN 60529	IP44 - IP66/67 with accessory 66BTP
Compression resistance	1250 N (Heavy) until cod. 6071-027 - 750 N (Medium) from cod. 6071-035
Impact resistance	6 J (Heavy)
Traction resistance	500 N (Medium) until cod. 6071-015 - 1000 N (Heavy) from cod. 607E1-020
Suspended load capacity	450 N (Heavy)
Self-extinguishing CEI EN 61386	Flame retardant
Electrical properties	Electrical continuity guaranteed and insulation properties
Compliance and certifications	CEI EN 61386 IMQ n° CA.0205672 CEI EN 61386 RINA n° ELE272314CS

Certification	Internal diameter, Ø d mm	External diameter, Ø D mm	Inch dimensions	Radius of the elbow, mm	Profile	Pack, m	Grey code	Black code (on request)
	10,0	14,0	1/4"	30		50	6071-010	6071-010N
	12,0	16,0	3/8"	35		50	6071-012	6071-012N
	15,5	19,5	1/2"	40		50	6071-015	6071-015N
	20,5	25,5	3/4"	60		50	6071-020	6071-020N
	26,5	31,5	1"	80		25	6071-027	6071-027N
	35,0	41,0	1" 1/4	120		25	6071-035	6071-035N
	40,0	46,0	1" 1/2	150		25	6071-040	6071-040N
	50,5	56,0	2"	200		25	6071-050	6071-050N

Simple interlocking coated in vacuum PVC protected by metal braid

art. 6071T



Characteristics:

Simple interlocking pliable conduits made from a helical ribbon of Sendzimir continuous hot-dip zinc coated strip (UNI EN 10346), self-extinguishing PVC protected by galvanised steel braid that provides high resistance against wear. Resistant to most types of oils and greases, they are extremely flexible and have excellent levels of mechanical resistance. They offer a good protection from electromagnetic interferences in a large wave band.

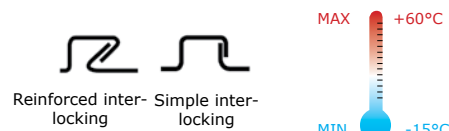
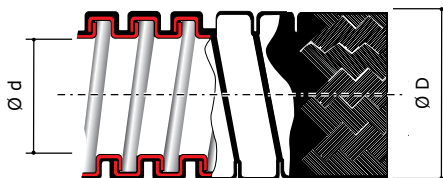

Areas of application



Braid colours

Blue

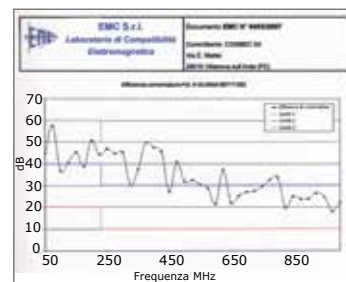

Classification

Standard	CEI EN 61386-1 and 61386-22
Significant classification codes CEI EN 61386-1	3 4 3 1
Protection degree in compliance with CEI EN 60529	IP44 - IP66/67 with connectors T1
Compression resistance	1250 N (Heavy) until a cod. 6071T-032 - 750 N (Medium) from cod. 6071T-038
Impact resistance	6 J (Heavy)
Traction resistance	500 N (Medium) until cod. 6071T-016 - 1000 N (Heavy) from cod. 6071T-022
Suspended load capacity	450 N (Heavy)
Self-extinguishing CEI EN 61386	Flame retardant
EMC shielding in compliance with IEC TS 61587: 30-230MHz	Level 1 (Minimum abatement 35dB)
Electrical properties	Electrical continuity guaranteed

Internal diameter, Ø d mm	External diameter, Ø D mm	Inch dimensions	Radius of the elbow, mm	Profile	Pack, m	Code
10,0	16,0	1/4"	30		50	6071T-010
12,0	18,0	3/8"	35		50	6071T-012
15,5	21,0	1/2"	50		50	6071T-016
20,5	27,0	3/4"	65		50	6071T-022
26,5	33,0	1"	80		25	6071T-032
35,0	42,0	1" 1/4	120		25	6071T-038
40,0	47,0	1" 1/2	150		25	6071T-040
50,5	58,0	2	220		25	6071T-050

Simple interlocking coated in vacuum EVA - art. 6071E

Characteristics:

Pliable conduits made from Sendzimir galvanised steel ribbon (UNI EN 10346 Standard), with helicoidal profile and simple interlocking. The coating is made of vacuum thermoplastic EVA which is a flame retardant material with a low level of toxic and corrosive gas emission, halogen-free. These conduits are resistant to common oils and grease and have good flexibility and good mechanical resistance.

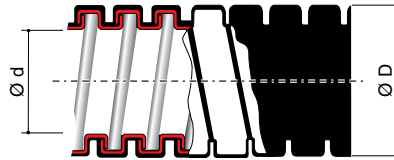
Certification reports

- LAPI** Laboratorio Prevenzione Incendi srl:
- No.1181.0DC0030/11 in compliance with EN ISO 11925-2
 - No.1181.5AF0010/11 in compliance with NF X 10-702-1
 - No.1181.5AF0020/11 in compliance with NF X 70-100-1
 - No.1181.5AF0030/11 in compliance with NF F 16-101
 - No.1044.11S0040/15 in compliance with UNI CEI EN 45545-2:2013

Areas of application

Colours

- Black (on request)
- Dark grey



Reinforced interlocking Simple interlocking

MAX +60°C



MIN -15°C

MAX +70°C



MIN -25°C

Temperature referred to system conduit-connector IMQ certify

Classification

Standard	CEI EN 61386-1 and 61386-22, UNI CEI 11170-3:2005
Significant classification codes CEI EN 61386-1	3 4 4 1
Protection degree in compliance with CEI EN 60529	IP44
Compression resistance	1250 N (Heavy) until cod. 6071E-027, 750 N (Medium) from cod. 6071E-035
Impact resistance	6 J (Heavy)
Traction resistance	500 N (Medium) until cod. 6071E-015, 1000 N (Heavy) from cod. 6071E-020
Suspended load capacity	450 N (Heavy)
Self-extinguishing in accordance CEI EN 61386	Flame retardant
Fume Emission in compliance with NF F 16-101	F1
Electrical properties	Electrical continuity guaranteed and insulation properties
Compliance and certifications	CEI EN 61386 IMQ n° CA.0205672 CEI EN 61386 RINA n° ELE272314CS UNI CEI 11170-3 LAPI LR4 UNI CEI EN 45545-2:2013 HL3 per R22/R23

Certification	Internal diameter, Ø d mm	External diameter, Ø D mm	Inch dimensions	Radius of the elbow, mm	Profile	Pack, m	Grey code	Black code (on request)
	10,0	14,0	1/4"	30		50	6071E-010	6071E-010N
	12,0	16,0	3/8"	35		50	6071E-012	6071E-012N
	15,5	19,5	1/2"	50		50	6071E-015	6071E-015N
	20,5	25,5	3/4"	65		50	6071E-020	6071E-020N
	26,5	31,5	1"	80		25	6071E-027	6071E-027N
	35,0	41,0	1" 1/4	120		25	6071E-035	6071E-035N
	40,0	46,0	1" 1/2	150		25	6071E-040	6071E-040N
	50,5	56,0	2"	220		25	6071E-050	6071E-050N

Simple interlocking coated in vacuum EVA and protected by metal braid art. 6071ETX-6071ET



Characteristics:

Pliable conduits made from Sendzimir galvanised steel ribbon (UNI EN 10346 Standard), with helicoidal profile and simple interlocking. The coating is made of vacuum thermoplastic EVA which is a flame retardant material with a low level of toxic and corrosive gas emission and halogen-free. They are protected by a galvanised steel braid (cod. 6071ET) or AISI 304 stainless steel (cod. 6071ETX), that renders the conduit highly resistant to wear, abrasion and electric sparks. These conduits are resistant to common oils and grease and have good flexibility and good mechanical resistance. They also offer good protection against electromagnetic interference across a large wave band.

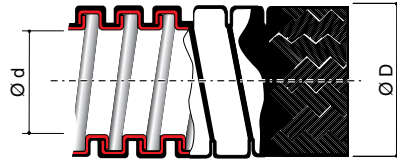

Certification reports

- LAPI** Laboratorio Prevenzione Incendi srl:
- No.1181.0DC0030/11 in compliance with EN ISO 11925-2
 - No.1181.5AF0010/11 in compliance with NF X 10-702-1
 - No.1181.5AF0020/11 in compliance with NF X 70-100-1
 - No.1181.5AF0030/11 in compliance with NF F 16-101
 - No.1044.1IS0040/15 in compliance with UNI CEI EN 45545-2:2013

Areas of application

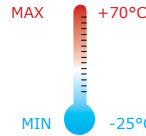

Reinforced interlocking Simple interlocking

- Braid colours**
- No references
 - Galvanised green

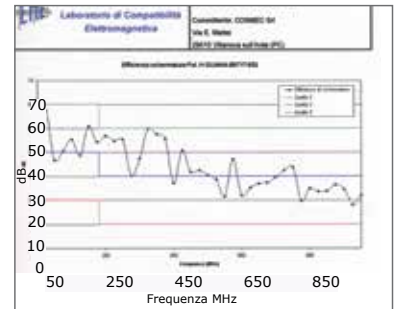

Classification

Standard	CEI EN 61386-1 and 61386-22, UNI CEI 1170-3:2005
Significant classification codes CEI EN 61386-1	3 4 4 1
Protection degree in compliance with CEI EN 60529	IP44 - IP66/67 with connectors T1
Compression resistance	1250 N (Heavy) until cod. 6071E-032 - 750 N (Medium) from cod. 6071E-038
Impact resistance	6 J (Heavy)
Traction resistance	500 N (Medium) until cod. 6071E-016 - 1000 N (Heavy) from cod. 6071E-022
Suspended load capacity	450 N (Heavy)
Self-extinguishing in accordance CEI EN 61386	Flame retardant
Fume Emission in compliance with NF F 16-101	F1
Electrical properties	Electrical continuity guaranteed and insulation properties
EMC Shielding in compliance with IEC TS 61587: 30-230 MHZ	Level 1 (Minimum abatement 35dB)
Compliance and certifications	UNI CEI 11170-3 LAPI LR4 UNI CEI EN 45545-2:2013 HL3 per R22/R23

Internal diameter, Ø d mm	External diameter, Ø D mm	Inch dimensions	Radius of the elbow, mm	Profile	Pack, m	Galvanised steel braid code	Stainless steel braid code
10,0	16,0	1/4"	30		50	6071ET-010	6071ETX-010
12,0	18,0	3/8"	35		50	6071ET-012	6071ETX-012
15,5	21,0	1/2"	50		50	6071ET-016	6071ETX-016
20,5	27,0	3/4"	65		50	6071ET-022	6071ETX-022
26,5	33,0	1"	80		25	6071ET-032	6071ETX-032
35,0	42,0	1" 1/4	120		25	6071ET-038	6071ETX-038
40,0	47,0	1" 1/2	150		25	6071ET-040	6071ETX-040
50,5	58,0	2"	220		25	6071ET-050	6071ETX-050

Simple interlocking protected by galvanised steel braided - art. 607T

Characteristics:

Flexible conduits made from Sendzimir hot-dip galvanised (UNI EN 10346:2009) helical strip with simple or reinforced interlocking (ref. in table). The conduits are protected by galvanised steel braided sleeving.

They provide excellent flexibility and good mechanical resistance together with good protection against electro-magnetic interference.

They are used in industrial applications where a high level of thermal resistance is required, with TN connectors the system is without any plastic materials.

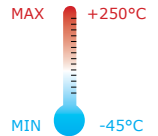
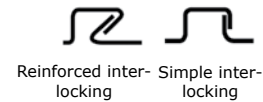
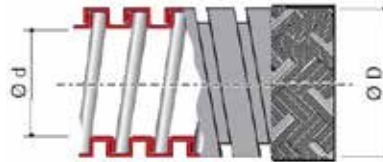
Areas of application

Braid colours

No references

Classification

Standard	CEI EN 61386-1 and 61386-23
Significant classification codes CEI EN 61386-1	3 3 5 6
Protection degree in compliance with CEI EN 60529	IP40
Compression resistance	750 N (Medium)
Impact resistance	2 J (Medium)
Corrosion resistance	2 (Medium)
Electrical properties	Electrical continuity guaranteed
EMC shielding in accordance with IEC TS 61587:30 - 230MHz	Level 1 (minimum abatement 35dB)

Internal diameter, $\varnothing d$ mm	External diameter, $\varnothing D$ mm	Inch dimensions	Radius of the elbow, mm	Profile	Pack, m	Code
10,0	15,5	1/4"	30		50	* 607T-10
12,0	17,5	3/8"	35		50	* 607T-12
15,5	21,0	1/2"	40		50	* 607T-16
20,5	26,0	3/4"	50		50	* 607T-20
26,5	33,0	1"	70		25	* 607T-27
35,0	41,5	1" 1/4	90		25	* 607T-35
40,0	47,0	1" 1/2	105		25	* 607T-40
50,5	58,0	2"	130		25	* 607T-50

*Available on request for minimum quantities

Double interlocking - art. 667DM



Characteristics:

Flexible conduits made from ribbon of hot-dip galvanised Sendzimir (UNI EN 10346) helical double interlocking.

They are extremely flexible and have an excellent mechanical resistance particularly when subjected to stress resulting from traction, torsion and impact.

The coils are packed in cartons.

It is necessary the use of the accessory cod. **66BOTT** bushing of brass to replace the nylon bushing normally supplied on connectors.

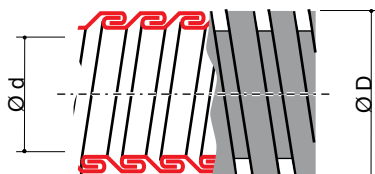

Double interlocking

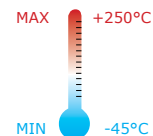

Areas of application



Classification

Standard	CEI EN 61386-1 and 61386-23
Significant classification codes CEI EN 61386-1	4 4 5 6
Protection degree in compliance with CEI EN 60529	IP40
Compression resistance	1250 N (Heavy)
Impact resistance	6 J (Heavy)
Tensile strenght	1000 N (Heavy)
Suspended load capacity	450 N (Heavy)
Corrosion resistance	Medium
Electrical properties	Electrical continuity guaranteed

Internal diameter, Ø d mm	External diameter, Ø D mm	Inch dimensions	Radius of the elbow, mm	Profile	Pack, m	Code
10,0	13,0	1/4"	50		50	667DM10
12,0	15,0	3/8"	55		50	667DM12
15,5	18,5	1/2"	60		50	667DM15
20,5	24,5	3/4"	90		50	667DM20
26,5	30,0	1"	110		25	* 667DM26
35,0	39,0	1" 1/4	130		25	* 667DM35
40,0	44,0	1" 1/2	160		25	* 667DM40
50,5	54,5	2	200		25	* 667DM50
63,0	67,5	2" 1/2	300		12	* 667DM63
75,0	79,5	3"	350		8	* 667DM75
100,0	104,5	4"	460		8	* 667DM100

*Available on request for minimum quantities

Stainless steel AISI 304 double interlocking - art. 667DXM

Characteristics:

Double interlocking flexible conduits made from a helical ribbon of stainless steel AISI 304 (X5 CrNi1810 1.4301 UNI EN 10088-1).

They are extremely flexible and have an excellent mechanical resistance particularly when subjected to stress resulting from traction, torsion and impact. Designed particularly for use in harsh chemical environments. The coils are packed in cartons.

It is necessary the use of the accessory cod. **66BOTT** bushing of brass to replace the nylon bushing normally supplied on connectors.

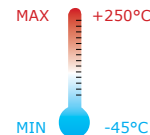
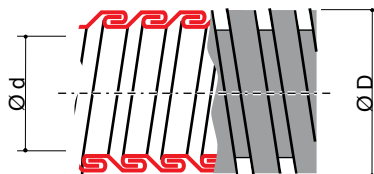
Areas of application

Classification

Standard	CEI EN 61386-1 and 61386-23
Significant classification codes CEI EN 61386-1	4 4 5 6
Protection degree in compliance with CEI EN 60529	IP40
Compression resistance	1250 N (Heavy)
Impact resistance	6 J (Heavy)
Tensile strength	1000 N (Heavy)
Suspended load capacity	450 N (Heavy)
Corrosion resistance	4 High
Electrical properties	Electrical continuity guaranteed

Internal diameter, Ø d mm	External diameter, Ø D mm	Inch dimensions	Radius of the elbow, mm	Profile	Pack, m	Code
10,0	13,0	1/4"	50		50	* 667DXM10
12,0	15,0	3/8"	55		50	* 667DXM12
15,5	18,5	1/2"	60		50	* 667DXM16
20,5	24,5	3/4"	90		50	* 667DXM20
26,5	30,0	1"	110		25	* 667DXM26
35,0	39,0	1" 1/4	130		25	* 667DXM35
40,0	44,0	1" 1/2	160		25	* 667DXM40
50,5	54,5	2	200		25	* 667DXM50

*Available on request for minimum quantities

Double interlocking coated in smooth PVC - art. 607D



Characteristics:

Pliable conduits made from a helical ribbon of Sendzimir continuous hot-dip zinc coated strip (UNI EN 10346 standard), and externally coated in smooth and self-extinguishing PVC. Resistant to most types of oils and greases, they present a good flexibility and a really good mechanical resistance when subjected to traction stresses.

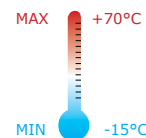
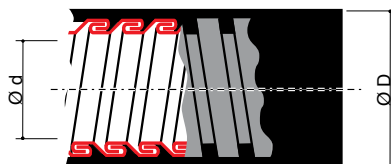

Areas of application

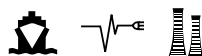

Colours

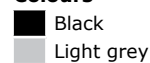

Classification

Standard	CEI EN 61386-1 and 61386-22
Significant classification codes CEI EN 61386-1	4 4 3 1
Protection degree in compliance with CEI EN 60529	IP66 / IP67
Compression resistance	1250 N (Heavy)
Impact resistance	6 J (Heavy)
Tensile strength	1000 N (Heavy)
Suspended load capacity	450 N (Heavy)
Self-extinguishing CEI EN 61386	Flame retardant
Electrical properties	Electrical continuity guaranteed

Internal diameter, Ø d mm	External diameter, Ø D mm	Inch dimensions	Radius of the elbow, mm	Profile	Pack, m	Grey Code	Black code
10,0	15,0	1/4"	60		50	607D-10	607D-10N
12,0	18,0	3/8"	70		50	607D-12	607D-12N
15,5	21,0	1/2"	90		50	607D-16	607D-16N
20,5	27,0	3/4"	120		50	607D-22	607D-22N
26,5	34,0	1"	140		25	607D-32	607D-32N
35,0	43,0	1" 1/4	190		25	607D-38	607D-38N
40,0	48,0	1" 1/2	240		25	607D-40	607D-40N
50,5	58,5	2"	300		25	607D-50	607D-50N
63,0	74,0	2" 1/2	450		12	607D-63	607D-63N
75,0	84,0	3"	500		8	607D-75	607D-75N
100,0	109,0	4"	750		8	607D-100	607D-100N

Double interlocking coated in smooth polyurethane - art. 607PU

Characteristics:

Pliable conduits made from Sendzimir galvanised steel ribbon (UNI EN 10346 Standard), with heli-coidal profile and double interlocking.
 The coating is made of polyuretane with a low level of toxic and corrosive gas emission, halogen-free, with a smooth external surface and thread fastening.
 These conduits are resistant to inks, synthetic oils and grease and have excellent flexibility and really good mechanical resistance when subjected to traction stresses.
 Resistant to UV light, abrasion and corrosion, even at very low temperatures, these conduits are well suited to outdoor applications.

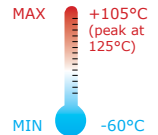
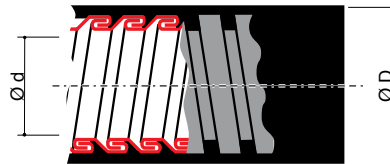
Areas of application

Colours

■ Black

Classification

Standard	CEI EN 61386-1 and 61386-22, UNI CEI 11170-3:2005
Significant classification codes CEI EN 61386-1	4 4 5 3
Protection degree in compliance with CEI EN 60529	IP66 / IP67
Compression resistance	1250 N (Heavy)
Impact resistance	6 J (Heavy)
Tensile strength	1000 N (Heavy)
Suspended load capacity	450 N (Heavy)
Self-extinguishing CEI EN 61386	Flame retardant
Fume Emission in compliance with NF F 16-101	F1
Electrical properties	Electrical continuity guaranteed and insulation properties

Internal diameter, Ø d mm	External diameter, Ø D mm	Inch dimensions	Radius of the elbow, mm	Profile	Pack, m	Code
10,0	15,0	1/4"	60		50	607PU10N
12,0	18,0	3/8"	70		50	607PU12N
15,5	21,0	1/2"	90		50	607PU16N
20,5	27,0	3/4"	120		50	607PU22N
26,5	34,0	1"	140		25	607PU32N
35,0	43,0	1" 1/4	190		25	607PU38N
40,0	48,0	1" 1/2	240		25	607PU40N
50,5	58,5	2"	300		25	607PU50N

Double interlocking coated in smooth TPV - art. 607DBT



Characteristics:

Double interlocking pliable conduits made from a helical ribbon of Sendzimir (UNI EN 10346 Standard), and externally coated in smooth and self-extinguishing TPV. Resistant to most types of oils and greases, they present a good flexibility and a really good mechanical resistance when subjected to traction stresses. Suitable for applications in harsh environmental conditions, especially for use at low temperatures.

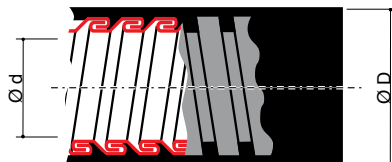

Double interlocking

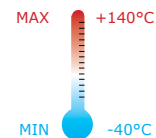

Areas of application

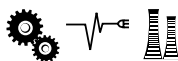

Colours

Black

Classification

Standard	CEI EN 61386-1 and 61386-22
Significant classification codes CEI EN 61386-1	4 4 4 4
Protection degree in compliance with CEI EN 60529	IP66 / IP67
Compression resistance	1250 N (Heavy)
Impact resistance	6 J (Heavy)
Tensile strength	1000 N (Heavy)
Suspended load capacity	450 N (Heavy)
Self-extinguishing CEI EN 61386	Flame retardant
Electrical properties	Electrical continuity guaranteed and insulation properties

Internal diameter, Ø d mm	External diameter, Ø D mm	Inch dimensions	Radius of the elbow, mm	Profile	Pack, m	Code
20,5	27,0	3/4"	90		50	607DBT22
26,5	34,0	1"	110		25	607DBT32
35,0	43,0	1" 1/4	130		25	607DBT38
40,0	48,0	1" 1/2	160		25	607DBT40
50,5	58,5	2	200		25	607DBT50
63,0	74,0	2" 1/2	300		12	607DBT63
75,0	84,0	3"	350		8	607DBT75
100,0	109,0	4"	460		8	607DBT100

Stainless steel double interlocking coated with fibre glass and stainless steel braid art. 667DXFTX

Characteristics:

Flexible conduits made from stainless steel AISI 304 (X5CrNi1810 1.4301 UNI EN 100881) helical strip with double interlocking. Enclosed in a fibre glass braided sleeving covered by an AISI 304 stainless steel braided sleeving. Designed to provide excellent flexibility and optimum mechanical resistance, especially against strain caused by traction, torsion and impact. They offer good protection against electro-magnetic interference. Ideal for use in industrial applications where high thermal and mechanical resistance is required. Resistant to oils, solvents and many chemical agents. With TN connectors the system is without any plastic materials.

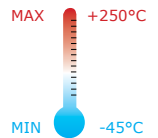
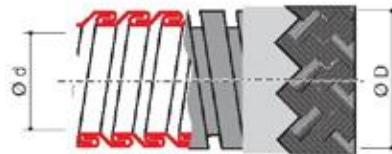
Areas of application

Braid colours

No references

Classification

Standard	CEI EN 61386-1 and 61386-23
Significant classification codes CEI EN 61386-1	4 4 5 6
Protection degree in compliance with CEI EN 60529	IP40
Compression resistance	1250 N (Heavy)
Impact resistance	6 J (Heavy)
Corrosion resistance	4 High int./ext.
Electrical properties	Electrical continuity guaranteed and insulation properties
EMC shielding in accordance with IEC TS 61587:30 - 230Mhz	Level 1 (minimum abatement 35dB)

Internal diameter, Ø d mm	External diameter, Ø D mm	Inch dimensions	Radius of the elbow, mm	Profile	Pack, m	Code
15,5	21,5	1/2"	60		50	* 667DXFTX16
20,5	26,5	3/4"	75		50	* 667DXFTX22
26,5	35,0	1"	100		50	* 667DXFTX32
35,0	42,5	1" 1/4	130		25	* 667DXFTX38
40,0	48,0	1" 1/2	160		10	* 667DXFTX40
50,5	59,0	2"	195		10	* 667DXFTX50

*Available on request for minimum quantities

Bendable stainless steel - art. 607X and 607XX



Characteristics:

AISI 321 (X6CrNiTi 1811 1.4541 UNI EN10088-1) or AISI 316L (X2CrNiMo17-12-2 1.4404 UNI EN 10088-1) corrugated bendable conduits, designed particularly for use in harsh chemical environments. These conduits can also be used in conditions where the bendability of rigid metal piping proves difficult.

High levels of resistance to crushing. Both the internal and external surfaces are corrugated and this allows a cable to slide through extremely easily during feeding.

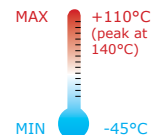
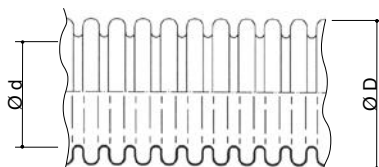

Areas of application



Classification

Standard	CEI EN 61386-1 and 61386-22
Significant classification codes CEI EN 61386-1	5 5 5 4
Protection degree in compliance with CEI EN 60529	IP67 with accessory cod. 6060X
Compression resistance	4000 N (Very Heavy)
Impact resistance	20 J (Very Heavy)
Tensile strength	2500 N (Very Heavy)
Suspended load capacity	450 N (Heavy)
Electrical properties	Electrical continuity guaranteed

Internal diameter, Ø d, (Ø nominal) mm	External diameter, Ø D mm	Radius of the elbow, mm	Pack, m	AISI 321 Code	AISI 316 L Code
12,8 (12,0)	17,7	25	15	607X-12	607XX-12
16,7 (15,5)	22,2	30	15	607X-16	607XX-16
20,7 (20,5)	27,1	35	15	607X-22	607XX-22
25,6 (25,6)	33,2	40	15	607X-32	607XX-32
32,6 (35,0)	42,0	50	15	607X-38	607XX-38

Kit for bendable stainless steel conduits Cod. 6060X



The kit consisting of two nickel plated brass half cylinders appropriately shaped so that they can be inserted into the corrugation of the conduit that prevents it from sliding, and a flat seal that guarantees its water tightness. The kit can be fitted onto any type of connector for metal flexible conduits, to replace the bushing and the base normally supplied as standard.

Conduit Ø d, (Ø nominal) mm	Pack/pcs	Code
12,8 (12,0)	20	6060X-12
16,7 (15,5)	20	6060X-16
20,7 (20,5)	20	6060X-22
25,6 (25,6)	20	6060X-32
32,6 (35,0)	20	6060X-38

Glass fiber braided with silicone coating - art. 60HT

Characteristics:

Silicone sleeve made in braid manufactured from E-fiberglass yarn then coated in red silicone (1mm thickness). Since it is manufactured by a unique process, it is extremely flexible, easily conforms to shapes and profiles, adapting itself to tubes and cables in close-fitting way. It finds ready application as an insulation and/or protective covering in a variety of industries wherever else a high temperature barrier might be required.

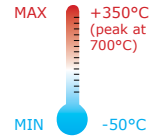
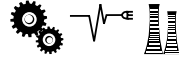
Areas of application

Classification

Standard	UL 1441 VW-I
Protection degree in compliance with CEI EN 60529	IP66 / IP68
Exposure up to 1090° C	15-20 minutes
Exposure up to 1650° C	15-30 seconds
Self-extinguishing CEI EN 61386	Flame retardant

Bendable conduit, Ø d, mm	Pack, m	Code
10	20	60HT-10
12	20	60HT-12
15	20	60HT-15
20	20	60HT-20
25	20	60HT-25
30	20	60HT-30
35	20	60HT-35
38	20	60HT-38
40	20	60HT-40
42,5	20	60HT-42
45	15	60HT-45
51	15	60HT-51
60	15	60HT-60
65	15	60HT-65
70	15	60HT-70
75	15	60HT-75
80	15	60HT-80
85	15	60HT-85
90	15	60HT-90
100	15	60HT-100
115	10	60HT-115



Smooth PVC flexible conduits protected by a metal braiding - art. 6089



Characteristics:

PVC flexible conduits having an excellent resistance to most oils, greases and diluted acids and in particular to ageing.
Protected with a braid of steel wire that offers high levels of protection against wear and tear.
Standard braiding: galvanised steel wire.

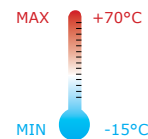

Areas of application



Braid colours



Classification

Standard	CEI EN 61386-1 and 61386-23
Significant classification codes CEI EN 61386-1	0 2 3 1
Protection degree	IP67 in compliance with CEI EN 60529 (IEC 529 Standard)
Working temperature	From -15° C to +70 °C
Impact resistance	1 J (Light)
Self-extinguishing CEI EN 61386	Flame retardant

Internal diameter, Ø d mm	External diameter, Ø D mm	Radius of the elbow, mm	Pack, m	Code
10	15,5	25	50	6089-10
12	17,5	30	50	6089-12
15	21,5	40	50	6089-15
20	26,5	50	50	6089-20
27	35,0	70	25	6089-28
36	45,0	110	25	6089-35
40	50,0	130	25	6089-40

Smooth PVC conduits - art. 6085

Characteristics:

PVC flexible conduits, resistant to most oils, greases and diluted acids and in particular to ageing. Both internal and external surfaces are smooth.

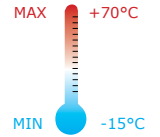
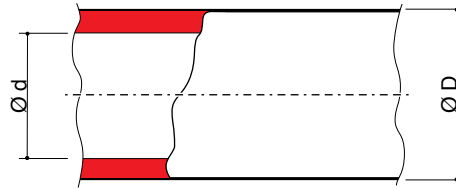
Areas of application

Colours

- Black (on request)
- Dark grey
- Blue

Classification

Standard	CEI EN 61386-1 and 61386-23
Significant classification codes CEI EN 61386-1	0 2 3 1
Protection degree in compliance with CEI EN 60529	IP65 / IP67
Impact resistance	1 J (Light)
Self-extinguishing CEI EN 61386	Flame retardant

Internal diameter, Ø d mm	External diameter, Ø D mm	Pack, m	Grey code	Blue code	Black code (on request)
10	14	50	6085-10	6085-10A	6085-10N
12	16	50	6085-12	6085-12A	6085-12N
15	20	50	6085-15	6085-15A	6085-15N
20	26	50	6085-20	6085-20A	6085-20N
27	34	25	6085-27	6085-27A	6085-27N
36	43	25	6085-36	6085-36A	6085-36N
40	48	25	6085-40	6085-40A	6085-40N

Heavy helical PVC conduits - art. 6079



Characteristics:

Extra thick, plasticized PVC flexible conduits, reinforced with rigid, impact-resistant helical PVC. Resistant to most oils, greases and diluted acids and in particular to ageing. Both internal and external surfaces are smooth.

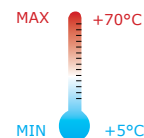
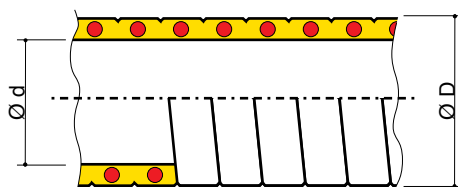

Areas of application



Colours

Grey RAL 7001

Classification

Standard	CEI EN 61386-1 and 61386-23
Significant classification codes CEI EN 61386-1	2 3 1 1
Protection degree in compliance with CEI EN 60529	IP65
Compression resistance	320 N (Light)
Impact resistance	2 J (Medium)
Self-extinguishing CEI EN 61386	Flame retardant

Internal diameter, Ø d mm	External diameter, Ø D mm	Radius of the elbow, mm	Pack, m	Code
10	14,0	40	30	6079-10B
12	16,4	55	30	6079-12B
16	20,7	70	30	6079-16B
20	24,7	80	30	6079-20B
28	33,5	90	30	6079-28B
35	41,0	120	30	6079-35B
40	46,4	140	30	6079-40B
50	57,2	160	30	6079-50B

Helical PVC conduits - art. 6080

Characteristics:

PVC plasticized flexible conduits, reinforced with rigid, impact-resistant helical PVC. Resistant to most oils, greases and diluted acids and in particular to ageing. Internal surfaces are smooth and external surfaces are corrugated.

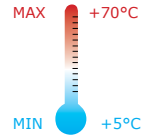
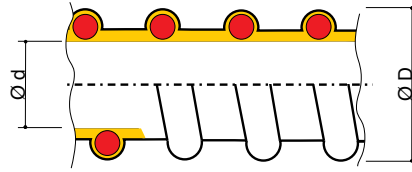
Areas of application

Colours

- Black (on request)
- RAL 7035 Grey

Classification

Standard	CEI EN 61386-1 and 61386-23
Significant classification codes CEI EN 61386-1	1 3 1 1
Protection degree in compliance with CEI EN 60529	IP65
Compression resistance	120 N (Very light)
Impact resistance	2 J (Medium)
Self-extinguishing CEI EN 61386	Flame retardant

Internal diameter, Ø d mm	External diameter, Ø D mm	Radius of the elbow, mm	Pack, m	Grey code	Black code (on request)
10	14,7	30	30	6080-10B	6080-10N
12	16,4	35	30	6080-12B	6080-12N
16	20,7	45	30	6080-16B	6080-16N
20	24,7	60	30	6080-20B	6080-20N
25	30,6	70	30	6080-25B	6080-25N
32	38,0	90	30	6080-32B	6080-32N
40	46,4	110	30	6080-40B	6080-40N
50	57,2	135	30	6080-50B	6080-50N

Characteristics of connectors for flexible and bendable metal conduits

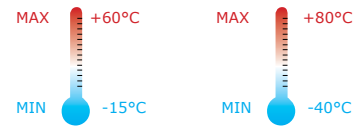
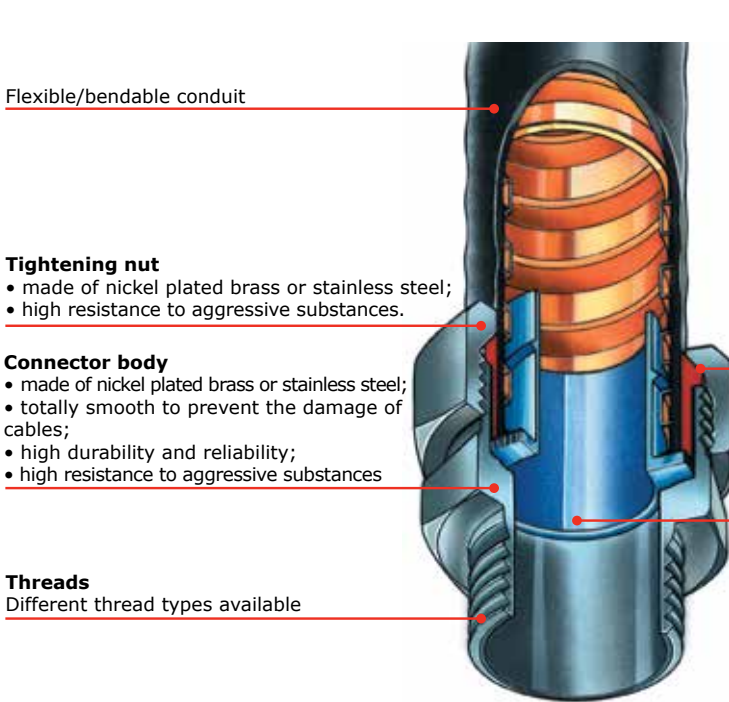

The temperature is referred to conduit - connector assembly certified as per IMQ

Nylon locking bushing

- The particular truncated conical shape guarantee the external locking of conduit, providing IP66/IP67 seal

Galvanised zamak metallic contact base

- Protection against possible damage of cables;
- screwed inside the conduit, ensures a high tensile strength and electrical continuity

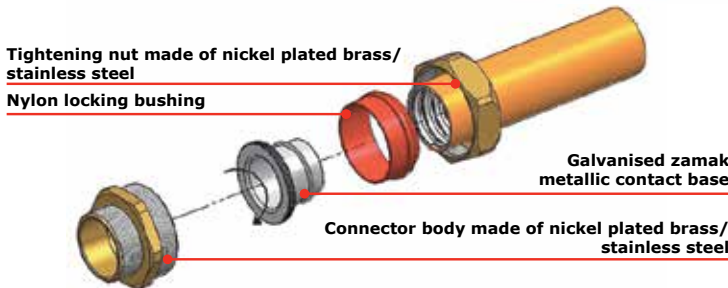

Characteristics:

Are made of nickel plated brass or in AISI 316L stainless steel (X2CrNiMo 17-12-2 1.4404 UNI EN 10088-1). The connection connector-flexible conduit is made by means of a base that is screwed into the conduit in order to guarantee both high levels of resistance against traction and electrical continuity as required by CEI standards. The external locking of the flexible conduit is ensured by a nylon truncated conical shaped bushing that guarantees an IP66/IP67 rating water tightness. To cope with different installation requirements, the following types are produced: fixed male, swivel male and fixed female. Suggested threads are: ISO metric in compliance with CEI EN 60423 (IEC60423), UNI ISO 228 GAS cylindrical, ISO 7/1 (ex UNI339) GAS tapered, PG in accordance with DIN 40430, and with an NP ANSI B2.1 thread. Being manufactured with a particular care and attention these connectors ensure a perfect fitting of cables without any risk of coating damage.

Classification

Standard	CEI EN 61386
Protection degree in compliance with CEI EN 60529	IP66/IP67 (for connector with threads >2" IP65)
Working temperature	from -15° C to +60° C (IMQ) from -40° C to +80°C
Tensile strength	1000 N (Heavy)
Suspended load capacity	450 N (Heavy)
Corrosion resistance	2 (Medium) brass - 4 (high) stainless steel
Compliance and certifications	CEI EN 61386 IMQ n° CA.0205671 - CA.0205672 CEI EN 61386 RINA n° ELE272314CS
Electrical properties	Electrical continuity guaranteed

Picture	Code	IP protection degree
	Cod. 667M Cod. 667DM Cod. 607T Cod. 667DXM Cod. 667DXFTX + 66BOTT	IP40
	Cod. 6070 Cod. 607E Cod. 607D Cod. 607PU Cod. 607DBT	IP66/IP67
	Cod. 607ETX	IP66/IP67
	Cod. 6071 Cod. 6071E	IP44 without seal IP66/IP67 with connector 66BTP
	Cod. 6071T Cod. 6071ETX Cod. 6071ET	IP44 without seal IP66/IP67 with connector T1
	Cod. 607X Cod. 607XX + 6060X	IP66/IP67

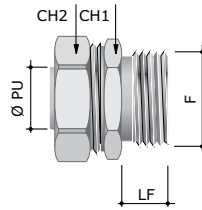
Fixed male connector - art. 6014

Characteristics:

- Material: nickel plated brass;
- Working temperature: from -15° to +60 ° C (IMQ system), from -40°C to + 80° C;
- Must be used with flexible and bendable metal conduit.

Metric

Certification	Flexible conduit Ø d, mm	Dimensions, mm					Pack/pcs.	Code	
		F	Ø PU	CH 1	CH 2	LF			
		10	M16 x 1,5	8,5	22	24	10	20	6014-1016
		12	M16 x 1,5	10,0	24	26	10	50	6014-16A
		15,5	M16 x 1,5	12,0	28	30	10	40	6014-1616
		15,5	M20 x 1,5	13,8	28	30	10	40	6014-20A
		20,5	M20 x 1,5	16,0	35	37	10	20	6014-2020
		20,5	M25 x 1,5	18,0	35	37	12	20	6014-25A
		26,5	M25 x 1,5	20,0	42	45	12	15	6014-2527
		26,5	M32 x 1,5	24,0	42	45	13	15	6014-32A
		40	M40 x 1,5	34,0	58	61	18	5	6014-40A
		35	M40 x 1,5	32,0	50	52	10	5	6014-4035
		50,5	M50 x 1,5	44,0	70	74	18	5	6014-50A
		40	M50 x 1,5	38,0	58	61	18	5	6014-5040
		50,5	M63 x 1,5	48,0	70	74	18	1	6014-6350

PG

Flexible conduit Ø d, mm	Dimensions, mm					Pack/pcs.	Code
	F	Ø PU	CH 1	CH 2	LF		
10	07	8,5	22	24	9	50	6014-07
10	09	8,5	22	24	9	10	6014-1009
10	11	8,5	22	24	9	10	6014-1011
10	13	8,5	22	24	9	10	6014-1013
12	09	10	24	26	9	10	6014-09
12	11	10	24	26	9	10	6014-11
12	13,5	10	24	26	9	50	6014-1213
12	16	10	24	26	9	10	6014-1215
15,5	13,5	13,8	28	30	10	50	6014-13
15,5	16	13,8	28	30	9	50	6014-15
20,5	16	16	35	37	9	10	* 6014-1520
20,5	21	18	35	37	9	20	6014-21
26,5	29	24	42	45	12	15	6014-29
35	36	32	50	52	12	10	6014-36
40	42	38	58	61	18	5	6014-42
50,5	48	48	70	74	18	5	6014-48

* On request for minimum quantities

ISO 228 GAS Cylindrical

Flexible conduit Ø d, mm	Dimensions, mm					Pack/pcs.	Code
	F	Ø PU	CH 1	CH 2	LF		
10	1/4"	8,5	22	24	8,5	50	6014-10
10	3/8"	8,5	22	24	8,5	10	6014-1038
12	3/8"	10	24	26	8,5	50	6014-12
12	1/2"	10	24	26	8,5	50	6014-1212
15,5	1/2"	13,8	28	30	10	50	6014-16
20,5	3/4"	18	35	37	12	20	6014-22
26,5	1"	24	42	45	13	15	6014-32
35	1" 1/4	32	50	52	14	10	6014-38
35	1" 1/2	32	50	52	10	10	* 6014-381
40	1" 1/2	38	58	61	18	5	6014-40
50,5	2"	48	70	74	18	5	6014-50
63	2" 1/2	59,5	94	94	26	1	6014-65
75	3"	71	104	104	25	1	6014-75
100	4"	95	129	129	30	1	6014-100

NPT

Flexible conduit Ø d, mm	Dimensions, mm					Pack/pcs.	Code
	F	Ø PU	CH 1	CH 2	LF		
15,5	1/2"	13,8	28	30	13,5	50	* 6014-16NPT
20,5	3/4"	18	35	37	14,5	20	* 6014-22NPT
26,5	1"	24	42	45	19	15	* 6014-32NPT
35	1" 1/4	32	50	52	19	10	* 6014-38NPT
40	1" 1/2	38	58	61	20,5	5	* 6014-40NPT
50,5	2"	48	70	74	22	5	* 6014-50NPT
63	2" 1/2	59,5	94	94	26	1	* 6014-65NPT
75	3"	71	104	104	25	1	* 6014-75NPT
100	4"	95	129	129	30	1	*6014-100NPT

ISO 7/1 GAS Tapered

Flexible conduit Ø d, mm	Dimensions, mm					Pack/pcs.	Code
	F	Ø PU	CH 1	CH 2	LF		
15,5	1/2"	13,8	28	30	13,5	30	* 6014-16I7
20,5	3/4"	18	35	37	14,5	20	* 6014-22I7
26,5	1"	24	42	45	19	15	* 6014-32I7
35	1" 1/4	32	50	52	20,5	10	* 6014-38I7
40	1" 1/2	38	58	61	20,5	5	* 6014-40I7
50,5	2"	48	70	74	22	5	* 6014-50I7
63	2" 1/2	59,5	94	94	26	1	* 6014-65I7
75	3"	71	104	104	25	1	* 6014-75I7
100	4"	95	129	129	30	1	* 6014-100I7

* On request for minimum quantities

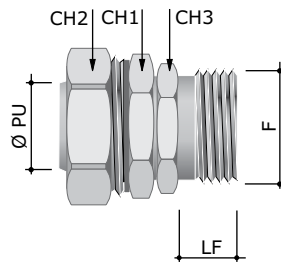
Swivel male connector - art. 6014-G

Characteristics:

- Material: nickel plated brass;
- Working temperature: from -15° to +60 ° C (IMQ system), from -40°C to + 80° C;
- Must be used with flexible and bendable metal conduit
- Swivel element protected by an O-ring seal inside of connector.

Metric

Certification	Flexible conduit Ø d, mm	Dimensions, mm						Pack/pcs	Code	
		F	Ø PU	CH 1	CH 2	CH 3	LF			
		10	M16x1,5	8,5	22	24	20	10	30	6014-1016G
		12	M16x1,5	10,0	24	26	22	10	30	6014-1216G
		15,5	M20x1,5	13,8	28	30	26	10	10	6014-20G
		20,5	M25x1,5	18,0	35	37	32	10	20	6014-25G
		26,5	M32x1,5	24,0	42	45	39	13	10	6014-2732G
		35	M40x1,5	32,0	50	52	50	14	7	6014-4035G
		40	M50x1,5	38,0	58	61	55	18	5	6014-5040G
		50,5	M63x1,5	48,0	70	74	70	18	1	6014-6350G

PG

Flexible conduit Ø d, mm	Dimensions, mm						Pack/pcs	Code
	F	Ø PU	CH 1	CH 2	CH 3	LF		
12	09	10	24	26	22	10	30	6014-09G
10	09	8,5	22	24	20	9	30	*6014-1009G
12	11	10	24	26	22	10	30	6014-11G
12	13,5	10	24	26	22	10	30	6014-1213G
15,5	13,5	13,8	28	30	26	10	30	6014-13G
15,5	16	13,8	28	30	26	10	30	6014-15G
20,5	21	18	35	37	32	13	20	6014-21G
26,5	29	24	42	45	40	13	10	6014-29G
35	36	32	50	52	50	14	7	6014-36G
40	42	38	58	61	55	18	5	6014-42G
50,5	48	48	70	74	70	18	5	6014-48G

ISO 228 GAS Cylindrical

Flexible conduit Ø d, mm	Dimensions, mm						Pack/pcs	Code
	F	Ø PU	CH 1	CH 2	CH 3	LF		
10	1/4"	8,5	22	24	20	9	30	*6014-10G
10	3/8"	8,5	22	24	20	9	30	6014-1038G
12	3/8"	10	24	26	22	10	30	6014-12G
12	1/2"	10	24	26	22	10	50	6014-1212G
15,5	1/2"	13,8	28	30	26	10	30	6014-16G
20,5	3/4"	18	35	37	32	10	20	6014-22G
26,5	1"	24	42	45	39	13	15	6014-32G
35	1" 1/4	32	50	52	50	14	7	6014-38G
40	1" 1/2	38	58	61	55	18	5	6014-40G
50,5	2"	48	70	74	70	18	5	6014-50G
63	2" 1/2	59,5	94	94	86	25	1	6014-65G
75	3"	71	104	104	96	25	1	6014-75G
100	4"	95	129	129	121	28	1	6014-100G

NPT

Flexible conduit Ø d, mm	Dimensions, mm						Pack/pcs	Code
	F	Ø PU	CH 1	CH 2	CH 3	LF		
15,5	1/2"	13,8	28	30	26	13,5	30	* 6014-16NG
20,5	3/4"	18	35	37	32	14,5	20	* 6014-22NG
26,5	1"	24	42	45	39	19	10	* 6014-32NG
35	1" 1/4	32	50	52	50	20,5	5	* 6014-38NG
40	1" 1/2	38	58	61	55	20,5	5	* 6014-40NG
50,5	2"	48	70	74	70	22	1	* 6014-50NG
63	2" 1/2	59,5	94	94	86	25	1	* 6014-65NG
75	3"	71	104	104	96	25	1	* 6014-75NG
100	4"	95	129	129	121	28	1	* 6014-100NG

ISO 7/1 GAS Tapered

Flexible conduit Ø d, mm	Dimensions, mm						Pack/pcs	Code
	F	Ø PU	CH 1	CH 2	CH 3	LF		
15,5	1/2"	13,8	28	30	26	13,5	30	* 6014-16IG
20,5	3/4"	18	35	37	32	14,5	20	* 6014-22IG
26,5	1"	24	42	45	39	19	10	* 6014-32IG
35	1" 1/4	32	50	52	50	20,5	5	* 6014-38IG
40	1" 1/2	38	58	61	55	20,5	5	* 6014-40IG
50,5	2"	48	70	74	70	22	1	* 6014-50IG
63	2" 1/2	59,5	94	94	86	25	1	* 6014-65IG
75	3"	71	104	104	96	25	1	* 6014-75IG
100	4"	95	129	129	121	28	1	* 6014-100IG

* on request for minimum quantity

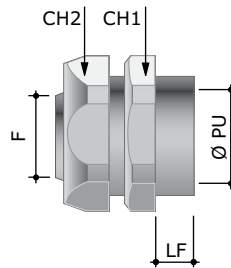
Fixed female connector - art. 6015 and 6115

Classification:

Manufactured in compliance with CEI EN 61386-1 Standards
IMQ Approval Certificate: EM568

Characteristics:

Connection fittings necessary to couple rigid metal threadable conduits, part no. 6008-P, to metal flexible and bendable conduits.
Working temperature: from -15° to +60 ° C (IMQ systems), from -40°C to + 80° C.

Metric

Certifications	Flexible conduit Ø d, mm	Dimensions, mm					Pack/pcs.	Code	
		F	Ø PU	CH 1	CH 2	LF			
		10	M16 x 1,5	8,5	22	24	12	20	6015-10A
		12	M16 x 1,5	10,0	24	26	13	10	6015-12A
		15,5	M16 x 1,5	13,8	28	30	14,5	50	6015-16A
		15,5	M20 x 1,5	13,8	28	30	14,5	50	6015-20
		20,5	M20 x 1,5	18,0	35	37	14	20	6015-2020
		20,5	M25 x 1,5	18,0	35	37	16	20	6015-25
		26,5	M25 x 1,5	23,0	42	45	16	15	6015-2527
		26,5	M32 x 1,5	24,0	42	45	16	15	6015-32A
		35	M32 x 1,5	30,0	50	52	17	10	6015-3235
		35	M40 x 1,5	32,0	50	52	17	15	6015-40
		40	M40 x 1,5	38,0	58	61	20	5	6015-4035
		40	M50 x 1,5	38,0	58	61	23	5	6015-50
		50,5	M50 x 1,5	48,0	70	74	20,5	5	6015-5040
		50,5	M63 x 1,5	48,0	70	74	45	1	6015-6350

GAS ISO 228

Flexible conduit Ø d, mm	Dimensions, mm					Pack/pcs.	Code
	F	Ø PU	CH 1	CH 2	LF		
10	3/8"	8,5	22	24	11	50	6015-10
12	3/8"	10	24	26	11	10	* 6015-12
15,5	3/8"	13,8	28	30	13	50	6015-16
15,5	1/2"	13,8	28	30	14,5	50	6115-12
20,5	3/4"	18	35	37	13	20	6115-34
26,5	1"	24	42	45	14	15	6115-01
35	1" 1/4	32	50	52	13	10	6115-114
40	1" 1/2	38	58	61	20	5	6115-112
50,5	2"	48	70	74	20	1	6115-02
63	2" 1/2	59,5	94	94	26	1	6115-212
75	3"	71	104	104	28	1	6115-03
100	4"	95	129	129	30	1	6115-04

AISI 316L stainless steel fixed male connector - art. 6014XX

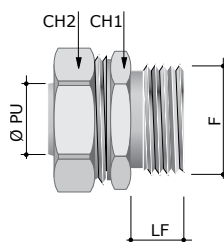

Characteristics:

Made in AISI 316L stainless steel (X2CrNi-Mo17-12-2 1.4404 UNI EN10088-1), to be used in situations where traditional nickel plated brass fittings are considered to be insufficiently resistant to the environmental conditions.

The operating characteristics are identical to Cod. 6014. nickel-plated brass fittings.

Type produced: fixed male.

The thread is ISO Metric and complies with CEI EN 60423.

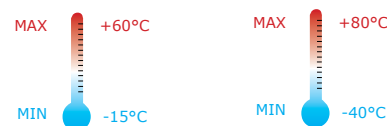

The temperature is referred to conduit - connector assembly certified as per IMQ

Classification

Standard	CEI EN 61386-1
Tensile strength	1000 N (Heavy)
Suspended load capacity	450 N (Heavy)
Corrosion resistance	4 (High)
Compliance and certifications	CEI EN 61386 IMQ n° CA.0205671 - CA.0205672 CEI EN 61386 RINA n° ELE272314CS

Metric

Certification	Flexible conduit Ø d, mm	Dimensions, mm					Pack/pcs.	Code
		F	Ø PU	CH 1	CH 2	LF		
	12	M16 x 1,5	10	27	27	9	25	6014XX16A
	15,5	M16 x 1,5	12	30	30	10	25	6014XX1616
	15,5	M20 x 1,5	13,8	30	30	10	20	6014XX20A
	20,5	M20 x 1,5	16	36	36	10	20	6014XX2020
	20,5	M25 x 1,5	18	36	36	12	25	6014XX25A
	26,5	M32 x 1,5	24	46	46	13	15	6014XX32A
	35	M40 x 1,5	32	50	55	14	5	6014XX4035
	40	M50 x 1,5	38	58	60	18	5	6014XX5040

Connector glands for metal flexible conduits - art. 6014P

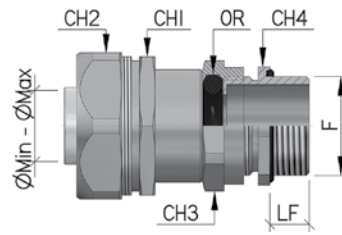

The temperature is referred to conduit - connectors assembly certified as per IMQ

Classification:

Produced in compliance with the following standards: CEI EN 61386 and CEI EN 50262
Protection degree in accordance with EN 60529: IP66/IP68

Requirements of use:

They are designed for use when it becomes necessary giving the water tightness to the system.

Characteristics:

Made of nickel plated brass. The operating characteristics are identical to cod. 6014. These special fittings include an glands adapter with a metric male threaded heads.

The thread is ISO METRIC and complies with CEI EN 60423

Metric

Certifications	Flexible conduit Ø d, mm	Tightening ØMin ØMax	Dimensions, mm						Pack/ pcs.	Code	
			F	CH 1	CH 2	CH 3	CH 4	LF			
		10	05 ÷ 09	M 12x1,5	22,0	24	20	20	10	30	6014P10M120509
		10	05 ÷ 09	M 16x1,5	22,0	24	20	20	10	30	6014P10M160509
		10	08 ÷ 12	M 20x1,5	22,0	24	24	24	10	30	6014P10M200812
		12	05 ÷ 09	M 12x1,5	24,0	26	20	20	10	30	6014P12M120509
		12	05 ÷ 09	M 16x1,5	24,0	26	20	20	10	30	6014P12M160509
		12	08 ÷ 12	M 20x1,5	24,0	26	24	24	10	30	6014P12M200812
		15,5	05 ÷ 09	M 12x1,5	28,0	30	20	20	10	30	6014P16M120509
		15,5	05 ÷ 09	M 16x1,5	28,0	30	20	20	10	30	6014P16M160509
		15,5	08 ÷ 12	M 20x1,5	28,0	30	24	24	10	30	6014P16M200812
		15,5	11 ÷ 16	M 25x1,5	28,0	30	30	30	10	20	6014P16M251116
		20,5	08 ÷ 12	M 20x1,5	35,0	37	24	24	10	20	6014P22M200812
		20,5	11 ÷ 16	M 20x1,5	35,0	37	30	30	10	20	6014P22M201116
		20,5	11 ÷ 16	M 25x1,5	35,0	37	30	30	10	20	6014P22M251116
		20,5	15 ÷ 21	M 32x1,5	35,0	37	36	36	10	10	6014P22M321521
		26,5	11 ÷ 16	M 20x1,5	42,0	45	30	30	10	10	6014P32M201116
		26,5	11 ÷ 16	M 25x1,5	42,0	45	30	30	10	10	6014P32M251116
		26,5	15 ÷ 21	M 25x1,5	42,0	45	36	36	10	10	6014P32M251521
		26,5	15 ÷ 21	M 32x1,5	42,0	45	36	36	10	10	6014P32M321521
		26,5	20 ÷ 27	M 40x1,5	42,0	45	45	45	12	10	6014P32M402027
		35	15 ÷ 21	M 32x1,5	50,0	52	36	36	10	7	6014P38M321521
		35	20 ÷ 27	M 40x1,5	50,0	52	45	45	12	7	6014P38M402027
		40	20 ÷ 27	M 40x1,5	58,0	61	45	45	12	5	6014P40M402027

Elbow connectors for metal flexible conduits



art. 6024
connector bent to 45°

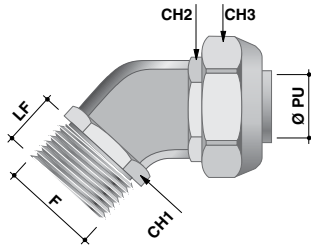

Classification:

Manufactured in compliance with CEI EN 61386 System protection rating in compliance with EN 60529: IP66/IP67. Electrical properties: Electrical continuity guaranteed.

Characteristics:

Made of brass which is then nickel plated in order to improve resistance to the harsh environmental conditions in which they are used.

Part no. 6024 bent to 45°, Part no. 6025 bent to 90° is produced by coupling two perfectly aligned 45° elbows, and an o-ring seal that guarantees its tightness. The use of these fittings is in order to achieve a correct application of flexible conduits, which will avoid bending and twisting that would damage the conduits as well as the cables housed within. It also results in a reduction of cable clutter. Produced with ISO Metric thread in compliance with CEI EN 60423.



art. 6025
connector bent to 90°

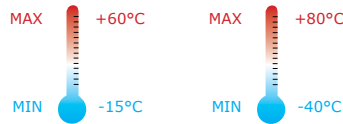

The temperature is referred to conduit - connectors assembly certified as per IMQ

Metric

Certification	Flexible conduit Ø d, mm	Dimensions, mm						Pack/ pcs.	Code 45°	Code 90°	
		F	Ø PU	CH 1	CH 2	CH 3	LF				
		10	M16 x 1,5	8,5	19	22	24	10	10	6024-1610	6025-1610
		12	M16 x 1,5	10,0	19	24	26	10	10	6024-1612	6025-1612
		15,5	M16 x 1,5	11,5	19	28	30	10	10	6024-1616	6025-1616
		15,5	M20 x 1,5	13,8	23	28	30	10	10	6024-2016	6025-2016
		20,5	M20 x 1,5	15,0	23	35	37	10	10	6024-2020	6025-2020
		20,5	M25 x 1,5	18,0	28	35	37	10	10	6024-2520	6025-2520
		26,5	M25 x 1,5	20,0	28	42	45	10	10	6024-2527	6025-2527
		26,5	M32 x 1,5	24,0	36	42	45	10	10	6024-3227	6025-3227

Double locking connectors for metal conduits protected by braided sleeving

The connectors ensure double locking of the conduit and the protective metal braid sleeving. All connectors are made of nickel plated brass.

This solution has a number of advantages:

- Excellent resistance to traction;
- High IP rating with all types of conduit coatings;
- Prevents piercing caused by accidental contact with the end of the sleeving;
- Braid sleeving held securely around the whole circumference.

Tightening nut

- Made of nickel plated brass;
- high resistance to aggressive substances;
- high resistance to tensile strength and suspended load capacity.

Nylon locking bushing

- The particular truncated conical shape; guarantees the external locking of conduit, providing IP66/IP67 seal.

Connector body

- Made of nickel plated brass;
- totally smooth to prevent the damage of cables;
- high durability and reliability;
- high resistance to aggressive substances.

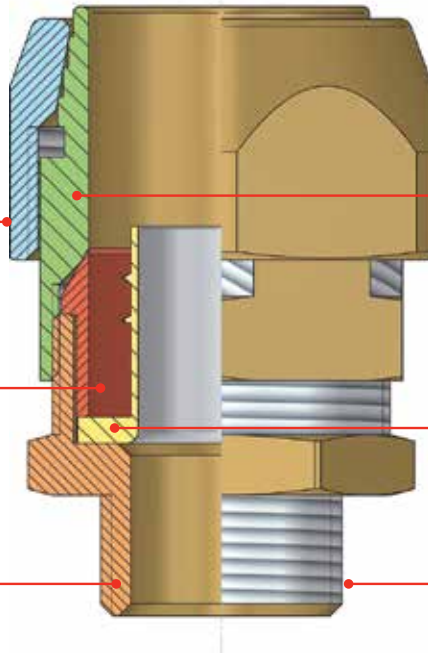

Intermediate body

- Made of nickel plated brass;
- high mechanical resistance;
- high resistance to aggressive substances;
- braid sleeving held securely around the whole circumference.

Galvanised zamak metallic contact base

- Protection against possible damage of cables;
- screwed inside the conduit, ensures a high tensile strength and electrical continuity.

Thread

Different thread types available.



	T0	T1	TN
Connector version			
Coating version	Conduits with SMOOTH plastic coating	Conduits with VACUUM plastic coating	Conduits WITH NO plastic coating
Conduits	 607ETX	 6071T 6071ET 6071ETX	 607T 667DXFTX
IP protection degree	IP66/IP67	IP66/IP67	IP40
Working temperature	 MAX +70°C MIN -25°C	 MAX +70°C MIN -25°C	 MAX +250°C MIN -45°C

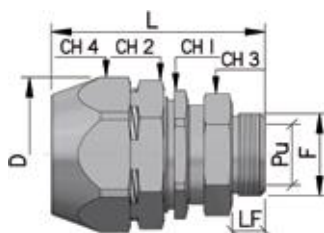

Swivel male double locking connector - art. T_6014-G

Characteristics:

Connectors made from nickel plated brass which ensure double locking of the conduit and the protective metal braid sleeving. This technical solution has a number of strong points:

- Excellent resistance to traction;
- High IP rating with all types of conduit coatings;
- Prevents piercing caused by accidental contact with the end of the sleeving;
- Braid sleeving held securely around the whole circumference.

Some of the versions on offer:

- T0 for conduits with smooth plastic coating
- T1 for conduits with vacuum plastic coating
- TN for conduits with no plastic coating

Standard	CEI EN 61386-1, 61386-22, 61386-23 and CEI EN 60423
Working temperature	T0 and T1 = -25°C +70°C TN = -45°C +250°C
Protection degree of system (CEI EN 60529)	T0 and T1 = IP66 / IP67 TN = IP44
Electrical properties	Electrical continuity guaranteed for EMC

Metric

Flexible conduit Ø d, mm	Dimensions, mm									kg/ pcs.	Pack pcs.	Code Version	Article version
	F	Ø PU	CH 1	CH 2	CH 3	CH 4	LF	L	D				
10,0	M16 x 1,5	8,5	22	26	22	28	10	58,5	31	0,128	30	T0 T1 + TN	6014-1016G
12,0	M16 x 1,5	10,0	24	28	22	30	10	59,5	34	0,139	30		6014-1216G
15,5	M20 x 1,5	13,8	28	30	26	35	10	64,5	35	0,200	10		6014-20G
20,5	M25 x 1,5	18,0	35	39	32	42	10	67,0	47	0,296	10		6014-25G
26,5	M32 x 1,5	24,0	42	50	39	50	13	75,5	56	0,468	10		6014-2732G
35,0	M40 x 1,5	32,0	50	55	50	60	14	76,0	64	0,648	7		6014-4035G
40,0	M50 x 1,5	38,0	58	60	55	65	18	87,5	72	0,766	5		6014-5040G
50,5	M63 x 1,5	48,0	70	80	65	80	18	93,5	87	1,321	1		6014-6350G

	T0	T1	TN
Connector version			
Coating version	Conduits with SMOOTH plastic coating	Conduits with VACUUM plastic coating	Conduits WITH NO plastic coating

Caution:

Enter the code which identifies the version (T0/T1/TN) in front of the code of the standard connector.

Ex.: version T1 code + connector 6014-25A code gives the overall code T16014-25A

Types available: male fixed, male swivel and rigid/flexible conduit, with metric ISO thread in compliance with Standard CEI EN 60423; upon request, for minimum batch sizes, it is possible to create all the variables already available for our flexible conduit connectors.

* Some weights are theoretical and may vary slightly from the values given in the table.

Fixed male double locking connectors - art. T_6014

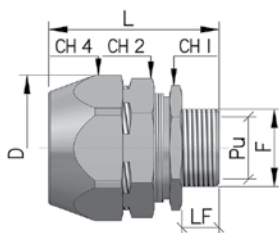

Metric

Flexible conduit Ø d, mm	F	Ø PU	CH 1	CH 2	CH 4	LF	L	D	kg/pcs.*	Pack/ pcs.	Code Version	Article version
10,0	M16 X 1,5	8,5	22	26	28	9	44	31	0,094	20	T0 T1 + TN	6014-1016
12,0	M16 X 1,5	10,0	24	28	30	9	45	34	0,107	50		6014-16A
15,5	M20 X 1,5	13,8	28	30	35	10	51	39	0,164	25		6014-20A
20,5	M20 X 1,5	16,0	35	39	42	10	54	47	0,236	10		6014-2020
20,5	M25 X 1,5	18,0	36	39	42	12	56	47	0,247	10		6014-25A
26,5	M32 X 1,5	24,0	42	50	50	12	61	56	0,392	10		6014-32A
35,0	M40 X 1,5	32,0	50	55	60	14	61	64	0,498	5		6014-4035
40,0	M40 X 1,5	34,0	58	60	65	14	66	72	0,578	5		6014-40A
40,0	M50 X 1,5	38,0	58	60	65	18	70	72	0,609	5		6014-5040
50,5	M50 X 1,5	44,0	70	80	80	18	75	76	0,998	5		6014-50A
50,5	M63 X 1,5	48,0	70	80	80	18	75	76	1,083	1	6014-6350	

Double locking connectors for rigid conduit - flexible conduit - art. T_6117

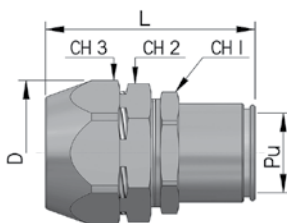

Metric

Flexible conduit Ø d, mm	Rigid conduit Ø D, mm	Ø PU	CH 1	CH 2	CH 3	L	D	kg/ pcs.*	Pack/ pcs.	Code Version	Article version
10,0	16,0	8,5	24	26	28	60	31	0,120	25	T0 T1 + TN	6117-10N
12,0	16,0	10,0	24	28	30	61	34	0,130	25		6117-12N
15,5	16,0	13,8	28	30	35	65	39	0,180	25		6117-16N
20,5	20,0	18,0	35	39	42	65	47	0,270	15		6117-2020
20,5	25,0	18,0	35	39	42	68	47	0,270	15		6117-25N
26,5	32,0	24,0	42	50	50	77	56	0,425	10		6117-32N
35,0	32,0	32,0	50	55	60	76	64	0,510	5		6117-3235
35,0	40,0	32,0	50	55	60	81	72	0,592	5		6117-4035
40,0	40,0	38,0	60	60	65	85	72	0,685	5		6117-40
40,0	50,0	38,0	58	60	65	85	76	0,696	5		6117-5040
50,5	50,0	48,0	70	80	80	87	76	1,089	5	6117-50	

Caution:

Enter the code which identifies the version (T0/T1/TN) in front of the code of the standard connector.

* Some weights are theoretical and may vary slightly from the values given in the table.

Universal connector for PVC flexible conduits - art. 6188



Characteristics:

These connectors commonly referred to as universal, because in addition to the possibility of their being used on different types of flexible conduits they can also be used as fixed or swivelling, depending on requirements.

Made of PVC they consist of a body with cogged elastic sections, a clamping nut and a threaded end fitting, which, in addition to swivelling, can also become fixed through the fitting of a small axial extension.

The conduit is coupled to the connector by tightening the nut on the body of the connector. This will cause the elastic section to deform, blocks the conduit, and results in a perfect mechanical seal. The particular care and attention that goes into producing these connectors ensures a perfect fitting of cables without any risk of coating damage.

Suggested threads are: ISO metric in compliance with CEI EN 60423, UNI ISO 228 GAS cylindrical and PG in accordance with DIN 40430. Metric and GAS type threaded connectors are supplied with a locknut.

Colours



RAL 7001
Grey



Black
on request



RAL 7035 Grey
on request

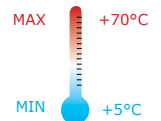

Classification

Standard	CEI EN 61386
Self-extinguishing in accordance with CEI EN 61386	Flame retardant
Protection degree	IP65 in accordance CEI EN 60529 (IEC 529 Standard)

Metric with locknut

Flexible conduit Ø d, mm	Dimensions, mm		Pack/pcs	RAL 7001 Code	Black Code	RAL 7035 Code
	F	Ø PU				
10	M12 x 1,5	8	50	-	6188-1012N	6188-1012B
12	M16 x 1,5	10	50	-	6188-1216N	6188-1216B
15-16	M20 x 1,5	13	50	6188-1520G	6188-1520N	6188-1520B
20	M25 x 1,5	18	50	-	6188-2025N	6188-2025B
25	M32 x 1,5	23	25	-	6188-2532N	6188-2532B
27-28	M32 x 1,5	26	25	6188-2732G	-	-
32	M40 x 1,5	30	25	-	6188-3240N	6188-3240B
40	M50 x 1,5	38	15	6188-4050G	6188-4050N	6188-4050B
50	M63 x 1,5	47	10	6188-5063G	6188-5063N	6188-5063B

ISO 228 GAS Cylindrical with locknut

Flexible conduit Ø d, mm	Dimensions, mm		Pack/pcs	RAL 7001 Code	Black Code	RAL 7035 Code
	F	Ø PU				
10	1/4"	8	50	6188-10G	6188-10N	6188-10B
10	3/8"	8	50	6188-101G	6188-101N	6188-101B
12	3/8"	10	50	6188-12G	6188-12N	6188-12B
15-16	1/2"	13	50	6188-15G	6188-15N	6188-15B
20	3/4"	18	50	6188-20G	6188-20N	6188-20B
25	1"	23	25	-	6188-251N	6188-251B
27-28	1"	26	25	6188-27G	6188-27N	-
32	1" 1/4	30	25	-	6188-32N	6188-32B
35	1" 1/4	33	20	6188-35G	6188-35N	-
40	1" 1/2	38	15	6188-40G	6188-40N	6188-40B
50	2"	47	10	6188-50G	6188-50N	6188-50B

PG without locknut

Flexible conduit Ø d, mm	Dimensions, mm		Pack/pcs	RAL 7001 Code	Black Code	RAL 7035 Code
	F	Ø PU				
10	09	8	50	6188-1009G	6188-1009N	6188-1009B
10	11	8	50	6188-1011G	6188-1011N	6188-1011B
12	11	10	50	6188-1211G	6188-1211N	6188-1211B
12	13	10	50	6188-1213G	6188-1213N	6188-1213B
15-16	13	13	50	6188-1513G	6188-1513N	6188-1513B
15-16	16	13	50	6188-1516G	6188-1516N	6188-1516B
20	21	18	50	6188-2021G	6188-2021N	6188-2021B
25	29	23	25	-	6188-2529N	6188-2529B
32	29	30	25	-	6188-3229N	6188-3229B
35	36	33	20	6188-3536G	6188-3536N	-
40	36	38	15	6188-4036G	6188-4036N	6188-4036B
50	48	47	10	6188-5048G	6188-5048N	6188-5048B

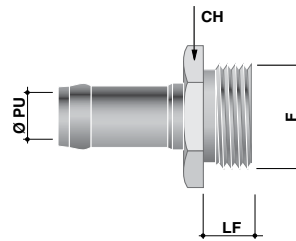
Connectors for smooth PVC flexible conduits - art. 6057

Characteristics:

Made of brass which is then nickel plated in order to improve resistance to the harsh environmental conditions in which they are used.

The connector is coupled to the flexible conduit by tightening a metal clamp that secures the conduit to the fitting. This clamp has a surface designed to prevent it from the slipping.

O-ring, part no. 6058, must be used with conduits sheathed in part no. 6089 steel braiding, as these are designed to contain the wires of the braiding. It is suggested in these situations to use clamps fitted with grounding screws, part no. 6059-T, to ensure an equipotential coupling. The particular care and attention that goes into producing these connectors ensures a perfect fitting of cables without any risks of coating damages.

Suggested threads are: ISO metric in compliance with CEI EN 60423, UNI ISO 228 GAS cylindrical, PG in accordance with DIN 40430.

Classification

Standard	CEI EN 61386
Protection degree	IP67 in compliance CEI EN 60529 (IEC 529 Standard)

Metric

Flexible conduit Ø d, mm	Dimensions, mm				Pack/pcs	Code
	F	Ø PU	CH	LF		
10	M12 x 1,5	8	19	7	20	6057-1012
10	M16 x 1,5	8	19	7	20	6057-1016
12	M16 x 1,5	10	22	10	20	6057-1216
15	M20 x 1,5	13	24	10	20	6057-1520
20	M20 x 1,5	16	27	10	10	6057-2020
20	M25 x 1,5	17	30	12	10	6057-2025
27	M25 x 1,5	21	35	12	10	6057-2725
27	M32 x 1,5	23	36	12	10	6057-2732
36	M32 x 1,5	26	44	12	5	6057-3632

PG

Flexible conduit Ø d, mm	Dimensions, mm				Pack/pcs	Code
	F	Ø PU	CH	LF		
10	09	8	19	7	20	6057-1009
12	11	10	22	7	20	6057-1211
12	13,5	10	24	7	20	6057-1213
15	13,5	13	24	7	20	6057-1513
20	13	16	27	7	10	6057-2013
20	16	16	27	7	10	6057-2016
27	21	23	36	10	10	6057-2821
36	29	30	45	11	5	6057-3529

ISO 228 GAS Cylindrical

Flexible conduit Ø d, mm	Dimensions, mm				Pack/pcs	Code
	F	Ø PU	CH	LF		
10	1/4"	8	19	7	20	6057-10
12	3/8"	10	22	10	20	6057-12
12	1/2"	10	24	10	20	6057-121
15	1/2"	13	24	10	20	6057-15
20	1/2"	16	27	10	10	6057-20
20	3/4"	17	30	12	10	6057-201
27	3/4"	21	36	12	10	6057-28
27	1"	23	36	12	10	6057-281
36	1"	26	44	12	10	6057-35
40	1" 1/4	35	50	13	5	6057-40

O-Ring Art. 6058



Conduit Ø d, mm	Pack/pcs	Code
10	20	6058-10
12	20	6058-12
15	20	6058-15
20	10	6058-20
27	10	6058-28
36	5	6058-35
40	5	6058-40
47	5	6058-47

Bushing of nickel plated brass - art. 66BOTT

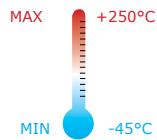
**System protection rating
IP40**

Classification:

 Manufactured in compliance with CEI EN 61386
 Electrical properties: Electrical continuity guaranteed

Characteristics:

Made of nickel plated brass, these specially shaped individual parts assure external blocking of the flexible conduit, guaranteeing a good mechanical seal and electrical continuity specified in CEI standards. They can be fitted onto any type of connector for metal flexible conduits, to replace the nylon bushing normally supplied as standard.

Ref. connectors Ø d flex. conduit	Ref. flex. cond. simple interlock.	Ref. flex. cond. double interlock.	Ref. flex. cond. double interlock.	Ref. flex. cond. double interlock.	Pack/pcs.	Code
10,0	667M1013	667DM10	-	667DXM10	50	66BOTT10
12,0	667M1215	667DM12	-	667DXM12	50	66BOTT12
15,5	667M1518	667DM15	667DXFTX16	667DXM16	50	66BOTT16
20,5	667M2024	667DM20	667DXFTX22	667DXM20	50	66BOTT20
26,5	667M2630	667DM26	667DXFTX32	667DXM26	50	66BOTT32
35,0	667M3539	667DM35	667DXFTX38	667DXM35	25	66BOTT38
40,0	667M4044	667DM40	667DXFTX40	667DXM40	25	66BOTT40
50,5	667M5054	667DM50	667DXFTX50	667DXM50	15	66BOTT50

Sealing couplings - art. 66BTP

Classification:

 Manufactured in compliance with CEI EN 61386-1, 61386-22 and 61386-23
 Self-extinguishing: Flame retardant (CEI EN 61386) - V0(UL94)
 RoHS Directive compliant 2002/95/CE
 Electrical properties: Electrical continuity guaranteed.

Characteristics

Manufactured of thermoplastic material, free of alogenee, silicon and cadmium substances. This solution increases the level of tightness to IP66/ IP67 in coupling between fittings and flexible metal coated vacuum. It can be used with any connector for flexible conduits, just wear the accessory end of the conduit.

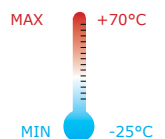
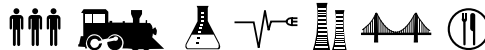
Areas of application

**System protection rating IP66/IP67
V0 (UL94)**

Ref. Ø d flexible conduit	Pack/pcs.	Code
10,0	12	66BTP10
12,0	12	66BTP12
15,5	6	66BTP16
20,5	4	66BTP22
26,5	4	66BTP32
35,0	4	66BTP38
40,0	4	66BTP40
50,5	2	66BTP50

Bushings - art. S66V



Characteristics

End accessories made from moulded sheet metal. These are screwed into the ends of the flexible metal conduits to prevent any contact between the cables and the edges of the conduit.



Ref. Ø d flexible conduit	Pack/ pcs.	Code
10,0	200	S66V10
12,0	200	S66V12
15,5	150	S66V16
20,5	100	S66V22
26,5	75	S66V32
35,0	50	S66V38
40,0	25	S66V40
50,5	10	S66V50